

Railroad-Highway Grade Crossing *Handbook*

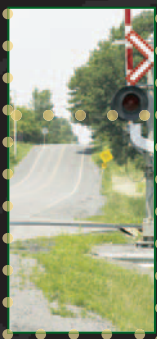

Revised Second Edition
August 2007

U.S. Department of Transportation
Federal Highway Administration

Notice

This document is disseminated under the sponsorship of the U.S. Department of Transportation in the interest of information exchange. The U.S. Government assumes no liability for the use of information contained in this document. This report does not constitute a standard, specification, or regulation.

The U.S. Government does not endorse products or manufacturers. Trademarks or manufacturers' names appear in this report only because they are considered essential to the objective of this document.

The contents of this report reflect the views of the authors, who are responsible for the facts and accuracy of the data presented herein. The contents do not necessarily reflect the official policy of the U.S. Department of Transportation.

Quality Assurance Statement

The Federal Highway Administration provides high-quality information to serve Government, industry, and the public in a manner that promotes public understanding. Standards and policies are used to ensure and maximize the quality, objectivity, utility, and integrity of its information. FHWA periodically reviews quality issues and adjusts its programs and processes to ensure continuous quality improvement.

Technical Report Documentation Page

1. Report No. FHWA-SA-07-010		2. Government Accession No.		3. Recipient's Catalog No.	
4. Title and Subtitle <i>Railroad-Highway Grade Crossing Handbook - Revised Second Edition 2007</i>				5. Report Date August 2007	
				6. Performing Organization Code	
7. Author(s)* Brent D. Ogden, Korve Engineering, a Division of DMJM+Harris				8. Performing Organization Report No.	
9. Performing Organization Name and Address Institute of Transportation Engineers 1099 14th Street, NW, Suite 300 West Washington, DC 20005				10. Work Unit No. (TR AIS)	
				11. Contract or Grant No. DTFH61-00-C-0003	
12. Sponsoring Agency Name and Address Office of Safety Design Federal Highway Administration 1200 New Jersey Avenue, SE Washington, DC 20590				13. Type of Report and Period Covered September 2004 to July 2007	
				14. Sponsoring Agency Code FHWA/HSSD	
15. Supplementary Notes: FHWA Contracting Officer's Task Order Manager: Guan Xu; ITE Project Manager: Lisa M. Fontana Tierney; FHWA Editor: Bonny Falk; Technical Editor: Clare L. James Notable contributions were made by: Kurt Anderson, Anita Boucher, Peggy Baer, George W. Black, Jr., Bill Browder, Rick Campbell, Anya A. Carroll, Debra Chappell, James Cheeks, Fred Coleman III, Andy Davis, R.W. Eck, Deborah Freund, Jim Gibson, Brian F. Gilleran, Joseph Glinsky Jr., Gerri Hall, Darin Kosmak, Tom R. Lancaster, Charles R. (Ray) Lewis II, Phillip R. Poichuk, Ron Ries, Amir Rizavi, Peter Rusch, Eugene R. Russell, Robert K. Seyfried, John T. Sharkey, Travis Tinken, Thomas P. Woll, and Tom R. Zeinz.					
16. Abstract The purpose of the <i>Railroad-Highway Grade Crossing Handbook – Revised Second Edition</i> is to provide a single reference document on prevalent and best practices as well as adopted standards relative to highway-rail grade crossings. The handbook provides general information on highway-rail crossings; characteristics of the crossing environment and users; and the physical and operational improvements that can be made at highway-rail grade crossings to enhance the safety and operation of both highway and rail traffic over crossing intersections. The guidelines and alternative improvements presented in this handbook are primarily those that have proved effective and are accepted nationwide. This handbook supersedes the <i>Railroad-Highway Grade Crossing Handbook</i> , published in September 1986. This update includes a compendium of materials that were included in the previous version of the handbook, supplemented with new information and regulations that were available at the time of the update. Updates were drawn from the current versions of relevant legislation, policy memoranda, Federal Register notices, and regulatory actions.					
17. Key Words Grade Crossing, Railroad, Traffic Control, Crossing Surfaces, Crossing Safety			18. Distribution Statement No restrictions. This document is available to the public through the National Technical Information Service, Springfield, Virginia 22161.		
19. Security Classif. (of this report) Unclassified		20. Security Classif. (of this page) Unclassified		21. No. of Pages 324	22. Price

SI* (MODERN METRIC) CONVERSION FACTORS

APPROXIMATE CONVERSIONS TO SI UNITS

Symbol	When You Know	Multiply By	To Find	Symbol
LENGTH				
in	inches	25.4	millimeters	mm
ft	feet	0.305	meters	m
yd	yards	0.914	meters	m
mi	miles	1.61	kilometers	km
AREA				
in ²	square inches	645.2	square millimeters	mm ²
ft ²	square feet	0.093	square meters	m ²
yd ²	square yard	0.836	square meters	m ²
ac	acres	0.405	hectares	ha
mi ²	square miles	2.59	square kilometers	km ²
VOLUME				
fl oz	fluid ounces	29.57	milliliters	mL
gal	gallons	3.785	liters	L
ft ³	cubic feet	0.028	cubic meters	m ³
yd ³	cubic yards	0.765	cubic meters	m ³
NOTE: volumes greater than 1000 L shall be shown in m ³				
MASS				
oz	ounces	28.35	grams	g
lb	pounds	0.454	kilograms	kg
T	short tons (2000 lb)	0.907	megagrams (or "metric ton")	Mg (or "t")
TEMPERATURE (exact degrees)				
°F	Fahrenheit	5 (F-32)/9 or (F-32)/1.8	Celsius	°C
ILLUMINATION				
fc	foot-candles	10.76	lux	lx
fl	foot-Lamberts	3.426	candela/m ²	cd/m ²
FORCE and PRESSURE or STRESS				
lbf	poundforce	4.45	newtons	N
lbf/in ²	poundforce per square inch	6.89	kilopascals	kPa

APPROXIMATE CONVERSIONS FROM SI UNITS

Symbol	When You Know	Multiply By	To Find	Symbol
LENGTH				
mm	millimeters	0.039	inches	in
m	meters	3.28	feet	ft
m	meters	1.09	yards	yd
km	kilometers	0.621	miles	mi
AREA				
mm ²	square millimeters	0.0016	square inches	in ²
m ²	square meters	10.764	square feet	ft ²
m ²	square meters	1.195	square yards	yd ²
ha	hectares	2.47	acres	ac
km ²	square kilometers	0.386	square miles	mi ²
VOLUME				
mL	milliliters	0.034	fluid ounces	fl oz
L	liters	0.264	gallons	gal
m ³	cubic meters	35.314	cubic feet	ft ³
m ³	cubic meters	1.307	cubic yards	yd ³
MASS				
g	grams	0.035	ounces	oz
kg	kilograms	2.202	pounds	lb
Mg (or "t")	megagrams (or "metric ton")	1.103	short tons (2000 lb)	T
TEMPERATURE (exact degrees)				
°C	Celsius	1.8C+32	Fahrenheit	°F
ILLUMINATION				
lx	lux	0.0929	foot-candles	fc
cd/m ²	candela/m ²	0.2919	foot-Lamberts	fl
FORCE and PRESSURE or STRESS				
N	newtons	0.225	poundforce	lbf
kPa	kilopascals	0.145	poundforce per square inch	lbf/in ²

*SI is the symbol for the International System of Units. Appropriate rounding should be made to comply with Section 4 of ASTM E380.
(Revised March 2003)

Table of Contents

I Overview	1
A. Background	1
1. Introduction to Highway-Rail Grade Crossings	1
2. Safety and Operations at Highway-Rail Grade Crossings	2
B. Highway-Rail Grade Crossing Programs	6
C. Responsibilities at Highway-Rail Grade Crossings	11
1. Fundamental Issues	11
2. Government Agency Responsibility and Involvement.....	13
3. Railroads	17
D. Legal Considerations Regarding Highway-Rail Grade Crossings	18
1. Background	18
2. Tort Liability and Standards	21
E. References	22
II Components of a Highway-Rail Grade Crossing	25
A. The Highway Component.....	25
1. Driver	25
2. Vehicle	27
3. Pedestrians	31
4. Roadway	32
5. Traffic Control Devices	33
B. Railroad Components	34
1. Train	34
QUIET ZONE RULE SUMMARY	37
Overview	37
Requirement to Sound the Locomotive Horn	38
Creation of Quiet Zones.....	38
Maintenance of Pre-Rule Quiet Zones	39
Creation of New Quiet Zones	39
Length of Quiet Zones.....	40
Supplementary and Alternative Safety Measures	40
Recognition of the Automated Wayside Horn.....	40
Special Circumstances.....	41
Other Provisions	41
2. Track	43
3. Signaling.....	45
C. References	45
III Assessment of Crossing Safety and Operation	47
A. Collection and Maintenance of Data	47
1. U.S. Department of Transportation Grade Crossing Inventory.....	47
2. Grade Crossing Collision Data.....	51
B. Hazard Indices and Accident Prediction Formulae.....	54
1. Hazard Index	54
2. U.S. Department of Transportation Accident Prediction Model	55
C. Engineering Study.....	62
1. Diagnostic Team Study Method	62
2. Traffic Conflict Technique.....	70
3. Collision Study.....	71
4. Traffic Study	71
5. Near-Hit Reports	71
6. Enforcement Study.....	71
D. Systems Approach	72
E. References	74
IV Identification of Alternatives	75
A. Existing Laws, Rules, Regulations, and Policies	75
B. Elimination	76
C. Grade Separation	77
D. Highway and Railroad Relocation	77
E. Closure	78
1. Closure Programs	80
2. Crossing Consolidation and Safety Programs.....	81
F. Abandoned Crossings	82
G. New Crossings.....	83
H. Passive Traffic Control Devices	83
1. Signs.....	84
2. Pavement Markings.....	95
I. Active Traffic Control Devices	97
1. Flashing Light Signals	99
2. Cantilevered Flashing Light Signals	100
3. Supplemental Flashing Light Signals	102
4. Light-Emitting Diode Flashing Light Signals.....	102
5. Automatic Gates	103
6. Four-Quadrant Gates	105
7. Use of Channelization with Gates	106
8. Barrier Gate	110
9. Warning Bell.....	110
10. Wayside Horn System	110
11. Active Advance Warning Sign	112
12. “Second Train Coming” Active Warning Sign	113
13. Active Turn Restriction Signs	113
14. New Traffic Signals	113
15. Preemption of Traffic Signals	114
16. Train Detection	114
PREEMPTION OF TRAFFIC SIGNALS NEAR RAILROAD CROSSINGS	115
17. Pre-Signals	129
18. Queue Prevention Strategies.....	134
J. Pedestrian and Bicycle Considerations	136
K. Roundabouts	136
L. Site and Operational Improvements	136
1. Removing Obstructions.....	136
2. Crossing Geometry	137
3. Illumination	141
4. Shielding Supports for Traffic Control Devices	141
M. Crossing Surfaces	141
N. Removal of Grade Separation Structures.....	142
O. References	143
V Selection of Alternatives	145
A. Technical Working Group Guidance on Traffic Control Devices—Selection Criteria and Procedure	145
TECHNICAL WORKING GROUP GUIDANCE	146
1. Minimum Devices	146
2. Minimum Widths	146
3. Passive—Minimum Traffic Control Applications	146

4. Active	148	G. ITS Applications	209
5. Closure	150	1. ITS National Architecture and User	
6. Grade Separation	151	Service 30	209
7. New Crossings	152	2. Standard 1570	210
8. Traffic Control Device Selection Procedure.....	153	3. Survey of Recent ITS Initiatives	210
B. Guidance on STOP and YIELD Signs	155	4. Proposed Demonstration Scenarios.....	213
C. Canadian Research on Cost Effectiveness	155	H. References	214
D. Economic Analysis Procedures	155	X Supporting Programs	215
1. Cost-Effectiveness Analysis	157	A. Driver Education and Enforcement	215
2. Benefit-Cost Ratio	158	B. Video Surveillance and Enforcement	217
3. Net Annual Benefit	158	C. Research and Development	218
E. Resource Allocation Procedure	161	D. References	219
F. Federal Railroad Administration GradeDec		Appendix A: Glossary	221
Software	163	Appendix B: Index.....	229
G. References	165	Appendix C: Example Crash Reporting Form,	
VI Implementation of Projects	167	State of Oklahoma.....	233
A. Funding.....	167	Appendix D: Example Hazardous Materials	
1. Federal Sources	167	Crash Reporting Form, U.S. Department of	
2. State Funding	169	Transportation Materials Transportation	
3. Local Agency Funding	169	Bureau	241
4. Railroad Funding	170	Appendix E: List of Selected Accident	
B. Agreements	170	Investigations, National Transportation Safety	
C. Accounting.....	171	Board.....	247
D. Design and Construction	172	Appendix F: New Hampshire Hazard Index,	
E. Traffic Control During Construction	173	NCHRP Report 50 Accident Prediction	
1. Traffic Control Zones	175	Formula, Peabody-Dimmick Accident	
2. Traffic Control Devices	177	Prediction Formula.....	249
3. Typical Applications	180	Appendix G: Diagnostic Team Crossing	
F. Program Development	184	Evaluation Reports, Examples from States...	253
G. References	184	Appendix H: State Crossing Consolidations	
VII Maintenance Program	185	and Closures	263
A. Railroad Responsibility	185	Appendix I: Preemption Calculation	
B. Highway Authority Responsibility	185	Procedures, Example From State Of Texas ...	277
1. Traffic Control Devices	185	Appendix J: Policy On Private Crossings, West	
2. Roadside Clear Zone.....	186	Virginia Example.....	297
3. Roadside Approaches	186	Appendix K: List of Highway-Rail Grade	
4. Reassessment and Periodic Review	186	Crossing Studies	301
C. References	186		
VIII Evaluation of Projects and Programs....	187		
A. Project Evaluation	187		
B. Program Evaluation	189		
C. Administrative Evaluation	189		
D. References	189		
IX Special Issues.....	191		
A. Private Crossings	191		
B. Short-Line Railroads	193		
C. Light-Rail Lines and Issues	194		
1. Motor Vehicle Turning Treatments	194		
2. Use of Crossbuck Sign with LRT	195		
3. Pedestrian Crossing Treatments	195		
4. Solutions to Observed Problems.....	201		
D. High-Speed Rail Corridors	205		
E. Special Vehicles, Pedestrians, Motorcycles, and			
Bicycles	205		
1. Trucks with Hazardous Material Cargo	205		
2. Long and Heavily Laden Trucks.....	206		
3. Buses.....	206		
4. Motorcycles and Bicycles.....	206		
F. Low-Cost Active Devices.....	208		

List of Figures

1. Reflectorization Example—Standards Applicable to Boxcars	42
2. Number of Collisions by Number of Trains per Day per Crossing.....	43
3. U.S. DOT Crossing Inventory Form	48
4. Crossing Identification Number Tag.....	50
5. Accident Report Form for Federal Railroad Administration	52
6. Sample Questionnaire for Diagnostic Team Evaluation	64
7. Study Positions for Diagnostic Team.....	65
8. Crossing Sight Distances	67
9. Sight Distance for a Vehicle Stopped at Crossing.....	68
10. Type III Barricade	80
11. Typical Crossing Signs.....	84
12. Crossing Sign (Crossbuck)	87
13. Supplemental Advance Warning Signs.....	91
14. Substandard Clear Storage Distance	91
15. Possible Sign System Where Sight Distance Is Limited On Approach to the Crossing.....	92
16. Typical Sign System Where STOP or YIELD at Crossing Is Required.....	92
17. Highway-Rail Grade Crossing (Crossbuck) Sign and STOP and YIELD Sign on Same Post.....	93
18. Highway-Rail Grade Crossing (Crossbuck) Sign and STOP and YIELD Sign on Separate Posts.....	94
19. Example of Placement of Warning Signs and Pavement Markings at Highway-Rail Grade Crossings.....	96
20. Alternate Pavement Markings at Highway-Rail Grade Crossings.....	97
21. Typical Supplemental Signing and Pavement Marking Treatment for Railroad Crossings.....	98
22. Typical Alignment Pattern for Flashing Light Signals with 30-15 Degree Roundel, Two-Lane, Two-Way Roadway	99
23. Typical Alignment Pattern for Flashing Light Signals with 20-32 Degree Roundel, Multilane Roadway	100
24. Typical Clearances for Flashing Light Signals with Automatic Gates.....	101
25. Typical Flashing Light Signal—Post Mounted.....	102
26. Typical Flashing Light Signal—Cantilevered	102
27. Use of Multiple Flashing Light Signals for Adequate Visibility Horizontal Curve to the Left	103
28. Use of Multiple Flashing Light Signals for Adequate Visibility Horizontal Curve to the Right	103
29. Typical Location of Signal Devices.....	105
30. Typical Location Plan, Right Angle Crossing, One-Way, Two Lanes	105
31. Typical Location Plan, Right Angle Crossing, One-Way, Three Lanes	106
32. Typical Location Plan, Divided Highway with Signals in Median, Two Lanes Each Way	106
33. Typical Location Plan, Divided Highway with Signals in Median, Three Lanes Each Way.....	107
34. Typical Location Plan, Divided Highway with Insufficient Median for Signals, Two Lanes Each Way	107
35. Typical Location Plan, Acute Angle Crossing for Divided Highway with Signals in Median, Two or Three Lanes Each Way	108
36. Typical Location Plan, Obtuse Angle Crossing for Divided Highway with Signals in Median, Two or Three Lanes Each Way.....	108
37. Example of Combination of Mountable and Non-Mountable Curbs from Illinois Department of Transportation	109
38. Example of Location Plan for Flashing Light Signals and Four-Quadrant Gates.....	111
39. Examples of Active Advance Warning Signs and Cantilevered Active Advance Warning Sign.....	112
40. Stand-By Power Arrangement.....	125
41. DC Track Circuit.....	125
42. Three-Track Circuit System	126
43. Track Circuits with Timing Sections	126
44. AC-DC Track Circuit.....	126
45. Audio Frequency Overlay Track Circuit	127
46. Motion-Sensitive Track Circuit, Bi-Directional Application	127
47. Motion-Sensitive Track Circuit, Uni-Directional Application	127
48. Constant Warning Time Track Circuit, Uni-Directional Application	128
49. Constant Warning Time Track Circuit, Bi-Directional Application.....	128
50. Pre-Signal Mounted on Railroad Cantilever, Rollins Road and State Route 83 at Wisconsin Central, Round Lake, Illinois.....	131

51. Pre-Signal Located Ahead of Grade Crossing with Displaced Stop Bar, S. Mary and W. Evelyn at Caltrain Commuter Line, Sunnyvale, California	131
52. Pre-Signal with Louvered Downstream Intersection Signal, Sierra and Orange at Metrolink Commuter Line, Fontana, California	132
53. Queue Cutter, Magnolia Street at Union Pacific Railroad, Riverside, California	133
54. Advance Head, Broadway and Arguello at Caltrain Commuter Line, Redwood City, California	134
55. Queue Prevention Strategies	135
56. Highway-Rail Grade Crossing Cross Section	140
57. Sample Cost-Effectiveness Analysis Worksheet	159
58. Sample Benefit-to-Cost Analysis Worksheet	160
59. Crossing Resource Allocation Procedure	162
60. Resource Allocation Procedure Field Verification Worksheet	164
61. Areas in a Traffic Control Zone	176
62. Typical Signs for Traffic Control in Work Zones	178
63. Use of Hand Signaling Devices by Flagger	181
64. Crossing Work Activities, Two-Lane Highway, One Lane Closed	182
65. Crossing Work Activities, Multi-Lane Urban Divided Highway, One Roadway Closed, Two-Way Traffic	182
66. Crossing Work Activities, Closure of Side Road Crossing	183
67. Crossing Work Activities, One Lane of Side Road Crossing Closed	183
68. Typical Private Crossing Sign	193
69. No Turns Internally Illuminated Signs	195
70. Placement of Flashing Light Signal Assemblies	196
71. Example Active Matrix Train Approaching Sign	196
72. Example Second Train Internally Illuminated Signs	197
73. ADA Dynamic Envelope Delineation in Sacramento, California	198
74. San Diego, California Curbside Pedestrian Barriers	198
75. Placement of Pedestrian Automatic Gates	199
76. Pedestrian Automatic Gate Examples	200
77. Pedestrian Swing Gate Examples	201
78. Bedstead Barrier Application	201
79. San Diego, California Pedestrian Z-Crossing	201
80. Illustrative Pedestrian Treatment	202
81. Recommended Sign and Marking Treatment for Bicycle Crossing	207
82. Highway-Rail Intersection Interface Overview	211
83. In-Vehicle Display	211

List of Tables

1. Railroad Line Miles and Track Miles	2
2. Public At-Grade Crossings by Functional Classification, 2005	3
3. Public At-Grade Crossings by Highway System, 2005.....	3
4. Fatalities at Public Crossings, 1920–2004.....	4
5. Collisions, Fatalities, and Injuries at Public Crossings, 1975–2004.....	5
6. State and Local Government Jurisdictional Authorities Concerned with Crossings	16
7. Public Crossings by Warning Device, 2004	26
8. Motor Vehicle Collisions and Casualties at Public Crossings by Vehicle Type, 2004.....	28
9. U.S. Customary Lengths for Design Vehicles	29
10. Metric Lengths for Design Vehicles	30
11. Highway-Rail Grade Crossing Collision Fatalities versus Trespasser Fatalities, 1995–2004	31
12. Collisions at Public Crossings Involving Motor Vehicles by Type of Train, 2004.....	43
13. Maximum Train Speeds by Class of Track.....	44
14. Public At-Grade Crossings by Type of Track, 2005	45
15. Track Class and Permissible Speeds.....	46
16. U.S. DOT Collision Prediction Equations for Crossing Characteristic Factors.....	56
17. U.S. DOT Accident Prediction Factor Values for Crossings with Passive Warning Devices	57
18. U.S. DOT Accident Prediction Factor Values for Crossings with Flashing Light Warning Devices	57
19. U.S. DOT Accident Prediction Factor Values for Crossings with Gate Warning Devices	58
20. U.S. DOT Final Accident Prediction from Initial Prediction and Accident History (1 year of accident data (T=1))	58
21. U.S. DOT Final Accident Prediction from Initial Prediction and Accident History (2 years of accident data (T=2)).....	59
22. U.S. DOT Final Accident Prediction from Initial Prediction and Accident History (3 years of accident data (T=3)).....	59
23. U.S. DOT Final Accident Prediction from Initial Prediction and Accident History (4 years of accident data (T=4)).....	60
24. U.S. DOT Final Accident Prediction from Initial Prediction and Accident History (5 years of accident data (T=5)).....	60
25. Equations for Crossing Characteristic Factors for U.S. DOT Fatal Accident Probability Formula	61
26. Equations for Crossing Characteristic Factors for U.S. DOT Injury Accident Probability Formula	61
27. Factor Values for U.S. DOT Fatal Accident Probability Formula	61
28. Factor Values for U.S. DOT Injury Accident Probability Formula.....	62
29. Distances in Meters to Establish Study Positions for Diagnostic Team Evaluation.....	63
30. Distances in Feet to Establish Study Positions for Diagnostic Team Evaluation.....	65
31. Sight Distances for Combinations of Highway Vehicle and Train Speeds, Metric.....	69
32. Sight Distances for Combinations of Highway Vehicle and Train Speeds, U.S. Customary.....	69
33. Federal Laws, Rules, Regulations, and Policies.....	75
34. Responsibility for Closing Public Crossings.....	79
35. Current MUTCD Devices.....	85
36. Placement Distances for Advance Warning Signs (English Units).....	89
37. Placement Distances for Advance Warning Signs (Metric Units).....	90
38. Minimum Sight Distance Table (English Units).....	95
39. Minimum Sight Distance Table (Metric Units).....	95
40. Effectiveness of Active Crossing Warning Devices	99
41. Clearing Sight Distance (in feet).....	138
42. Guidelines for Active Devices	148
43. LRT Grade Separation	152
44. Countermeasure Type, Effectiveness, and Cost	156
45. Comparison of Cost-Effectiveness, Benefit-Cost, and Net Benefit Methods	162
46. Effectiveness/Cost Symbol Matrix.....	162
47. Collision Prediction and Resource Allocation Procedure Normalizing Constants	163
48. Channelizing Devices for Tapers	177
49. Sign Spacing for Urban Areas.....	180

50. Collisions at Private Crossings, 2000–2004 192
51. Collisions at Private Crossings by Roadway User, 2004 192
52. Motor Vehicle Collisions at Private Crossings by Traffic Control Device, 2004 192
53. Use of Active Internally Illuminated Signs for Parallel Traffic Turning Across LRT Tracks..... 195
54. Possible Solutions to Observed Problems..... 203

Overview



The purpose of the *Railroad-Highway Grade Crossing Handbook—Revised Second Edition* is to provide a single reference document on prevalent and best practices as well as adopted standards relative to highway-rail grade crossings. The handbook provides general information on highway-rail crossings; characteristics of the crossing environment and users; and the physical and operational improvements that can be made at highway-rail grade crossings to enhance the safety and operation of both highway and rail traffic over grade crossings. The guidelines and alternative improvements presented in this handbook are primarily those that have proven effective and are accepted nationwide.

The revised second edition of the handbook supersedes the *Railroad-Highway Grade Crossing Handbook—Second Edition* published in September 1986. This update includes materials that were included in the previous version of the handbook, supplemented with new information that was available at the time of the update. Decisions regarding the selection, configuration, modification, and construction of improvements at highway-rail grade crossings should reflect the policies and standards of the affected railroad(s) and involved jurisdictions, including state-level agencies, and should address these specific requirements in applying the general principles and practices provided in this manual.

A. Background

1. Introduction to Highway-Rail Grade Crossings

The highway-rail grade crossing is unique in that it constitutes the intersection of two transportation modes, which differ in both the physical characteristics of their traveled ways and their operations.

Railroad transportation in the United States had its beginning during the 1830s and became a major factor in accelerating the great westward expansion of the country by providing a reliable, economical, and rapid method of transportation. Today, railroads are major movers of coal; ores; minerals; grains and other farm products; chemicals and allied products; food and kindred products; lumber and other forest products; motor vehicles and equipment; and other bulk materials and products.

In addition, railroads contribute to the movement of non-bulk intermodal freight, which also moves by water and highway during the journey from origin to destination. Finally, although few privately-operated passenger services operate on Class I railroads, publicly-funded long distance, corridor, and commuter services as well as light-rail transit lines all may operate through grade crossings.

As additional railroad lines were built and extended, they facilitated the establishment and growth of towns in the midwest and west by providing a relatively rapid means of transporting goods and people. Towns depended on the railroads and, therefore, were developed along railroad lines. The federal government and certain states encouraged westward expansion of the railroads and supported them financially by land grants and loans. The federal government enjoyed reduced freight rates on its cargoes for many years as a result of these land grants.

In the east, railroads were built to serve existing towns and cities. Many communities wanted a railroad, and certain concessions were made to obtain one. Railroads were allowed to build their tracks across existing streets and roads at grade, primarily to avoid the high capital costs of grade separations. As people followed the railroads west, there was a need for new

Table 1. Railroad Line Miles and Track Miles

Year	Line miles	Track miles
1929	229,530	381,417
1939	220,915	364,174
1947	214,486	355,227
1955	211,459	350,217
1960	207,334	340,779
1970	196,479	319,092
1980	164,822	270,074
1990	119,758	200,074
1991	116,626	196,081
1992	113,056	190,591
1993	110,425	186,288
1994	109,332	183,685
1995	108,264	180,419
1996	105,779	176,978
1997	102,128	172,564
1998	100,570	171,098
1999	99,430	168,879
2000	99,250	168,535
2001	97,817	167,275
2002	100,125	170,048
2003	99,126	169,069

Source: "Railroad Facts." Washington, DC: Association of American Railroads, 2004.

highways and streets, most of which, primarily for economic reasons, crossed the railroads at grade.

The number of railroad line miles grew until a peak was reached in 1920, when 252,845 miles of railroad line were in service. Track miles are defined as the total centerline length of mainline trackage in a corridor. The number of railroad line miles and track miles has been decreasing since the 1930s, as shown in Table 1.

Initially, safety at highway-rail grade crossings was not considered a problem. Trains were few in number and slow, as were highway travelers who were usually on foot, horseback, horse-drawn vehicles, or cycles. By the end of the century, crossing collisions were increasing and communities became concerned about safety and delays at crossings. Many states, cities, and towns adopted laws, ordinances, and regulations that required the railroads to eliminate some crossings and provide safety improvements at others.

Highway-rail grade crossings became more of a concern with the advent of the automobile in the early 1900s. By 1920, vehicles traveled approximately 45 billion miles annually. Vehicle miles of travel increased more than 66-fold during the intervening 85 years to approximately 3 trillion vehicle miles in 2004.¹ More recently, vehicle miles of travel have been increasing at a rate of approximately 3.1 percent per year. Road mileage also grew during those 85 years to approximately 3.99 million miles in 2004.²

The number of highway-rail grade crossings grew with the growth in highway miles. In cities and towns, the grid method of laying out streets was utilized, particularly in the midwest and west. A crossing over the railroad was often provided for every street, resulting in about 10 crossings per mile. In 2005, there were 248,273 total intersections of vehicular and pedestrian traveled ways with railroads. This equates to approximately 2.4 crossings per railroad line mile.

Crossings are divided into categories. Public crossings are those on highways under the jurisdiction of and maintained by a public authority and open to the traveling public. In 2005, there were 181,886 public crossings, of which 147,805 were at grade and 34,081 were grade separated. Private crossings are those on roadways privately owned and utilized only by the landowner or licensee. There were 97,306 private crossings in 2005. Pedestrian crossings are those used solely by pedestrians. There were 3,162 pedestrian crossings in 2005.

Sixty-one percent, or 90,274 of public at-grade crossings were located in rural areas, compared to 57,531 in urban areas. For both urban and rural areas, the majority of crossings are located on local roads, as depicted in Table 2. Twenty-one percent of public at-grade crossings are located on federal-aid highways, as shown in Table 3.

2. Safety and Operations at Highway-Rail Grade Crossings

National statistics on crossing collisions have been kept since the early 1900s as a result of the requirements of the Accident Reports Act of 1910. The act required rail carriers to submit reports of collisions involving railroad personnel and railroad equipment, including those that occurred at crossings. Not all

1 Federal Highway Administration (FHWA) Website (www.fhwa.dot.gov).

2 Bureau of Transportation Statistics (BTS) Website (www.bts.gov).

Table 2. Public At-Grade Crossings by Functional Classification, 2005

Functional classification	Number
Rural	
Interstate*	40
Other principal arterial	1,176
Minor arterial	3,515
Major collector	11,159
Minor collector	8,865
Local	65,515
Not reported	4
Total – Rural	90,274
Urban	
Interstate* and other limited access	381
Other principal arterial	5,500
Minor arterial	10,227
Collector	10,384
Local	31,039
Total – Urban	57,531
Grand total	147,805

* Note: Crossings classified as “Interstate” are typically located on ramps.

Source: Unpublished data from Federal Railroad Administration.

Table 3. Public At-Grade Crossings by Highway System, 2005

Highway System	Number
Interstate*	246
Federal-aid	31,057
Non-federal-aid	109,624
National Highway System	6,868
Not reported	10
Total	147,805

*Note: Crossings classified as “Interstate” are typically located on ramps.

Source: Unpublished data from Federal Railroad Administration.

crossing collisions were reported because the railroads were required to report only those collisions that resulted in:

- A fatality;
- An injury to a person sufficient to incapacitate him or her for a period of 24 hours in the aggregate during the 10 days immediately following; or
- More than \$750 in damage to railroad equipment, track, or roadbed.

These reporting requirements remained essentially the same until 1975, when the Federal Railroad Administration (FRA) redefined a reportable highway-rail grade crossing collision. Under the new guidelines, any impact “between railroad on-track equipment and an automobile, bus, truck, motorcycle, bicycle, farm vehicle, pedestrian or other highway user at a rail-highway crossing” must be reported.³

Table 4 gives the number of fatalities occurring at public highway-rail grade crossings from 1920 to 2004. Also shown separately are fatalities resulting from collisions involving motor vehicles. Table 5 provides data on the number of collisions, injuries, and fatalities at public highway-rail grade crossings for the period from 1975 to 2004. Collisions and injuries from 1920 to 1974 are not provided because not all collisions and injuries were required to be reported during those years.

The variation in the number of motor vehicle fatalities appears to be related to various occurrences over the years. From 1920 to 1930, railroad expenditures for the construction of grade separations and crossing active traffic control devices were extensive. During the early four-year period of the depression, railroad expenditures for crossing improvements lagged, and the number of motor vehicle fatalities increased. Starting in 1935, some special federal programs were initiated to improve crossing safety, and the number of motor vehicle fatalities began to decrease. During the war period of the 1940s, crossing improvement work was greatly reduced, and the number of motor vehicle fatalities remained fairly constant. Since 1946, federal aid has increased, and the number of motor vehicle fatalities at crossings has been decreasing correspondingly.

During the period between 1960 and 1967, the number of fatalities increased in spite of continual federal

³ Highway Crossing Accident/Incident and Inventory Bulletin (No.6 Calendar Year 1983). Washington, DC: Federal Railroad Administration (FRA), 1984.

Table 4. Fatalities at Public Crossings, 1920–2004

Year	All fatalities	Motor vehicle fatalities	Year	All fatalities	Motor vehicle fatalities	Year	All fatalities	Motor vehicle fatalities
1920	1,791	1,273	1950	1,576	1,410	1980	788	708
1921	1,705	1,262	1951	1,578	1,407	1981	697	623
1922	1,810	1,359	1952	1,407	1,257	1982	580	526
1923	2,268	1,759	1953	1,494	1,328	1983	542	483
1924	2,149	1,688	1954	1,303	1,161	1984	610	543
1925	2,206	1,784	1955	1,446	1,322	1985	537	480
1926	2,491	2,062	1956	1,338	1,210	1986	578	507
1927	2,371	1,974	1957	1,371	1,222	1987	598	533
1928	2,568	2,165	1958	1,271	1,141	1988	652	594
1929	2,485	2,085	1959	1,203	1,073	1989	757	682
1930	2,020	1,695	1960	1,364	1,261	1990	648	568
1931	1,811	1,580	1961	1,291	1,173	1991	565	497
1932	1,525	1,310	1962	1,241	1,132	1992	536	466
1933	1,511	1,305	1963	1,302	1,217	1993	584	517
1934	1,554	1,320	1964	1,543	1,432	1994	572	501
1935	1,680	1,445	1965	1,534	1,434	1995	524	455
1936	1,786	1,526	1966	1,780	1,657	1996	449	377
1937	1,875	1,613	1967	1,632	1,520	1997	419	378
1938	1,517	1,311	1968	1,546	1,448	1998	385	325
1939	1,398	1,197	1969	1,490	1,381	1999	363	309
1940	1,808	1,588	1970	1,440	1,362	2000	369	306
1941	1,931	1,691	1971	1,356	1,267	2001	386	315
1942	1,970	1,635	1972	1,260	1,190	2002	316	271
1943	1,732	1,396	1973	1,185	1,077	2003	300	249
1944	1,840	1,520	1974	1,220	1,128	2004	330	252
1945	1,903	1,591	1975	978	788			
1946	1,851	1,575	1976	1,114	978			
1947	1,790	1,536	1977	944	846			
1948	1,612	1,379	1978	1,021	929			
1949	1,507	1,323	1979	834	727			

Source: Federal Railroad Administration Safety Data Website (safetydata.fra.dot.gov/officeofsafety).

funding for grade separations and crossing traffic control device improvements. A national concern for crossing safety developed, as witnessed by national conferences to address the increase in casualties. The U.S. Congress responded by establishing a categorical funding program for crossing safety improvements in the 1973 Highway Act. This categorical safety program was extended in the 1976 Highway Act and the 1978 and 1982 Surface Transportation Acts. The result of this safety program and other emphases on crossing safety is demonstrated in Tables 4 and 5, which show the dramatic reduction in the number of fatalities involving motor vehicles.

Approximately 6.3 million motor vehicle traffic collisions occurred in 2002. Crossing collisions accounted for 0.05 percent of all motor vehicle

collisions on public roads. However, the severity of crossing collisions demands special attention. In 2002, there were 318 motor vehicle fatalities at crossings and a total of 42,452 motor vehicle fatalities. Therefore, crossing fatalities accounted for 0.8 percent of all motor vehicle fatalities. One out of every 149 vehicle collisions resulted in a fatality, but one out of every 10 crossing collisions resulted in a fatality.⁴

In addition to the possibility of a collision between a train and a highway user, a highway-rail grade crossing presents the possibility of a collision that does not involve a train. Non-train collisions include rear-end collisions in which a vehicle that has stopped at a crossing is hit from the rear; collisions with fixed objects such as signal equipment or signs; and non-collision

⁴ BTS Website (www.bts.gov).

Table 5. Collisions, Fatalities, and Injuries at Public Crossings, 1975–2004

Year	Collisions	Fatalities	Injuries
1975	11,409	888	3,736
1976	12,374	1,066	4,535
1977	12,595	944	4,646
1978	12,667	1,018	4,260
1979	11,777	834	4,172
1980	9,926	788	3,662
1981	8,698	697	3,121
1982	7,324	580	2,508
1983	6,691	542	2,467
1984	6,798	610	2,723
1985	6,497	537	2,508
1986	5,965	578	2,328
1987	5,891	598	2,313
1988	6,027	652	2,417
1989	5,980	757	2,683
1990	5,235	648	2,254
1991	4,863	565	1,923
1992	4,465	536	1,830
1993	4,437	584	1,744
1994	4,503	572	1,829
1995	4,153	524	1,754
1996	3,788	449	1,486
1997	3,414	419	1,370
1998	3,086	385	1,179
1999	3,090	363	1,262
2000	3,032	369	1,079
2001	2,843	386	1,038
2002	2,709	316	866
2003	2,597	299	918
2004	2,623	331	931

Source: Federal Railroad Administration Safety Data Website (safetydata.fra.dot.gov/officeofsafety).

accidents in which a driver loses control of the vehicle.

These non-train collisions are a particular concern with regard to the transportation of hazardous materials by truck and the transportation of passengers, especially on school buses. Drivers of these “special vehicles” are, under federal regulation and many state laws, required to stop at all crossings and look and listen for a train before proceeding to cross the tracks. The driver of a vehicle following a special vehicle may not expect to stop and may rear-end the vehicle, perhaps resulting in a catastrophic collision.

The current practices of existing railroads in general are to consolidate and close grade crossings where feasible. The creation of new at-grade crossings is not a preferred approach to addressing highway mobility. Grade crossing closure initiatives have contributed to improved safety and are discussed in Chapter IV.

Although safety is a primary concern, highway-rail grade crossings affect the public and railroads in other ways. In the 19th century, most communities and cities welcomed and actively encouraged the construction of railroad lines to and within the community. As the benefits of this transportation service were realized, the communities and the railroad system within communities grew. Today, highway-oriented transportation provides much of the service needed for commercial and other land uses in and near central cities. Newer industrial developments that need rail transportation are frequently located in outlying areas.

Historically, railroads came into the centers of communities because the railroads were first or because communities wanted the railroads to provide transportation to the rest of the country. In today’s environment, especially with high vehicular traffic, conflicts have arisen over railroads’ location in central cities.

From the community viewpoint, railroads are now a dividing force providing delays, congestion, and concerns over emergency vehicle response while trains are moving through, blocking many street crossings. Some communities impose speed restrictions on trains, exacerbating the delays because trains take longer to clear crossings.

From the railroad viewpoint, speed restrictions are undesirable because of the delays incurred by trains slowing down to pass through the community. However, the central city location has an advantage. Its right of way may be attractive to power companies who wish to reach electric customers in the city. Hence, railroads may lease space for electric power transmission lines. Also, with the new development of fiber optic cables for high-capacity communications services, communications carriers are also finding railroad rights of way into center cities very attractive. Finally, rail alignments through urban centers provide station locations with convenient access to central-city destinations. Thus, on the positive side, communities and railroads both are finding advantages in communicating and cooperating with each other on this mutual situation.

Construction activities on public roadways, nominally within 25 feet of an active rail track, and proposed roadway modifications, nominally within 10 feet of an active rail track, should include consideration for the procedures applicable to design and construction of improvements within railroad rights of way as well as any provisions solely applicable to construction within the roadway right of way.

B. Highway-Rail Grade Programs*

The first authorization of federal funds for highway construction in modern times occurred in 1912, when Congress allocated \$500,000 for an experimental rural post road program. The Federal-Aid Road Act of 1916 provided federal funds to the states for the construction of rural post roads. These funds could be expended for safety improvements at highway-rail grade crossings as well as for other highway construction. The states had to match the federal funds on a 50-50 basis and often required railroads to pay the state's 50-percent share or more.

The Federal-Aid Highway Act of 1921 provided funds with similar provisions, except that the expenditure of federal funds was limited to a connected system of principal roads, which was the predecessor of the former Federal-Aid Primary Highway System and of the current National Highway System.

The Depression era of the 1930s brought about a change in railroad and highway traffic volumes and created a need for federal assistance to improve safety as well as to provide employment throughout the United States. Congress passed the National Industrial Recovery Act in 1933, which, among other things, authorized the president to provide grants totaling \$300 million to the states to be used in paying any or all of the costs of eliminating the hazards of highway-rail grade crossings. The states did not have to provide matching funds, and the improvements did not have to be made at crossings on the Federal-Aid Highway System.

The Hayden-Cartwright Act of 1934 authorized additional funds for the construction of highway-rail grade separations and traffic control devices at crossings. Federal funds were available for initial construction costs but not for right-of-way costs or maintenance. Other federal-aid highway funds were provided in the Emergency Relief Act of 1935, the Authorization and Amendment Act of 1936, the Federal-Aid Highway Act of 1938, and the Federal Highway Act of 1940. In spite of these efforts to eliminate crossings, the number of crossings steadily increased due to the number of highway construction projects being carried out during the same period.

The Federal-Aid Highway Act of 1944 authorized the expenditure of federal funds for federal-aid highways in urban areas, provided for the designation of a Federal-Aid Secondary System, and made the first

provisions for a national system of interstate highways. Although states had to provide 50-percent matching funds for expenditures on primary, secondary, and urban systems, the entire cost for the elimination of highway-rail grade crossing hazards on federal-aid systems could be paid from federal funds. However, no more than 50 percent of the right-of-way and property-damage costs could be paid with federal funds. In addition, no more than 10 percent of the total funds apportioned to each state in any given year could be used for crossing projects on a reimbursable basis of up to 100 percent.

In 1956, Congress established the National System of Interstate and Defense Highways. This same act ushered in the modern era of highway funding by establishing the Highway Trust Fund. The design criteria for interstate highways, approved July 17, 1956 by the U.S. Department of Commerce, Bureau of Public Roads, stated that railroad crossings were to be eliminated for all through traffic lanes.

In 1962, the Interstate Commerce Commission conducted an investigation of highway-rail grade crossing safety. It concluded that the public was now responsible for crossing safety and recommended that Congress take appropriate action by stating:

Since the Congress has the authority to promulgate any necessary legislation along this line it is recommended that it give serious study and consideration to enactment of legislation with a view to having the public including the principal users, assume the entire cost of rail-highway grade crossing improvements or allocating the costs equitably between those benefited by the improvements.⁵

In 1970, Congress passed two acts, the Highway Safety Act and the Federal Railroad Safety Act, which contained specific provisions concerning highway-rail grade crossings. The Highway Safety Act of 1970 authorized two demonstration projects, one for the elimination of at-grade crossings along the high-speed rail passenger Northeast Corridor between Washington, DC, and Boston, Massachusetts, and the other for the elimination of crossings or the installation of traffic control devices at public crossings in

* "Geometric Design Standards for the National System of Interstate and Defense Highways." Washington, DC: U.S. Department of Commerce, Bureau of Public Roads, approved July 17, 1956.

⁵ *Prevention of Rail-Highway Grade Crossing Accidents Involving Railway Trains and Motor Vehicles.* Washington, DC: Interstate Commerce Commission (ICC), November 1962.

and near Greenwood, South Carolina.⁶ The act provided \$31 million for these demonstration projects.

The Railroad Safety Act of 1970 required the secretary of transportation to undertake “. . . a comprehensive study of the problem of eliminating and protecting grade crossings” and to provide “recommendations for appropriate action, including, if relevant, a recommendation for equitable allocation of the economic costs of any such program proposed as a result of such study.”⁷ Similarly, the Highway Safety Act of 1970 called for “. . . a full and complete investigation and study of the problem of providing increased highway safety at public and private ground-level rail-highway crossings . . . including the estimate of the cost of such a program.”

The Federal Highway Administration (FHWA) and FRA prepared a two-part report to satisfy the requirements of the legislation. Part I discussed the crossing safety problem; Part II provided crossing improvement recommendations, one of which was a federal funding program exclusively for crossings. The secretary also recommended that the U.S. Department of Transportation (U.S. DOT), in cooperation with the railroad industry and appropriate state agencies, develop a national inventory of and uniform national numbering system for crossings. In addition, the secretary recommended emphasizing highway-rail grade crossing safety research and furthering efforts to educate drivers regarding the potential hazards of crossings. The report was presented in November 1971.⁸

Over the next two years, there were three significant regulatory actions by FHWA in the area of highway-rail crossings:

- May 3, 1972: FHWA reissued Policy and Procedure Memorandum 21-16, Highway Safety Improvement Program (HSIP). States were required for the first time to include highway-rail grade crossing projects as an integral part of their safety programs.⁹
- October 27, 1972: FHWA issued Instructional Memorandum 21-5-72, which dealt with railroad cost liability on projects and stated that the installation or improvement of grade

crossing protective devices was found to be of no net ascertainable benefit to the railroad. Therefore, the railroad was to be assigned no liability in the costs of such work.¹⁰

- March 14, 1973: FHWA issued a notice defining the improvement of grade crossing surfaces as having safety benefits.¹¹

Based on the recommendations of the 1971 study, Congress, in the Highway Safety Act of 1973, established a categorical safety program for the elimination or alleviation of hazards at rail-highway grade crossings.¹² Section 203 of the act authorized \$175 million from the Highway Trust Fund for crossing improvements on the Federal-Aid Highway System. The federal share of improvement costs was set at 90 percent.

This act also established funds for other categorical safety programs that could be used for crossing improvements at the states’ discretion. Section 230 established the Safer Roads Demonstration Program, which provided funds for safety improvements off the Federal-Aid Highway System. Funds for this program were available for three types of safety projects: to eliminate or alleviate hazards at rail-highway grade crossings; to improve high-hazard locations; and to eliminate roadside obstacles. The Pavement Marking Demonstration Program, Section 205, provided funds for pavement markings on any public road. The Federal-Aid Highway Amendments of 1974 added Section 219, which provided funds for the construction, reconstruction, and improvement of highways off the Federal-Aid Highway System.

The Federal-Aid Highway Act of 1973, Section 163, established a demonstration program to eliminate highway-rail conflicts in specified urban areas.¹³ Additional funds were provided in the Federal-Aid Highway Amendments of 1974, the National Mass Transportation Assistance Act of 1974, the Federal-Aid Highway Act of 1976, and the Surface Transportation Assistance Acts of 1976 and 1978.

These demonstration projects were intended to determine the feasibility of increasing highway safety by the relocation, consolidation, or separation of rail lines in center-city areas. The funds were available on a 95-percent to 5-percent matching ratio, with state or local governments providing the matching share.

6 Highway Safety Act of 1970, §§ 201-205, Public Law No. 91-605, 84 Stat. 1742.

7 Railroad Safety Act of 1970, Public Law No. 91-458, 84 Stat. 971.

8 *Railroad-Highway Safety, Part I: A Comprehensive Statement of the Problem, A Report to Congress*. Washington, DC: U.S. Department of Transportation (U.S. DOT), November 1971.

9 FHWA. Policy and Procedure Memorandum 21-16, “Highway Safety Improvement Program,” May 3, 1972.

10 FHWA. Instructional Memorandum 21-5-72, “Elimination of Hazards of Railway-Highway Crossings—Railroad Liability,” October 27, 1972.

11 FHWA Notice. “Elimination of Hazards, Railroad-Highway Grade Crossings—Improvement of Crossing Surface,” March 14, 1973.

12 Highway Safety Act of 1973, Public Law 93-87, 87 Stat. 250.

13 *Ibid*.

By 1975, all public and private crossings had been surveyed in the U.S. DOT National Highway-Rail Crossing Inventory Program. This inventory showed that the majority of crossings, 77 percent, were located off the Federal-Aid Highway System and, therefore, were not eligible for improvement with federal funds from the Section 203 program. In 1976, Congress extended the Section 203 program to all public crossings. The legislation authorized an additional \$250 million from the Highway Trust Fund for crossings on the Federal-Aid Highway System and \$168.75 million from the general fund for crossings off the Federal-Aid Highway System.

The Surface Transportation Assistance Act of 1978 continued the Section 203 categorical program by providing \$760 million for safety improvements at any public crossing—eliminating the distinction between crossings on and off the Federal-Aid Highway System.

In 1982, Congress again continued the highway-rail grade crossing safety program in the Surface Transportation Assistance Act of 1982. This act provided \$760 million over the four fiscal years from 1983 through 1986.

The Surface Transportation Assistance Act of 1987 established Section 130 of Chapter 23 of the United States Code, giving the Federal-Aid Rail-Highway Grade Crossing Safety Program permanent status under the law for the first time.¹⁴

Section 130 funds were apportioned to the states in the following manner: 50 percent was apportioned to each of the states according to the ratio of the number of public crossings in the state to the number of public crossings in the country. The remainder was apportioned to the states on the basis of area, population, and road mileage. The apportionment of federal funds for crossing safety was divided in half: half was required to be used for traffic control devices at crossings (139, or RRP Funds); the other half was available for any type of crossing safety improvements (138, or RRS Funds).

In 1991, Congress passed the Intermodal Surface Transportation Efficiency Act (ISTEA). This act established the National Highway System and Surface Transportation Program (STP). The National Highway System consists of the interstate system and other highways of national significance, plus certain intermodal connections; the STP covers all other public roads and streets.

Section 1007(d)(1) of ISTEA requires that 10 percent of each state's STP funds be set aside for safety improvements under Sections 130 and 152 (Hazard Elimination) of Title 23. It further requires that the state shall reserve in each fiscal year an amount not less than the amount apportioned in each program for fiscal year 1991. If the total set aside is more than the 1991 total for these programs, the surplus must be used for safety but may be used for either program; if the total is less than the total 1991 apportionment, the safety set-aside funds are to be used proportionately for each program. ISTEA therefore provided for the continuation of categorical safety programs.¹⁵

ISTEA removed the potential to fund railroad grade separations as 100 percent, or G-funded projects. It also reduced the percentage of a state's federal funds that could be used for G-funded work from 25 percent, which had been in effect for many years, to 10 percent.

ISTEA also authorized the expenditure of \$16.1 billion for the continuation of the on- and off-system Bridge Replacement and Rehabilitation Program. All bridges carrying highway traffic on public roads, regardless of ownership or maintenance responsibility, are eligible for improvement or replacement under this program. This includes bridges owned by railroads.¹⁶

The matching ratio for federal funds set aside under Section 1007(d)(1) is the same as that previously available for the categorical safety programs: 90 percent federal and 10 percent state or local. Section 203(f) of the Highway Safety Act of 1973 provided a mechanism for increasing the federal share where both local and state funds were incorporated into a railroad project; however, this was impractical in practice due to the highway authorization or enabling legislation in effect in most states.

Section 1021(c) of ISTEA permits an increased federal share on certain types of safety projects, including traffic control signalization; pavement marking; commuter carpooling and vanpooling; or installation of traffic signs, traffic lights, guardrails, impact attenuators, concrete barrier end treatments, breakaway utility poles, or priority control systems for emergency vehicles at signalized intersections. FHWA has determined that railroad grade crossing signals are included in traffic control signalization. In 1995, Congress passed the National Highway System Designation Act, which included a provision that made any activities associated with the closure of a highway-

14 Surface Transportation Assistance Act of 1987, Public Law 100-17, 101 Stat. 171.

15 Intermodal Surface Transportation Efficiency Act of 1991, Public Law 102-240.

16 *Ibid.*

railroad grade crossing eligible for 100-percent federal funding.

Congress enacted the Transportation Equity Act for the 21st Century (TEA-21) in 1997. This act extended the funding arrangements (safety set-asides and other provisions) that had been established in ISTEA and the National Highway System Designation Act.

In the summer of 2005, Congress passed the Safe, Accountable, Flexible, Efficient Transportation Equity Act—A Legacy for Users (SAFETEA-LU), which was signed into law by the President on August 10, 2005.

SAFETEA-LU requires that each state develop a Strategic Highway Safety Plan (SHSP), which addresses engineering, management, education, enforcement, and emergency service elements of highway safety as key factors in evaluating highway safety projects. Highway-rail grade crossing safety is to be considered part of the SHSP.

SAFETEA-LU created the new HSIP, elevating it to a new core federal-aid funding program beginning in fiscal year 2006 to achieve a significant reduction in traffic fatalities and serious injuries on all public roads. This new program replaces the 10-percent safety set-aside program element of the STP established under ISTEA. It also restored categorical funding for each of the highway safety construction programs. SAFETEA-LU continues the Section 130 program and continues the option under Section 120 of funding highway-rail crossing safety measures, other than the construction of highway-rail grade separations, utilizing 100-percent federal funding. A total of \$220 million in highway-railroad crossing safety funds is to be apportioned among the states for fiscal years 2006 through 2009. Half of these funds will be apportioned among the states according to the formula for apportionment of STP funding; the other half will be apportioned according to the number of public highway-rail crossings in each state. FHWA has published fact sheets on the new HSIP and the Rail-Highway Crossing provisions.^{17,18}

SAFETEA-LU continues the requirement that a state spend a minimum of 50 percent of its apportionment for the installation of protective devices at railway-highway crossings. The remaining funds may be spent for other types of improvements as defined in Section 130. SAFETEA-LU also contains a provision to use up to 2 percent of the funds apportioned to a state

for compilation and analysis of data for the required annual report to the secretary on the progress being made to implement the railway-highway crossings program. The HSIP also contains a provision that, to further the implementation of a state SHSP, a state may use up to 10 percent of the amount of funds apportioned to the state under Section 104(b)(5) for a fiscal year to carry out safety projects under any other section as provided in the state SHSP, if the state certifies to the secretary that:

- The state has met needs in the state relating to railway-highway crossings; and
- The state has met the state's infrastructure safety needs relating to highway safety improvement projects.

In summary, there are currently three sources of federal funding for construction of highway-rail grade crossing safety improvements:

- The state's normal federal-aid highway funding can be used. This may include Bridge Replacement, National Highway System, or STP funding. Up to 10 percent of the state's apportionment can be designated as G funds, or 100-percent funding, for purposes including some railroad safety projects. See ISTEA 1021(c) and Section 120 of Chapter 23, United States Code.
- Categorical Section 130 funds may be used.
- Funding from other categorical safety programs, such as the Safe Routes to School Program, may be used if such use is consistent with the state's SHSP.

Activities eligible for the use of Section 130 safety funds are as follows:

- Crossing consolidations (including the funding of incentive payments up to \$15,000 on a 50-percent matching basis to local jurisdictions for crossing closures).
- Installation of grade separations at crossings or repair of existing grade separations.
- Signing.
- Pavement marking.
- Illumination.
- New highway-railroad grade crossing signals.
- Upgraded highway-railroad grade crossing signals or circuits.
- Improved crossing surfaces.
- Traffic signal interconnection/preemption.
- Sight distance or geometric improvements.
- Data improvements (up to 2 percent of apportionment).

¹⁷ FHWA Fact Sheets on Highway Provisions (www.fhwa.dot.gov/safetealu/factsheets/hsip.htm).

¹⁸ FHWA Fact Sheets on Highway Provisions (www.fhwa.dot.gov/safetealu/factsheets/railcrossings.htm).

Regular federal-aid highway funds may be used for safety improvements such as the installation of standard signs and pavement markings; the installation or upgrading of active traffic control devices; crossing illumination; crossing approach and surface improvements; new grade separations and the reconstruction of existing grade separations; crossing closures or the removal of existing crossings; and crossing closures by the relocation of highways and/or the relocation of railroads.

Many states have been active in crossing improvement programs for decades. States have been responsible for initiating and implementing projects under the various federal programs. In general, most states once required the railroad or the local government to provide the funds needed to match the federal contribution. However, during the 1930s, some states began to apportion financial responsibility for crossing improvements based on the benefits received by the public (through the highway agency) and the railroad through the project.

California was the first state to establish a state crossing protection fund. In 1953, the Public Utilities Commission was authorized by the legislature to expend or allocate funds from the State Highway User Fund, or any other fund, to assist the cities and counties in paying their allocated portion of the costs for the installation of active traffic control devices at crossings on non-federal-aid highways and streets. In 1957, California established a grade separation fund with an initial apportionment of \$5 million per year. The purpose of the fund was to eliminate existing at-grade crossings by constructing new grade separations or by improving existing grade separations. At least 18 additional states have established separate funding programs for crossing improvements.

States may also utilize other state funds for crossing improvements and to provide the 10-percent match, which is required on some projects funded under the STP safety set-aside program in ISTEA. In addition to financing costs directly associated with the improvement of highway-rail grade crossings, all states contribute incidentally to crossing components. In general, for crossings located on the state highway system, states provide for the construction and maintenance of the roadway approaches and for signs, markings, and other traffic control devices not located on the railroad right of way. Typically, these include advance warning signs and pavement markings. Presently, about 20 states contribute financially toward the maintenance of flashing lights, gates, track circuits, crossing surfaces, and crossbucks. Additional states

have utilized Section 130 or ISTEA funds to pay for projects for the installation of crossbucks at public crossings. More information on state maintenance programs is included in Chapter VII.

Local governments have contributed to highway-rail grade crossing safety improvements by providing the matching funds for improvement projects constructed under Section 130 programs. The passage of ISTEA and the availability of 100-percent federal funding for crossing signalization projects have relieved local jurisdictions of much of the funding burden and have made it possible to construct more improvement projects in smaller jurisdictions. Localities have also contributed for decades through the construction and maintenance of street approaches to crossings and the signs and pavement markings in advance of the crossings. Some cities and counties conduct traffic engineering and safety studies at specific crossing locations.

The railroad industry historically has contributed greatly to the improvement of highway-rail grade crossings. Until the advent of the automobile in the early 1900s, the railroads were considered primarily responsible for safety at crossings. After that, the concept of joint responsibility between the public and the private entity (the railroad) began to emerge. As discussed previously, the federal government and the states began to contribute financially toward crossing improvement projects, thus accepting part of the responsibility that had originally been placed solely on the railroads. The question of who is responsible for what aspect of the crossing program continues to be discussed and refined.

Although public agencies have established funding programs for crossing elimination and improvements, the railroads have continued to contribute as well. In some cases, the railroad may pay all or a part of the required matching share of a project, or the railroad may contribute “in-kind” by way of supplying materials, providing for flagging services, or constructing or signing a detour route during construction of an improvement. Railroads may also contribute through their track and crossing surface maintenance programs or through vegetation or right-of-way clearance programs to improve sight distances at crossings. Some railroads make direct cash contributions to local jurisdictions for crossing consolidations or closures.

At present, costs for maintenance of crossbucks, active traffic control devices, and crossing surfaces are primarily borne by the railroads. Except highway traffic signal gear maintained by local traffic authorities, traffic control devices integrated into

the track structure or the wayside signal system that regulates trains must be maintained by railroad personnel because highly specialized skills are required. Also, rail labor agreements generally specify that union members are to perform this type of work. An industry publication estimated that 1993 costs to the railroads were \$152,566,000 for this type of maintenance work at public crossings.¹⁹ Based on the U.S. Department of Labor Consumer Price Index, this equates to approximately \$206 million in 2005.

C. Responsibilities at Highway-Rail Grade Crossings*

1. Fundamental Issues

An issue as old as the grade crossing safety problem itself is that of responsibility. Who should provide and pay for traffic control devices at highway-rail grade crossings?

During the years between 1850 and 1890, tremendous growth in population followed the railroads west. Consequently, there was a need for new highways and streets, practically all of which crossed the railroads at grade. In most cases, the responsibility for these crossings automatically fell upon the railroads. There were occasional collisions at crossings, but they usually were not as serious as those occurring today.

One early collision, involving the collision of a train and a wagon in Lima, Indiana, resulted in a suit that eventually reached the U.S. Supreme Court in 1877. In *Continental Improvement Co. v. Stead*, the Supreme Court had to decide who was responsible for the damages incurred. In its decision, the Supreme Court said that the duties, rights, and obligations of a railroad company and a traveler on the highway at the public crossing were “mutual and reciprocal.” It also said that the train had the right of way at over crossings because of its “character,” “momentum,” and the “requirements of public travel by means thereof.” The railroad, however, was bound to give reasonable and timely warning of the train’s approach.

The Supreme Court further stated that “those who are crossing a railroad track are bound to exercise ordinary care and diligence to ascertain whether a

train is approaching.” This Supreme Court decision clearly indicated that there was a responsibility upon railroads to warn travelers on highways of approaching trains and a responsibility upon travelers to look, listen, and stop for approaching trains.²⁰

During the late 1890s, the number of crossings and collisions increased. Many states, cities, and towns demanded that the railroads take immediate action to eliminate the hazardous crossings and to provide better traffic control devices. Numerous laws, ordinances, and regulations were enacted or adopted to enforce these demands. There was little uniformity among these laws, ordinances, and regulations; neither was the division of responsibility nor the allocation of costs specified.

In 1893, the Supreme Court, in *New York and N. E. Ry. v. Town of Bristol*, upheld a Connecticut statute that required the railroads to pay three-fourths the costs to improve or eliminate crossings where the highway was in existence before the railroad. If the highway was constructed after the railroad, the state required the railroad to pay one-half such costs. This so-called “Senior-Junior” principle was followed by public utilities commissions and the courts in several states to determine the railroads’ division of responsibility or liability for the construction, improvement, or elimination of crossings. From 1896 to 1935, the Supreme Court adhered to the position that a state could allocate to the railroads all or a portion of the expense or cost for the construction, maintenance, improvement, or elimination of public highway-rail grade crossings.

The crossing safety problem changed greatly with the appearance of motor vehicles on U.S. streets and highways in 1893. As the number of motor vehicles, highway mileage, and railroad trackage increased, so did the number of crossings and crossing collisions. Demands for the elimination of crossings grew stronger nationwide. Because of the dominance and financial status of the railroad industry during this period, the public, state legislative and regulatory bodies, and most of the courts did not hesitate to place the major or entire responsibility for crossing separations and improvements on the railroads. By 1915, the railroads were beginning to feel the impacts of the crossing safety problem and established a national committee to study the problem. During the period from 1915 to 1924, this committee, the National Safety Council, and the American Railway Association engaged in extensive

19 Safetrans System Corporation. “Rail-Highway Grade Crossing Safety: A Continuing Need for Federal Funding,” February 1995.

* Includes previously unpublished materials provided by Ray Lewis, WVDOT, 2006.

20 *Railroad-Highway Safety, Part I: A Comprehensive Statement of the Problem, A Report to Congress*. Washington, DC: U.S. DOT, November 1971.

public education programs to reduce the number of collisions at crossings.

The Depression era of the 1930s brought about abrupt and varying changes in the volumes of rail and highway traffic, which contributed to changes in the responsibility for crossing improvements. A new idea of public responsibility for crossings was enhanced by Congress in its passage of the National Recovery Act of 1933 and the Hayden-Cartwright Act of 1934, which provided funds for the construction of highway-rail grade separations and the installation of crossing traffic control devices.

This expanded federal highway construction program had a great deal of influence on the Supreme Court's landmark decision in *Nashville, C. & St. L. Ry. v. Walters* in 1935. Justice Brandeis, writing for the majority of the Court, said:

*The railroad has ceased to be the prime instrument of danger and the main cause of collisions. It is the railroad which now requires protection from dangers incident to motor transportation.*²¹

In light of that decision, some state legislatures, commissions, and courts revised their division of responsibility criteria and the resulting allocation of costs relating to crossing safety projects.

The Federal-Aid Highway Act of 1944 provided that any railroad involved in any crossing improvement, paid for entirely or in part with federal funds, would be liable to the United States for "a sum bearing the same ratio to the net benefits received by such railway from such project that the Federal funds expended on such project would bear to the total cost of such project." The subsection also provided that the net benefits received by a railway should not "be deemed to have a reasonable value in excess of ten percent of the cost of any such project." The commissioner of public roads was authorized to determine the railroad benefits on the basis of recommendations made by the state highway departments and other information.

During the period from 1944 to 1946, many crossing safety projects were delayed or never started because of prolonged negotiations, arguments, and litigation on the subject of railroad benefits. A compromise was eventually reached whereby each of the crossing improvement projects would be classified in one of five general classes. Depending upon the classification assigned to an individual project, the railroads would

be liable for up to 10 percent of the cost of crossing improvements financed with federal-aid highway funds. FHWA later modified this policy and, presently, the railroads are required to share only up to 5 percent of the costs of certain types of crossing work on federal-aid highway projects.

In the early 1960s, the Interstate Commerce Commission completed an investigation to determine what action should be taken to prevent crossing collisions. In its report and accompanying order, the commission said that:

For practical reasons costs associated with crossing safety improvements should be borne by public funds as users of the crossing plus the fact that it is increasing highway traffic that is the controlling element in accident exposure at these crossings.

The Commission also said that:

In the past it was the railroad's responsibility for the protection of the public at grade crossings. This responsibility has now shifted. Now it is the highway, not the railroad, and the motor vehicle, not the train which creates the hazard and must be primarily responsible for its removal. Railroads were in operation before the problem presented itself and if the increasing seriousness is a result of the increasing development of highways for public use, why should not the cost of grade crossing protection be assessed to the public?

The Commission found that:

*Highway users are the principal recipients of the benefits following from rail-highway grade separations and from special protection at highway-rail grade crossings. For this reason, the cost of installing and maintaining such separations and protective devices is a public responsibility and should be financed with public funds the same as highway traffic devices.*²²

²¹ Ibid.

²² *Prevention of Rail-Highway Grade Crossing Accidents Involving Railway Trains and Motor Vehicles*. Washington, DC: ICC, November 1962.

During the 1970s, the public assumed more responsibility for financing crossing safety improvements. FHWA legislation in 1973 provided categorical safety funds for the elimination or alleviation of hazards at highway-rail grade crossings.²³ These funds were continued in subsequent acts in 1976, 1978, 1980, and 1982. The Surface Transportation Act of 1987 continued the categorical funding and established Section 130 of Title 23 of the United States Code, giving the Federal-Aid Rail-Highway Grade Crossing Safety Program permanent status under the law for the first time.²⁴

ISTEA required that 10 percent of a state's funding under its STP apportionment be set aside for safety improvements and that a proportionate amount of these funds be used for safety improvements at highway-rail grade crossings. ISTEA also made certain types of improvements at railroad grade crossings, including signs, crossing signals, highway lighting (illumination), and pavement markings, eligible for 100-percent federal funding.²⁵

2. Government Agency Responsibility and Involvement

Today, an understanding exists that because a highway-rail crossing involves the intersection of two transportation modes, one public and the other private, its safe and efficient operation requires strict cooperation and coordination of the involved agencies and organizations. Public agencies having oversight and/or program responsibility at the intersection include the following:

At the federal level, six agencies within U.S. DOT and two agencies outside U.S. DOT have specific safety-related roles with respect to highway-rail grade crossings:

- Federal Highway Administration (FHWA).
- Federal Railroad Administration (FRA).
- National Highway Traffic Safety Administration (NHTSA).
- Federal Motor Carrier Safety Administration (FMCSA).
- Federal Transit Administration (FTA).
- Pipeline and Hazardous Materials Safety Administration (PHMSA).
- National Transportation Safety Board (NTSB).
- Surface Transportation Board (STB).

Also at the federal level, NTSB investigates significant transportation collisions and issues findings and recommendations on safety. Finally, although it does not have a direct role in safety, STB has general oversight of the railroads.

At the state level:

- State highway departments.
- State departments of transportation.
- State regulatory agencies (usually called public service commissions or public utility commissions).
- State highway safety agencies.
- State departments of public safety (state police or highway patrol).

At the local level:

- State highway department field maintenance organizations.
- County or township road departments.
- City street departments or public works agencies.
- County or local law enforcement agencies.

Each of these involvements is described below.

U.S. DOT seeks to ensure that a viable and safe national transportation system is maintained to transport people and goods while making efficient use of national resources. Six agencies within U.S. DOT—FHWA, FRA, NHTSA, FTA, FMCSA, and PHMSA—actively participate in crossing safety programs.

FHWA. FHWA administers federally-funded programs, several of which are available for crossing improvements. In addition to the funds specifically set aside by ISTEA for categorical crossing programs, funds from the National Highway System program and the Bridge Replacement program may be utilized at highway-rail crossings. FHWA apportions funds to the states according to legislated formulae and in the amounts authorized by Congress for each program. It establishes procedures by which the states obligate the funds to specific projects and oversees the overall implementation of the federally-funded programs.

FHWA establishes standards for traffic control devices and systems at crossings and publishes them in the *Manual on Uniform Traffic Control Devices*

²³ Highway Safety Act of 1973, Public Law 93-87, 87 Stat. 250.

²⁴ Surface Transportation Assistance Act of 1987, Public Law 100-17, 101 Stat. 171.

²⁵ Intermodal Surface Transportation Efficiency Act of 1991, Public Law 102-240.

(MUTCD).²⁶ FHWA has also adopted various design criteria and guidelines developed by the American Association of State Highway and Transportation Officials and other organizations for use on federal-aid construction and reconstruction projects. It approves state-developed design directives and design criteria for resurfacing, restoration, and rehabilitation projects and other activities. FHWA provides technical assistance to states and local agencies through the distribution of state-of-the-art publications, training classes, and the activities of state Local Technical Assistance Program centers.

FHWA conducts research to support the above activities, and research conducted by the states is often funded using Federal-Aid State Planning and Research funds. Typical research topics include traffic control devices, roadside safety, collision causation, program management tools, and collision countermeasures. All of FHWA's crossing research is coordinated with FRA and, in many cases, FRA contributes financially to the projects. FHWA promotes the maintenance of individual state grade crossing inventories and the updating of the national inventory database.

FRA. FRA maintains the national Railroad Accident/ Incident Reporting System that contains information reported by the railroads on all crossing collisions. FRA also serves as custodian of the National Highway-Rail Crossing Inventory that contains the physical and operating characteristics of each crossing. The information is submitted and updated voluntarily by the railroads and the states. FRA works with other agencies and organizations in overseeing the submission of the inventory data to assure accurate and timely information. FRA also prepares, publishes, and distributes reports summarizing collision and inventory data and makes the data available on the Internet.

FRA conducts field investigations of selected railroad collisions including crossing collisions. FRA investigates complaints by the public pertaining to crossings and makes recommendations to the industry as appropriate.

FRA conducts research to identify solutions to crossing problems, primarily from a railroad perspective. Typical research involves program management tools, train-borne warning devices, car and locomotive reflectorization, and track circuitry improvements. Research is coordinated with FHWA and, in some cases, FHWA contributes financially. Both FHWA and FRA have field offices located

throughout the United States that collaborate with state agencies and the individual railroads, respectively, on a day-to-day basis. They ensure that policies and regulations are effectively implemented and provide feedback to headquarters regarding needs realized at the field level. FHWA has a division office in each state.

FRA also sponsors a considerable amount of research into railroad and crossing safety issues. A significant portion of this research is carried out by the John A. Volpe National Transportation Systems Center in Cambridge, Massachusetts. Other research is performed through the National Cooperative Highway Research Program, administered by the Transportation Research Board.

NHTSA. NHTSA is involved in the crossing program on a limited basis. It maintains the Fatal Accident Reporting System (FARS), a database containing information on all fatal highway collisions. NHTSA coordinates with FRA and FHWA in providing information in FARS that is pertinent to crossings. NHTSA will also fund educational programs and selective law enforcement programs at crossings through state highway safety offices.

FMCSA. FMCSA was established as a separate administration within U.S. DOT on January 1, 2000, pursuant to the Motor Carrier Safety Improvement Act of 1999. The primary mission of FMCSA is to reduce crashes, injuries, and fatalities involving large trucks and buses. FMCSA is committed to increasing grade crossing safety messages to the freight and passenger motor carrier industry as well as to its safety oversight and enforcement partners. FMCSA will try to encourage states to use their Motor Carrier Safety Assistance Program contacts to distribute grade crossing safety materials focused on motor carrier needs and issues at crossings. U.S. DOT also will work with FMCSA to develop informational packages for firms just starting out in the motor carrier industry.

FTA. FTA is one of 10 modal administrations within U.S. DOT. It provides financial assistance to develop new transit systems and improve, maintain, and operate existing systems. Public transit systems include buses, subways, light rail, commuter rail, monorail, passenger ferry boats, trolleys, inclined railways, and people movers. FTA publishes an annual Safety Management Information System report that compiles and analyzes transit safety and security statistics reported through FTA's National Transit Database. Safety data include highway-rail grade crossing collisions.

²⁶ *Manual on Uniform Traffic Control Devices, 2003 Edition.* Washington, DC: FHWA, 2003.

PHMSA. PHMSA was created under the Norman Y. Mineta Research and Special Programs Improvement Act (P.L. 108-426) of 2004. President George W. Bush signed the legislation into law on November 30, 2004. The purpose of the act was to provide U.S. DOT a more focused research organization and establish a separate operating administration for pipeline safety and hazardous materials transportation safety operations. In addition, the act presented U.S. DOT an opportunity to establish model practices in the area of government budget and information practices in support of the President's Management Agenda initiatives.

PHMSA is the federal agency charged with the safe and secure movement of almost 1 million daily shipments of hazardous materials by all modes of transportation. The agency also oversees the U.S. pipeline infrastructure, which accounts for 64 percent of the energy commodities consumed in the United States.

NTSB. NTSB provides a comprehensive review of the safety aspects of all transportation systems. Through special analyses and collision investigations, it identifies specific safety problems and recommends associated remedies that are presented as recommendations to specific agencies and organizations. A set of NTSB recommendations led to the development of overweight/oversize vehicle movement guidelines and pilot car training materials by the Specialized Carriers and Rigging Association, FHWA, and the Commercial Vehicle Safety Alliance.

STB. STB was created in the Interstate Commerce Commission Termination Act of 1995 and is the successor agency to the Interstate Commerce Commission. Congress charged the economic regulatory agency with the fundamental missions of resolving railroad rate and service disputes and reviewing proposed railroad mergers. STB is decisionally independent, although it is administratively affiliated with U.S. DOT.

STB serves as both an adjudicatory and a regulatory body. The agency has jurisdiction over railroad rate and service issues and rail restructuring transactions (mergers, line sales, line construction, and line abandonments); certain trucking company, moving van, and non-contiguous ocean shipping company rate matters; certain inter-city passenger bus company structure, financial, and operational matters; and rates and services of certain pipelines not regulated by the Federal Energy Regulatory Commission. STB staff is divided into the following offices:

- The Office of Compliance and Enforcement monitors rail operations throughout the United

States and enforces regulations over rail and certain non-rail common carriers in the United States. This office also collects and makes available tariffs from non-contiguous domestic water carriers.

- The Office of Congressional and Public Services provides the outreach arm. It works with members of Congress, the public, and the media to answer questions and provide information about STB's procedures and actions and, more generally, about transportation regulation.
- The Office of Economics, Environmental Analysis and Administration houses several functions. In addition to handling administrative matters such as personnel and budget, this office also houses two sections: the Section of Environmental Analysis, which is responsible for undertaking environmental reviews of proposed STB actions in accordance with the National Environmental Policy Act and other environmental laws and making environmental recommendations to the STB, and the Section of Economics, which analyzes rate cases, conducts economic and financial analyses of the railroad industry, and audits Class I railroads.
- The Office of Proceedings researches and prepares draft decisions.
- The Office of General Counsel provides legal advice to STB and defends agency actions that are challenged in court.

State and local level. Jurisdiction over highway-rail grade crossings resides primarily with the states. Within some states, responsibility is assigned to a regulatory agency referred to as a public service commission, a public utilities commission, or similar designation. In other states, the authority is divided among the public administrative agencies of the state, county, or city having jurisdiction over the respective highway and street systems. State highway and transportation agencies are responsible for the implementation of a program that is broad enough to involve any public crossing within the state. Table 6 indicates the state agencies responsible for public and private crossings and whether their jurisdiction is regulatory or administrative.

States are involved in other areas of crossing safety besides jurisdictional responsibility for administering crossings and programs for improvement projects and maintenance. States, along with railroads, are participating in Operation Lifesaver programs, designed to improve safety at crossings and on and around railroad tracks and facilities through

Table 6. State and Local Government Jurisdictional Authorities Concerned with Crossings

State	Agency		Has Authority Relating to				
	Regulatory	Administrative	Public Crossings			Private Crossings	
			Improvement	Cost Allocation	Closing	Improvement	Closing
Alabama	–	S-C-C	Yes	Yes	No	No	No
Alaska	–	Hwy.C	Yes	Yes	Yes	No	No
Arizona	Corp.C	–	Yes	Yes	Yes	No	No
Arkansas	–	S-C-C	Yes	No	Yes	No	No
California	PUG	–	Yes	Yes	Yes	Yes	Yes
Colorado	PUC	S-C-C	Yes	Yes	Yes	No	No
Connecticut	DOT	–	Yes	Yes	Yes	Yes	Yes
Delaware	DOT	DOT	Yes	Yes	Yes	No	No
Florida	DOT	DOT	Yes	Yes	Yes	No	No
Georgia	–	S-C-C	Yes	Yes	Yes	No	No
Hawaii	–	–	–	–	–	–	–
Idaho	PUC	S-C-C	Yes	Yes	Yes	No	No
Illinois	Com.C	–	Yes	Yes	Yes	No	No
Indiana	PSC	S-C-C	Yes	Yes	Yes	No	No
Iowa	DOT	DOT	Yes	Yes	Yes	No	No
Kansas	Corp.C	–	Yes	Yes	No	No	No
Kentucky	–	S-C-C	Yes	Yes	Yes	No	No
Louisiana	–	S-C-C	Yes	No	Yes	No	Yes
Maine	DOT	–	Yes	Yes	Yes	No	No
Maryland	DOT	S-C-C	Yes	Yes	Yes	Yes	Yes
Massachusetts	PUC	–	Yes	Yes	Yes	No	No
Michigan	DOT	–	Yes	Yes	Yes	–	No
Minnesota	DOT	DOT	Yes	Yes	Yes	No	No
Mississippi	PSC	S-C-C	Yes	Yes	Yes	No	No
Missouri	PSC	S-C-C	Yes	Yes	Yes	No	No
Montana	PSC	Hwy.C	Yes	Yes	Yes	No	No
Nebraska	–	S-C-C	Yes	Yes	Yes	No	No
Nevada	PSC	DOT	Yes	Yes	Yes	No	No
New Hampshire	PUC	Hwy.C	Yes	Yes	Yes	Yes	Yes
New Jersey	DOT	DOT	Yes	Yes	Yes	Yes	Yes
New Mexico	Corp.C	–	Yes	Yes	Yes	No	No
New York	DOT	DOT	Yes	Yes	Yes	No	No
North Carolina	–	Hwy-Cty	Yes	Yes	Yes	No	No
North Dakota	PSC	–	Yes	Yes	Yes	Yes	Yes
Ohio	PUG	S-C-C	Yes	Yes	Yes	No	No
Oklahoma	Corp.C	–	Yes	Yes	Yes	No	No
Oregon	PUC	–	Yes	Yes	Yes	No	No
Pennsylvania	PUC	–	Yes	Yes	Yes	No	No
Rhode Island	PUC	DOT	Yes	Yes	Yes	Yes	Yes
South Carolina	–	S-C-C	Yes	Yes	Yes	No	No
South Dakota	DOT	DOT	Yes	Yes	Yes	Yes	Yes
Tennessee	PSC	S-C-C	Yes	Yes	Yes	No	No
Texas	–	S-C-C	Yes	Yes	Yes	No	No
Utah	PSC	DOT	Yes	Yes	Yes	No	No
Vermont	PSC	–	Yes	Yes	Yes	No	No
Virginia	Corp.C	Hwy.C	Yes	Yes	Yes	No	No
Washington	U&TC	–	Yes	Yes	Yes	No	No
West Virginia	PSC	Hwy-Cty	Yes	Yes	Yes	No	No
Wisconsin	TO	–	Yes	Yes	Yes	No	No
Wyoming	PSC	–	Yes	Yes	Yes	No	No

Legend

Com.C	Commerce Commission	PUC	Public Utilities Commission, Division of
Corp.C	Corporation Commission		Public Utilities, Public Utility Commissioner
DOT	Department of Transportation	S-C-C	State, County, City, divided authority
Hwy.C	Highway Commission, Department of Highways	TO	Transportation Commission
Hwy-Cty	Highway Commission and City, divided authority	U&TC	Utilities and Transportation Commission
PSC	Public Service Commission, Public Service Board		

Source: Railroad-Highway Grade Crossing Handbook, Second Edition. Washington, DC: U.S. Department of Transportation, Federal Highway Administration, 1986.

public education regarding the hazards of crossings, the promotion of engineering improvements, and encouraging the enforcement of traffic laws at crossings. Individual state and railroad programs are coordinated at the national level by Operation Lifesaver, Inc., a non-profit corporation. More information on Operation Lifesaver is included in Chapter X, Supporting Programs.

Some states also conduct highway-rail grade crossing research utilizing Highway Planning and Research funds made available through the Highway Trust Fund and the Highway Safety Act of 1973, Public Law 93-87, 87 Stat. 250 of FHWA. Other studies may be performed in house, on a contractual basis, or through universities and are financed through regular state highway funding.

State and local law enforcement agencies are responsible for the enforcement of traffic laws at crossings. Local government bodies are responsible for ordinances governing traffic laws and operational matters relating to crossings.

The historical shifting of responsibility for safety at crossings from the railroads to the public and the increasing availability of federal funds have led to more and more obligations being placed on state and local agencies. This shift culminated with the inclusion of Part VIII, "Traffic Control Systems for Highway-Rail Grade Crossings," in the 1978 edition of MUTCD.²⁷ Part VIII consolidated certain information that had been scattered throughout MUTCD and also superseded the Association of American Railroads (AAR) bulletins covering crossing signalization that had been issued by AAR Committee D. FHWA has also issued regulations specifying criteria for the selection of traffic control devices at highway-rail grade crossings.

The highway agency having jurisdiction at the crossing is the only entity that can legally control traffic. Even though the railroads retain the responsibility for the installation and maintenance of crossbuck signs at "passive" crossings and for the design, construction, operation, and maintenance of railroad crossing signals, state transportation and regulatory agencies have the responsibility to assure that the standards set forth in MUTCD and elsewhere in federal regulations are followed. The street or highway agency is also responsible for the installation and maintenance of all traffic control devices on the approaches to the crossing; for the design, construction, operation, and maintenance of highway traffic signals that may be

interconnected with the grade crossing signals; and for the installation and maintenance of certain passive signs at the crossing, such as STOP signs or "Do Not Stop on Tracks" signs.

FRA has proposed a rule to prohibit railroads from unilaterally selecting the type of grade crossing traffic control systems to be installed at public crossings. The railroads would be required to provide information to the states and to cooperate with them in the selection and design of these systems, but the final responsibility for selection of active devices would be shifted to the public agency.²⁸ At the time of this writing, a final determination regarding the proposed rule had not been made.

Although the railroads retain responsibility for the construction, reconstruction, and maintenance of the track structure and the riding surface at the highway-rail intersection, their obligation for the roadway usually ends within a few inches of the outside ends of the ties that support the rails and the crossing surface. The street or highway agency has responsibility for the design, construction, and maintenance of the roadway approaches to the crossing, even though these approaches may lie within the railroad's right of way.²⁹

3. Railroads

Railroads also work with local governments to alleviate operational and safety concerns at highway-rail grade crossings. For example, switching operations or locations for train crew changes can often be adjusted to avoid blocking crossings or unnecessarily actuating crossing signals. Railroads conduct some research for the purpose of identifying and applying new technology and furthering new concepts regarding crossing safety and operations.

AAR has been active in crossing programs and has established a State-Rail Programs Division within its Operations and Maintenance Department. This division provides information to Congress and U.S. DOT to assist in the administration and establishment of crossing programs. Railroad interests and concerns regarding crossing programs are typically coordinated through the AAR office. The State-Rail Programs Division has appointed a railroad employee in each state to serve as the AAR state representative on crossing safety matters. A list of state representatives is available from AAR.

²⁷ *Manual on Uniform Traffic Control Devices for Streets and Highways, 1978 Edition*. Washington, DC: U.S. DOT, FHWA, 1978.

²⁸ "Selection and Installation of Railroad Grade Crossing Warning Systems." FRA Docket No. RSGC-6; Notice No. 1, Federal Register, March 2, 1995, pp. 11647-11654.

²⁹ *Highway-Rail Crossing Surfaces*. Washington, DC: National Cooperative Highway Research Program Synthesis of Practice 250, 1997.

Other railroad-related companies and suppliers also participate in crossing safety programs. The signal suppliers and manufacturers of crossing surface systems provide guidance for the selection of a specific device or crossing surface. In addition, these companies are actively conducting research to improve their products.

D. Legal Considerations Regarding Highway-Rail Grade Crossings*

1. Background

Highway and railroad engineers and employees are becoming increasingly involved in matters that were previously of interest only to attorneys. Today, it is incumbent upon staffs of state highway departments, local transportation agencies, railroads, and transit operators to become aware and keep abreast of legal issues in general and the legal elements surrounding their design, maintenance, and operational practices in particular.

This discussion of legal considerations in the administration and management of highway-rail grade crossings is a very basic discussion of an increasingly complex subject. It is not meant to interpret the law or to establish guidelines. It is intended only to alert transportation agencies and rail operators to the possible consequences of failure to maintain and safeguard the highway-rail grade crossing. The particular legal aspects of a specific action or legal problem should be discussed with an attorney.

Until recently, government entities were generally immune from lawsuits on the theory of “sovereign immunity” derived from English common law. Under the sovereign immunity doctrine, a government entity can be sued only if it consents to the suit in advance. Over the past 25 to 35 years, this situation has changed dramatically. Sovereign immunity has been eroded through the actions of the courts and legislatures and now survives in some form in less than one-third of the states. Consequently, many state highway agencies have become more vulnerable to lawsuits for damages resulting from collisions, including highway-rail crossing collisions.

Even though many states had some form of sovereign

immunity, this protection frequently did not extend to local government entities and agencies.

Because many states may now be sued for negligence on the part of officers and employees, new emphasis has been placed on the legal responsibility of parties involved in the design of grade crossings and the selection and implementation of crossing safety improvements. This is especially true as state agencies become more responsible for determining which crossings are to be upgraded and determining the type of traffic control devices to be installed.

The state has a duty to correct a dangerous condition when the agency has actual or “constructive” notice of the hazard. The notice requirement does not apply when the condition is the result of the state or agency’s own negligence. For example, a state is not required to have actual notice of faulty construction, maintenance, or repair of its highways because the state is expected to know of its own action, in other words, constructive notice. Constructive notice is knowledge imputed by law, usually after an injury has occurred. However, if the danger did not arise as a consequence of active negligence (such as faulty construction), the agency has a duty to make repairs once it has actual notice of the defect.

Most courts hold that the state or other agency must have had notice of the defect or hazard for a sufficient time “to afford them a reasonable opportunity to repair the condition or take precautions against the danger.” Statutes may require that the agency have notice of the defect for a specified period of time. If, for example, the notice period is five days and the collision was caused by a defect that originated early on the day of the collision, the statutory notice period would not be satisfied and the agency would not have had an opportunity to effect repairs.

On the other hand, the notice may be satisfied where the condition has existed for such a time and is of such a nature that the agency should have discovered the condition by reasonable diligence, particularly where there is no statutorily specified time. In such instance, the notice is said to be constructive, and the agency’s knowledge of the condition is said to be implied.

In deciding whether the agency had notice, the court may consider whether the defect was latent and, thus, difficult to discover. That is, the court will consider the nature of the defect, its location and duration, the extent and use of the highway, and whether the defect could be readily and instantly perceived. Routine inspection and correction procedures are important in light of the trend by courts to allow less and less time before finding constructive notice.

* Includes previously unpublished materials provided by Ray Lewis, WV DOT, 2006.

To understand the legal responsibilities of highway agencies and railroads, it is necessary to understand the basic principles and terminology of tort law.

A tort, in legal terminology, is a civil wrong other than a breach of contract for which a court will provide a remedy in the form of monetary damages. Three basic elements are involved in any tort action:

- A legal duty exists between the parties.
- One of the parties violated or breached that duty.
- Damage occurred to the other party as a result of the breach of duty.

Torts can be either intentional (such as assault and battery, false imprisonment, trespass, or theft) or unintentional (negligence). The primary concern at grade crossings is allegations of negligence.

Liability for a tort means the legal obligation to pay monetary damages to the person who was injured or damaged. More than one person may be liable for damages arising from the same incident. In the case of negligent conduct by an employee, both the employee and the employer may be liable.

Negligence can be defined as the failure to do something that a “reasonable and prudent” person would ordinarily do or the doing of something that a “reasonable and prudent” person would not do. Negligent conduct creates a risk for others to whom are owed a duty of exercising care.

The reasonable person is a criterion used to set the standard of care in judging conduct. In effect, this test of negligence represents the “failure to use ordinary care” and most often is used in determining liability. In the context of this handbook, engineers, railroads, or public agencies may be found negligent if their conduct does not measure up to that of a hypothetical reasonable, prudent, and careful engineer, railroad, or agency under similar circumstances.

Contributory negligence refers to conduct that falls below the standard of care that a person, such as a driver, is legally required to exercise for his own safety, and this failure is a contributing cause to the injury or damage he or she has suffered. Until recently, in most states, a finding of contributory negligence by the court would bar a plaintiff from recovering any damages even if the defendant’s negligence had been established and was the primary cause of the accident. Contributory negligence as a bar to recovery is being gradually eroded in the United States by the doctrine of “comparative negligence.”

Comparative negligence is a rule of law adopted by many states whereby the negligence of all parties is compared, and recovery is permitted despite the contributory negligence of the plaintiff. However, the plaintiff’s damages are usually decreased in proportion to his or her own negligence.

Duty in tort law is an obligation requiring persons to conform to a certain standard of conduct for the protection of others against unreasonable risks. Negligence is a breach of duty to exercise reasonable care owed to those persons to whom the duty applies. In this context, a highway agency owes a duty to all travelers on the highway to avoid creating unnecessary risks for those travelers and to meet the standard of care imposed upon that agency.

The standard of care may be established by a multitude of factors. As a minimum, all persons are required to avoid the creation of unnecessary risks, where feasible. In addition, statutes and regulations governing conduct are also components of the standard of care against which conduct is judged.

Finally and, perhaps most important, the accepted standards and practices of a profession, trade, or industry define the standard of care by which conduct is judged. Included in the definition of “accepted standards and practices” are MUTCD and similar standards.³⁰ The American Railway Engineering and Maintenance-of-Way Association (AREMA) also promulgates recommended practices pertaining to railroads in its *Manual of Railway Engineering* and the *Communication and Signals Manual*. These manuals are not a standard but a compendium of recommended practices to provide railway engineers with guidelines for the construction of railroads.

To place the above concepts in perspective, it is necessary to recognize the following concepts of tort liability:

- Negligence is the failure to exercise reasonable care.
- Court decisions in tort cases are based on the concept of the existence of a “reasonable and prudent” person exercising “ordinary care;” that is, “reasonable care” that would be exercised by a prudent person under the same or similar circumstances.
- The three elements necessary in every tort claim are: (1) existence of a legal duty owed by the defendant to the plaintiff; (2) a breach of that duty; and (3) the occurrence of damage or

³⁰ *Manual on Uniform Traffic Control Devices, 2003 Edition*. Washington, DC: FHWA, 2003.

injury that is the reasonably foreseeable result of that breach of duty.

In effect, this means that the plaintiff (the one bringing the suit) must prove the following if he or she is to win a judgment:

- The defendant (agency or railroad) had a legal duty to use reasonable care toward the plaintiff (the injured party).
- The defendant breached that duty (fell below the standard of care required, thus committing an act of negligence).
- The damages (injuries, property damage, pain and suffering, loss of income, etc.) suffered by the plaintiff were caused by the breach (defendant's negligence) and were the foreseeable result of that breach. That is, but for the negligence of the defendant, the plaintiff would not have suffered damages.
- Finally, depending on whether the particular state follows the contributory or comparative negligence doctrine, the plaintiff, to recover all of the damages suffered, must not have contributed to that negligence (contributory) or must have been less at fault than the agency or railroad (comparative).

To understand the concept of "legal duty," it is necessary to recognize the distinction between discretionary and ministerial (nondiscretionary) acts. Many states that no longer retain their sovereign immunity have enacted Tort Claims Acts, which prescribe the conditions under which the state, its agencies, and its employees may be held accountable. Most of these include a limited exemption from liability for negligence in the performance (or in the nonperformance) of so-called discretionary activities.

The term "discretionary" refers to the power and duty to make an informed choice among alternatives. It requires the consideration of these alternatives and the exercise of independent and professional judgment in arriving at a decision or choosing a course of action. On the other hand, ministerial duties involve clearly defined tasks performed with minimum leeway as to personal judgment and not requiring any evaluation or weighing of alternatives. Consequently, they are nondiscretionary.

In modern law, the distinctions between discretionary and ministerial functions are of great importance in judging tort claims against governmental entities. In general, a public organization or its employees are not liable for negligence in the performance of discretionary activities. However, the courts are

constantly revising the law in these areas, and the classification of a particular governmental activity as either discretionary or ministerial is subject to shifting legal interpretations.

It should be recognized that the limited exemption from liability that has been afforded to discretionary activities in no way provides absolute protection from legal liability. If discretion is abused or exercised recklessly or unjustly, courts may move in and substitute their own discretion for that of the agency.

The courts are fairly uniform in holding that the design of highways is a discretionary function because it involves high-level planning activities and the evaluation of policies, alternatives, and other factors. This is supported by court decisions that hold that design functions are quasi-legislative in character and must be protected from second-guessing by the courts, which are inexpert at making such decisions. Design immunity statutes represent a further effort by legislatures to immunize public employees and bodies from liability arising out of negligence or errors in a plan or design that was duly approved under current standards of reasonable safety.

The courts consider two factors in determining whether a state has taken reasonable care in giving the public adequate warning at a highway-rail grade crossing, summarized as follows:

- In light of the history of accidents and/or level of traffic at the particular crossing, was a collision reasonably foreseeable? If so,
- Was the state reasonable in its choice of traffic control devices to alert the public of the foreseeable risk?

Liability for collisions occurring at grade crossings is governed by the law of negligence. The law imposes the duty to exercise reasonable care to avoid injury to persons using the highway upon public agencies and railroads. Agencies and railroads are under no duty to provide absolute safety.

Potential liability in crossing collisions may create reluctance on the part of states, local agencies, railroads, and suppliers to initiate new technology or procedures that may lead to charges of negligence. Experimentation and in-service trials of new devices are restricted both by potential litigation and by the contractual and insurance requirements and negotiations involved.

The scheduling of improvement projects has become a significant issue in recent court cases involving crossing collisions. The application of administrative rules and procedures to ensure the expeditious

installation of safety improvements based upon the principle of the alleviation of the highest potential hazard is a major factor in these cases.

It should be obvious that it is more logical to expend public funds for sound management practices and proper highway maintenance than for the settlement of claims or the payment of adverse judgments. Consequently, it would seem appropriate to review maintenance activities and reporting procedures to limit exposure to tort liability. It would also seem helpful to assure that all employees involved in such activities are well informed of the legal implications of their functions.

2. Tort Liability and Standards

It has been suggested that railroads and public agencies could significantly reduce tort liability suits involving traffic control devices by implementing four basic steps:

- Know the laws relating to traffic control devices.
- Conduct and maintain an inventory of traffic control devices.
- Replace devices at the end of their effective lives.
- Apply approved traffic control devices according to specifications and standards.

The area of tort law changes rapidly with court decisions (“case law”) and the enactment and amendment of statutes. It is not the purpose of this handbook to serve as a legal reference or to substitute for the knowledge, skills, experience, and judgment of attorneys. Several recent legal issues should be of interest to railroaders and public employees and are expected to have major impacts on tort liability.

Easterwood. The case of *CSX Transportation v. Easterwood* raised the issue of federal preemption. In *Easterwood*, the Supreme Court ruled that train speeds could not be litigated if the speed of the train was within the regulations for the class of track as promulgated by FRA under the Railroad Safety Act of 1970 and that the type of traffic control devices at the crossing could not be litigated if they had been approved by the secretary (of transportation). This generally means that active and/or passive traffic control devices at the crossing should have been selected by a diagnostic team or in accordance with

similar procedures, and that federal funds were used to install or upgrade them.³¹

Shanklin. The case of *Norfolk Southern Railway v. Shanklin* involved an action for damages against a railroad due to its alleged failure to maintain adequate warning devices at a grade crossing in western Tennessee. After her husband was killed in a crossing collision, the respondent brought suit against the petitioner, the operator of the train involved in the collision. The respondent claimed that the warning signs posted at the crossing, which had been installed using federal funds, were insufficient to warn motorists of the danger posed by passing trains. Justice O'Connor delivered the opinion of the Supreme Court in that the Federal Railroad Safety Act of 1970, 84 Stat. 971, as amended, 49 USC §20101 et seq., in conjunction with FHWA's regulation addressing the adequacy of warning devices installed with federal funds, preempts state tort actions such as respondent's.

23 USC §409. The development, operation, and administration of any safety program depends on collection and analysis of data and on the free and unfettered interchange of information between parties. 23 USC §409 was first included in the Surface Transportation Assistance Act of 1987, strengthened by ISTEA, and strengthened again by the National Highway System Designation Act of 1995.³² This section currently reads:

Notwithstanding any other provisions of law, reports, surveys, schedules, lists or data compiled or collected for the purpose of identifying, evaluating or planning the safety enhancement of potential accident sites, hazardous roadway conditions, or railway-highway crossings, pursuant to sections 130, 144 or 152 of this title or for the purpose of developing any highway safety construction improvement project which may be implemented utilizing Federal-aid highway funds shall not be subject to discovery or admitted into evidence in a Federal or State court proceeding or considered for other purposes in any action for damages arising from any occurrence at a location mentioned or addressed in such

31 *CSX Transportation, Inc. v. Easterwood* (1993, US) 123 L. Ed. 2d 387, 113 S Ct 1732, 93 CDOS 2889, 93 Daily Journal DAR 4989, 7 FLW Fed S 172.

32 National Highway System Designation Act of 1995, Public Law 104-59, 109 Stat. 588.

reports, surveys, schedules, lists or data.

Currently, a considerable amount of case law still is being written by the appellate courts concerning the breadth of this restriction. At the time of this writing, the exact scope of the materials that can be excluded is not well defined. It should be noted that this statute may affect the duty of public agencies to release studies and other materials under Freedom of Information Acts.

Design exceptions. All new construction or reconstruction projects should be designed in accordance with accepted standards and criteria, including MUTCD,³³ the latest edition of *A Policy for Geometric Design of Highways and Streets* (the “Green Book”),³⁴ AREMA recommended practices, and state standards and design policies. All efforts should be made to adhere to the specified criteria. However, under unusual conditions, it may be necessary to use values different from or less than the values that have been established. These departures and the reasons for them should be carefully documented, and the documentation should be retained in the permanent project file by both the public entity and the railroad.³⁵

Architects and builders’ statutes. Most state codes include “architect and builders’ statutes,” which bar recovery for deficiencies in planning, design, or construction supervision of improvements to real property after a certain time period has elapsed. These ordinarily are in the form of “statutes of repose” rather than “statutes of limitation.” A statute of limitation ordinarily begins running on the date of an injury; a statute of repose forecloses a cause of action after a stated time period regardless of when an injury occurs. Generally, the statute of repose begins running for design on the date the plans are completed and signed by the engineer or architect; it begins running for construction and construction supervision on the date the work is completed and accepted by the owner. The courts have generally been willing to extend the protections extended by these statutes of repose to construction performed by public agencies and their contractors, including highway improvements.³⁶

33 *Manual on Uniform Traffic Control Devices, 2003 Edition*. Washington, DC: FHWA, 2003.

34 *A Policy on Geometric Design of Highways and Streets, 2004 Edition*. Washington, DC: American Association of State Highway and Transportation Officials, 2004.

35 WVDOT, Roadway Design Division, Design Directive 605, “NHS Design Exception Policy,” April 3, 1995.

36 *Gibson v. W. Va. Department of Highways*; 406 S. E. 2nd 440 (W. Va. 1991).

E. References

Accident/Incident Bulletin. Washington, DC: Federal Railroad Administration (FRA), published annually.

Alternative Solutions to Railroad Impacts on Communities, Final Report. Minnesota Department of Transportation and North Dakota State Highway Department, December 1981.

Amos, Charles L. “Railroad Crossings.” *Better Roads*, Vol. 49, No. 9 (September 1979) and Vol. 49, No. 10 (October 1979).

Annual Report on Highway Safety Improvement Programs. Washington, DC: Federal Highway Administration (FHWA), published annually.

Federal-Aid Policy Guide. Washington, DC: FHWA, updated periodically.

Federal Highway Administration Survey of Region and Division Offices, unpublished, 1984.

Gertler, Judith B. *A Study of State Programs for Rail-Highway Grade Crossing Improvements*. Washington, DC: FRA, Report FRA-OPPD-78-7, June 1978.

Highway Statistics. Washington, DC: FHWA, published annually.

Maintenance Cost Study of Railroad-Highway Grade Crossing Warning Systems. Washington, DC: Association of American Railroads (AAR), October 1982.

Prevention of Rail-Highway Grade Crossing Accidents Involving Railway Trains and Motor Vehicles. Washington, DC: Interstate Commerce Commission, November 1962.

Rail-Highway Crossing Accident Incident and Inventory Bulletin. Washington, DC: FRA, published annually.

Railroad Facts. Washington, DC: AAR, September 1983 and October 1984.

Railroad-Highway Safety, Part I: A Comprehensive Statement of the Problem, A Report to Congress. Washington, DC: U.S. Department of Transportation (U.S. DOT), November 1971.

Railroad-Highway Safety, Part II: Recommendations for Resolving the Problem, A Report to Congress. Washington, DC: U.S. DOT, August 1972.

Report on the Unit Coal Train Community Impact Conference. Washington, DC: U.S. DOT, August 1979.

Schercinger, John M. *1984 Grade Crossing Statistics Show Continued Safety Improvement.* Washington, DC: AAR, September 1984.

Schoppert, David W. and Dan W. Hoyt. *Factors Influencing Safety at Highway-Rail Grade Crossings.* Washington, DC: Highway Research Board, National Cooperative Highway Research Program Report 50, 1968.

Traffic Control Devices Handbook. Washington, DC: Institute of Transportation Engineers, 2001.

Components of a Highway-Rail Grade Crossing



A highway-rail grade crossing can be viewed as simply a special type of highway intersection, in that the three basic elements of any intersection are present: the driver, the vehicles, and the physical intersection. As with a highway intersection, drivers must appropriately yield the right of way to opposing traffic; unlike a highway-highway intersection, the opposing traffic—the train—must only rarely yield the right of way to the highway vehicle. Drivers of motor vehicles have the flexibility of altering their path of travel and can alter their speed within a short distance. Train operators, on the other hand, are restricted to moving their trains down a fixed path, and changes in speed can be accomplished much more slowly. Because of this, motorists bear most of the responsibility for avoiding collisions with trains.

The railroad crossbuck sign is defined in the *Manual on Uniform Traffic Control Devices* (MUTCD) as a regulatory sign.³⁷ In effect, it is a YIELD sign, and motorists have the obligation to so interpret it. (Refer to the discussion on the use of STOP and YIELD signs in Chapter IV.) Traffic and highway engineers can assist motorists with the driving task by providing them with proper highway design, adequate sight distances, and proper traffic control devices.

The components of a highway-rail grade crossing are divided into two categories: the highway and the railroad. The highway component can be further classified into several elements including the roadway, drivers, pedestrians and bicyclists, and vehicles. The railroad component is classified into train and track elements. The location where these two components meet must be designed to incorporate the basic needs of both highway vehicles and trains.

Traffic control devices are utilized to provide road users with information concerning the crossing. Typically, an advance warning sign and pavement markings inform the motorist that a crossing lies ahead in the travel path. The crossing itself is identified and located by the use of the crossbuck. These traffic control devices—the advance sign, pavement markings, and crossbuck—are termed “passive” because their message remains constant with time.

“Active” traffic control devices tell the motorist whether or not a train is approaching or occupying a crossing and, thus, give a variable message. Typical active traffic control devices are flashers or flashers and automatic gates. A highway traffic signal may also be interconnected to the crossing signals and would form part of the traffic control system at the crossing.

The U.S. Department of Transportation (U.S. DOT) National Highway-Rail Crossing Inventory provides information on the number of crossings having each type of traffic control device, as shown in Table 7.

A. The Highway Component*

1. Driver

The driver is responsible for obeying traffic control devices, traffic laws, and the rules of the road. Highway and railroad engineers who plan and design initial installations or later improvements to traffic control systems at railroad grade crossings should be aware of the several capabilities, requirements, needs, and obligations of the driver. This information will help them, through the proper engineering design of improvements, assist drivers in meeting their responsibilities.

* Includes previously unpublished materials provided by Ray Lewis, West Virginia Department of Transportation (WVDOT), 2006.

³⁷ *Manual on Uniform Traffic Control Devices, 2003 Edition*. Washington, DC: Federal Highway Administration (FHWA), 2003.

Table 7. Public Crossings by Warning Device, 2004

Warning device	Number	Percent
Active devices		
Gates	36,760	24.87
Flashing lights	25,081	16.97
Highway signals, wigwags, or bells	1,217	0.82
Special*	2,912	1.97
Total active	65,970	44.63
Passive devices		
Crossbucks	66,463	44.97
STOP signs	10,189	6.89
Other signs	687	0.47
Total passive	77,339	52.33
No signs or signals	4,496	3.04
Total	147,805	100.00

* Note: “Special” are traffic control systems that are not train activated, such as a crossing being flagged by a member of the train crew.

Source: Unpublished data from Federal Railroad Administration.

Much of the information regarding driver characteristics and capabilities is covered in Chapter III and need not be stated here. This section deals with the duties of the motor vehicle driver.

The Uniform Vehicle Code (UVC) is a specimen set of motor vehicle laws designed or advanced as a comprehensive guide or standard for state motor vehicle and traffic laws.³⁸ It describes the actions a driver is required to take at highway-rail grade crossings. The UVC defines the “appropriate actions” vehicle operators are required to take for three situations: vehicle speed approaching the crossing; vehicle speed traversing the crossing; and stopping requirements at the crossing. The provisions in UVC for these actions are set out below:

³⁸ *Uniform Vehicle Code and Model Traffic Ordinance*. National Committee on Uniform Traffic Laws and Ordinances, Evanston, Illinois, revised 2005 (www.ncutlo.org/modellaws.htm).

- *Approach Speed (Sec. 11-801)*

No person shall drive a vehicle at a speed greater than is reasonable and prudent under the conditions and having regard to the actual and potential hazards then existing. Consistent with the foregoing, every person shall drive at a safe and appropriate speed when approaching and crossing an intersection and railroad grade crossing . . .

- *Passing (Sec. 11-306)*

(a) No vehicle shall be driven on the left side of the roadway under the following conditions ...

... When approaching within 100 feet of or traversing any intersection or railroad grade crossings unless otherwise indicated by official traffic control devices . . .

- *Vehicles Approaching a Highway-Rail Grade Crossing (Sec. 11-702)*

(a) Whenever a road user approaches a highway-rail grade crossing under any of the five circumstances enumerated in this subsection, the driver shall stop before the stop line (if present) and not less than 15 feet from the nearest rail of the track, and while so stopped shall listen and look in both directions along such track for signals indicating the approach of a train or other vehicle, and shall not proceed until it is safe to do so. The foregoing requirements shall apply when any of the following occur:

- *An approaching train is visible and in hazardous proximity to such crossing.*
- *A clearly visible electric or mechanical signal device gives warning of the immediate approach of a railroad train;*
- *A stop sign or other traffic control device requiring a stop is posted at the crossing;*
- *A crossing gate is lowered or is being lowered or raised, or a human flagger gives or continues to give a signal of the approach or passage of a railroad train; or*
- *An approaching train horn is being sounded.*

(b) Except for the five instances requiring a stop listed in subsection (a) or unless otherwise specified by law, regulation or the directions of a police officer, flagger or a traffic control device, a person driving a vehicle approaching a highway-rail grade crossing shall yield the right of way to any train within the crossing or approaching so closely as to constitute an immediate hazard during the time such driver is moving across or within the crossing. After stopping or yielding as required herein and proceeding when it is safe to do so, the driver shall cross only in a gear of the vehicle that will not require manually changing gears while traversing such crossing and the driver shall not manually shift gears while crossing the track or tracks.

- *Designated Vehicles Must Stop at Highway-Rail Grade Crossings (11-703)*

(a) Except as provided in subsection (b), the driver of any vehicle described in regulations issued pursuant to subsection (c), before crossing at grade any track or tracks of a railroad, shall stop such vehicle before the stop line (if present) and not less than 15 feet from the nearest rail of such track, and while so stopped shall listen and look in both directions along such track for any approaching train and for signals indicating the approach of a train and shall not proceed until it is safe to do so. After stopping as required, upon proceeding when it is safe to do so, the driver shall cross only in a gear of the vehicle that will not require manually changing gears while traversing such crossing and the driver shall not manually shift gears while crossing the track or tracks.

(b) This section shall not apply at any highway-rail grade crossing:

- 1. Controlled by a police officer or flagger;*
- 2. At which an official traffic control device provides notice that the stopping requirement imposed by this section shall not apply;*
- 3. A streetcar crossing, or railroad tracks used exclusively for industrial switching purposes, within a business district;*

- 4. An abandoned railroad grade crossing which is marked with a sign indicating that the rail line is abandoned;*
- 5. An industrial or spur line railroad grade crossing marked with a sign reading "Exempt." Such "Exempt" signs shall be erected only by or with the consent of the appropriate State or local authority.*

(c) The (commissioner or other appropriate State official or agency) shall adopt regulations, as may be necessary, describing the vehicles that must comply with the stopping requirements of this section. In formulating those regulations, the (commissioner or other appropriate State official or agency) shall consider the operating characteristics of the vehicle, the number of passengers carried, and the hazardous nature of any substance carried in determining whether such vehicle shall be required to stop.

The UVC also prohibits any vehicle from driving around or under any gate or barrier while it is closed or being opened or closed.

Each state has its own traffic laws, which may vary from those above. The pertinent sections of the state code and the state driver licensing handbook should be consulted for more information.

2. Vehicle

The design and operation of a railroad grade crossing must take into account the numbers and types of vehicles that can be expected to use it. In this regard, crossings are exposed to the full array of vehicle types found on highways, from motorcycles to truck tractor/triple-trailer combinations, although the use of crossings by the largest vehicle types is rare. Typically, the largest vehicles that will use an at-grade crossing are full-size passenger buses or design trucks such as WB-50. The vehicles utilizing highway-rail grade crossings have widely different characteristics that will directly influence the design elements of the crossing. Equally important is the cargo these vehicles carry, especially children in school buses and hazardous materials in trucks.

Table 8 summarizes collisions at crossings by vehicle type. Rates are defined as collisions per billion miles of travel. The data provide some indication of the relative hazards for each of the vehicles. Trucks have the highest collision rates of all vehicle types. Motorcycles

Table 8. Motor Vehicle Collisions and Casualties at Public Crossings by Vehicle Type, 2004

	Automobiles ¹	Buses	Trucks ²	Motorcycles	Total
Total collisions					
Number	1,828	7	587	9	2,431
Rate ³	0.67	1.05	2.59	0.90	0.84
Percent	75.19	0.29	24.15	0.37	100.00
Total fatalities					
Number	204	0	35	2	241
Rate ³	0.08	0.00	0.15	0.20	0.08
Percent	84.65	0.00	14.52	0.83	100.00
Total injuries					
Number	648	7	225	5	885
Rate ³	0.24	1.05	0.99	0.50	0.31
Percent	73.22	0.79	25.42	0.57	100.00
Vehicle miles of travel (billions)	2,719.32	6.64	226.51	10.05	2,890.89
Registered vehicles	228,276,000	795,000	8,171,000	5,781,000	236,761,000
Collisions per million vehicles	8.01	8.81	71.84	1.56	10.27

¹ “Automobiles” includes passenger cars, pick-up trucks, vans, and sport utility vehicles.

² “Trucks” includes both single-unit trucks and combination trucks.

³ “Rate” is the number of collisions, fatalities, or injuries divided by billions of vehicle miles traveled.

Source: Railroad Safety Statistics Annual Report 2004. Bureau of Transportation Statistics Website (www.bts.gov).

have a higher fatality rate, probably because of the lack of operator protection provided by the vehicle.

Several physical and performance characteristics influence the safety of vehicles at crossings. These include vehicle dimensions, braking performance, and acceleration performance.

Vehicle dimensions. The length of a vehicle has a direct bearing on the inherent safety of the vehicle at a grade crossing and, consequently, is an explicit factor considered in the provision of sight distances. Long vehicles and vehicles carrying heavy loads have longer braking distances and slower acceleration capabilities; hence, long vehicles may be exposed to a crossing for an even greater length of time than would be expected in proportion to their length.

Vehicle length is explicitly considered in determining the effect of sight distance and the corner sight triangle on the safe vehicle approach speed toward the crossing and in determining the sight distance along the track for vehicles stopped at the crossing. The design lengths of various vehicles are specified by the American

Association of State Highway and Transportation Officials (AASHTO) and shown in Tables 9 and 10.

AASHTO now recognizes a total of 20 design vehicle classes. This reflects the increase in the size of tractor-semitrailers, which began with the passage of the Surface Transportation Assistance Act of 1982, as well as the increasing presence of articulated buses in the U.S. transit fleet and the increasing popularity of recreational vehicles and motor homes.³⁹

Unless trucks are prohibited at the crossing, it is desirable that the design vehicle be at least a tractor-semitrailer truck (WB-15 SI Metric, or WB-50). Typically, the design vehicle should be a “double-bottom” vehicle (WB-18 SI Metric, or WB-60) for those crossings on routes designated for longer trucks, although consideration should be given especially to long vehicles where applicable. On major arterials with significant truck traffic, the design vehicle should be an “interstate” semitrailer truck (WB-62 or WB-65).

³⁹ *A Policy on Geometric Design of Highways and Streets, 2004 Edition*. Washington, DC: American Association of State Highway and Transportation Officials (AASHTO), 2004.

Table 9. U.S. Customary Lengths for Design Vehicles

Design vehicle type	Designation	Length (feet)
Passenger car	P	19
Single-unit truck	SU	30
Buses		
Intercity bus (motor coaches)	BUS-40	40
	BUS-45	45
City transit bus	CITY-BUS	40
Conventional school bus (65 passengers)	S-BUS 36	35.8
Large school bus (84 passengers)	S-BUS 40	40
Articulated bus	A-BUS	60
Trucks		
Intermediate semitrailer	WB-40	45.5
Intermediate semitrailer	WB-50	55
Interstate semitrailer	WB-62*	68.5
Interstate semitrailer	WB-65** or WB-67	73.5
“Double-bottom” semitrailer/trailer	WB-67D	73.3
Triple-semitrailer/trailers	WB-100T	104.8
Turnpike double-semitrailer/trailer	WB-109D*	114
Recreational vehicles		
Motor home	MH	30
Car and camper trailer	P/T	48.7
Car and boat trailer	P/B	42
Motor home and boat trailer	MH/B	53
Farm tractor***	TR	16

* Design vehicle with 48-foot trailer as adopted in the 1982 Surface Transportation Assistance Act.

** Design vehicle with 53-foot trailer as adopted grandfathered in with the 1982 Surface Transportation Assistance Act.

*** 150–200 horsepower tractor excluding any wagon length.

Source: From A Policy on Geometric Design of Highway and Streets, 2004, by the American Association of State Highway and Transportation Officials, Washington, DC. Used by permission.

The width of the vehicle may be an issue when selecting the crossing surface. Since the passage of the 1982 Surface Transportation Assistance Act, trucks and intercity buses are permitted to have widths of 2.6 meters (102 inches).

Braking performance. One component of stopping sight distance is a function of a vehicle’s braking performance. If a crossing experiences a significant percentage of heavy trucks, any given sight distance will dictate a slower speed of operation to allow for the braking performance of these vehicles.

Acceleration performance. Acceleration of vehicles is important to enable a stopped vehicle to accelerate and clear the crossing before a train that was just out of sight or just beyond the train detection circuitry reaches the crossing. Large trucks that have relatively poor acceleration capabilities coupled with long lengths are particularly critical in this type of situation.

There are three phases of operation for a truck that has stopped at a crossing: start-up when the clutch is being engaged; acceleration from the point of full clutch engagement; and continued travel until the crossing is cleared.

Another aspect of the acceleration performance of vehicles at crossings is the design of the crossing approaches coupled with the condition of the crossing surface. Crossings and approaches on a steep grade are difficult and time-consuming to cross. Also, vehicles will move more slowly over crossings that have rough surfaces.

Special vehicles. Three vehicle types are of particular concern for crossing safety: trucks carrying hazardous materials; any commercial motor vehicle transporting passengers; and school buses. Collisions

Table 10. Metric Lengths for Design Vehicles

Design vehicle type	Designation	Length (meters)
Passenger car	P	5.8
Single-unit truck	SU	9.2
Buses		
Intercity bus (motor coaches)	BUS-12	12.2
	BUS-14	13.7
City transit bus	CITY-BUS	12.2
Conventional school bus (65 passengers)	S-BUS 11	10.9
Large school bus (84 passengers)	S-BUS 12	12.2
Articulated bus	A-BUS	18.3
Trucks		
Intermediate semitrailer	WB-12	13.9
Intermediate semitrailer	WB-15	16.8
Interstate semitrailer	WB-19*	20.9
Interstate semitrailer	WB-20**	22.4
“Double-bottom” semitrailer/trailer	WB-20D	22.4
Triple-semitrailer/trailers	WB-30T	32.0
Turnpike double-semitrailer/trailer	WB-33D	34.8
Recreational vehicles		
Motor home	MH	9.2
Car and camper trailer	P/T	14.8
Car and boat trailer	P/B	12.8
Motor home and boat trailer	MH/B	16.2
Farm tractor***	TR	4.9

* Design vehicle with 14.63-meter trailer as adopted in the 1982 Surface Transportation Assistance Act.

** Design vehicle with 16.16-meter trailer as adopted grandfathered in with the 1982 Surface Transportation Assistance Act.

*** 150-200 horsepower tractor excluding any wagon length.

Source: From A Policy on Geometric Design of Highway and Streets, 2004, by the American Association of State Highway and Transportation Officials, Washington, DC. Used by permission.

involving these vehicles can result in numerous injuries and/or fatalities, perhaps in catastrophic proportions if certain hazardous cargoes are involved.

In a special study conducted by the National Transportation Safety Board (NTSB), it was determined that an average of 62 collisions involving train collisions with trucks transporting hazardous materials occur annually. NTSB’s examination of the collision data revealed that these collisions tend to occur near truck terminals.⁴⁰

Requirements for commercial vehicles to stop or slow at highway-rail grade crossings are contained in 49 CFR Part 392.10, which requires that the driver of a specified commercial motor vehicle:

Shall not cross a railroad track or tracks at grade unless he/she first: Stops the commercial motor vehicle within 50 feet of, and not closer than 15 feet to, the tracks; thereafter listens and looks in each direction along the tracks for an approaching train; and ascertains that no train is approaching. When it is safe to do so, the driver may drive the commercial motor vehicle across the tracks in a gear that permits the commercial motor vehicle to complete the crossing without a change of gears. The driver must not shift gears while crossing the tracks.

Vehicles to which this rule pertains include but are not limited to:

- Every bus transporting passengers and vehicles transporting migrant workers. (“Bus”

⁴⁰ Railroad/Highway Grade Crossing Accidents Involving Trucks Transporting Bulk Hazardous Materials, A Special Study. Washington, DC: National Transportation Safety Board, Report NTSB-HZM-81-2, September 1981.

is defined at 49 CFR 390.5 as “as any motor vehicle designed, constructed, and or used for the transportation of passengers, including taxicabs.”)

- Every commercial motor vehicle which, in accordance with the regulations of U.S. DOT, is required to be marked or placarded with hazardous materials including:
 - Poison Gas.
 - Flammables.
 - Chlorine.
 - Poison.
 - Oxygen.
 - Combustible liquids.

Exceptions provided in the rule indicate a stop need not be made at:

- A streetcar crossing, or railroad tracks used exclusively for industrial switching purposes, within a business district;
- A railroad grade crossing when a police officer or crossing flagman directs traffic to proceed;
- A railroad grade crossing controlled by a functioning highway traffic signal transmitting a green indication which, under local law, permits the commercial motor vehicle to proceed across the railroad tracks without slowing or stopping;
- An abandoned railroad grade crossing marked with a sign indicating that the rail line is abandoned; or
- An industrial or spur line railroad grade crossing marked with a sign reading “Exempt.” Such signs shall be erected only by or with the consent of the appropriate state or local authority.

As required by §398.4, all such motor vehicles shall display a sign on the rear reading, “This Vehicle Stops at Railroad Crossings.”

Finally, Part 392.11 provides that:

Every commercial motor vehicle other than those listed in §392.10 shall, upon approaching a railroad grade crossing, be driven at a rate of speed which will permit said commercial motor vehicle to be stopped before reaching the nearest rail of such crossing and shall not be driven upon or over such crossing until due caution has been taken to ascertain that the course is clear.

Provisions to enhance safety for these special vehicles are further discussed in Chapter IX, Special Issues.

3. Pedestrians

In 2004, collisions involving pedestrians at crossings accounted for only 3.6 percent, or 111, of all crossing collisions. As can be expected, these collisions almost always result in an injury or fatality. In 2004, there were 73 pedestrian fatalities, comprising 6.8 percent of all crossing fatalities. These statistics do not include pedestrian collisions occurring elsewhere along railroad tracks. Excluding collisions and incidents at crossings, 482 trespasser fatalities occurred on railroad property during 2004. This represents 54 percent of all railroad-related fatalities.

Table 11 shows the number of highway-rail grade crossing collision fatalities and trespasser fatalities from 1995 to 2004. During this 10-year period, crossing collision fatalities steadily decreased while trespasser fatalities remained generally constant. Each year since 1997, the number of trespasser fatalities has been greater than the number of highway-rail grade crossing collision fatalities.

Table 11. Highway-Rail Grade Crossing Collision Fatalities versus Trespasser Fatalities, 1995–2004

Year	Highway-rail grade crossing collision fatalities	Trespasser fatalities
1995	579	494
1996	488	471
1997	461	533
1998	431	536
1999	402	479
2000	425	463
2001	421	511
2002	357	540
2003	334	500
2004	368	482

Source: Federal Railroad Administration Safety Data Website (safetydata.fra.dot.gov/officeofsafety).

One difference between the driver and a pedestrian at a grade crossing is the relative ease with which a pedestrian can enter the trackway even if pedestrian gates are provided.

It is important to understand four contributing factors that may motivate pedestrians to enter railroad right of way to establish effective preventive measures. First, as a consequence of urban development, railroads often act as physical dividers between important, interrelated elements of communities.

Second, railroads have always attracted juveniles as “play areas.” Third, at or near commuter stations, passengers frequently use short cuts before or after boarding a train. Fourth, some people are prone to vandalism.⁴¹

Several types of preventive measures might be employed, including:

- Fencing or other devices for enclosing rights of way.
- Grade separation.
- Additional signing.
- Safety education.
- Surveillance and enforcement.

These measures are discussed in more detail in Chapter IX, Special Issues.

There is renewed interest in pedestrian treatments. Light-rail operators have been deploying various devices to address pedestrian concerns (refer to Chapter IX.) The National Committee on Uniform Traffic Control Devices (NCUTCD), at its January 2006 meeting, established a Pedestrian Task Force on the Railroad Technical Committee, which is charged with developing language that will provide guidance and options for a wider array of pedestrian treatments at grade crossings.

4. Roadway

A major component of the crossing consists of the physical aspects of the highway on the approach and at the crossing itself. The following roadway characteristics are relevant to the design and control of highway-rail grade crossings:

- Location—urban or rural.
- Type of road—arterial, collector, or local.
- Traffic volumes.
- Geometric features—number of lanes, horizontal and vertical alignment, sight distance, crossing angle, etc.
- Crossing surface and elevation.
- Nearby intersecting highways.
- Illumination.

Urban crossings often carry more vehicular traffic than rural crossings and have sight restrictions due to developed areas. Urban crossings also involve obstructions to continuous traffic flow, such

as controlled intersections, driveways, business establishments and distracting signs, significant lane interaction, and on-street parking.

All other factors being the same, especially train volumes, collision frequency increases with increasing traffic volume. However, traffic volume alone is not a sufficient forecaster of collisions at crossings. This will be shown when collision prediction models are discussed in Chapter III, Assessment of Safety and Operations.

The geometric features that can affect traffic operations at highway-rail grade crossings include:

- Number of lanes and pavement width.
- Horizontal and vertical alignment.
- Crossing angle.
- Crossing elevation.

These features, in turn, affect sight distances to and at crossings.

Number of lanes. Only 7 percent of all public crossings are on highways with more than two lanes.⁴² It is not known how many crossings with two lanes have an approach width greater than two lanes. The reduction of lanes at a crossing can cause vehicle-vehicle collisions as well as collisions with trains.

At two-lane crossings, a pullout lane may be provided for trucks or buses that may be required to stop for the crossing. By providing a pullout lane, the likelihood of rear-end collisions may be reduced.

Crossings with more than two lanes are usually candidates for cantilevered flashing light signals to improve the visibility of the signals for drivers.

Vertical and horizontal alignment. Sight distance to the crossing is affected by the vertical and horizontal alignment of the crossing and by the crossing angle. Crossings located around a curve or over the crest of a hill may require special attention from the motorist and may need additional signing or active advance warning devices.

Crossing and approach surfaces. The roughness of a crossing surface and the profile of the surface and its approaches may be major areas of concern for road users. A rough surface may contribute to a collision by diverting the road user’s attention from the prime tasks of observing the crossing signals and looking for a train.

41 Texas Transportation Institute. “Participant Notebook for a Training Course in Railroad-Highway Grade Crossing Improvement Programs.” Prepared for FHWA, College Station, Texas, revised November 1979.

42 *Highway Rail Crossing Accident/Incident and Inventory Bulletin (No. 18 Calendar Year 1995)*. Washington, DC: U.S. Department of Transportation (U.S. DOT), Federal Railroad Administration (FRA), September 1996.

Crossing elevation or profile. Another aspect of the crossing is its elevation. Vehicles that must cross the tracks from a stopped position cannot accelerate quickly on steep grades. In addition, trucks with low ground clearances may become trapped on high-profile or “hump-backed” crossings, delaying highway and rail traffic and, possibly, being struck by a train.

Intersecting highways. Approximately one-third of all public highway-rail crossings have a highway intersection within 23 meters (75 feet) of the tracks. Frequently, roads parallel the railroad and intersecting roads intersect the railroad, resulting in a crossing near the highway intersection.

The higher occurrence of collisions at these intersections is due in part to a short storage area for vehicles waiting to move through the crossing and the intersection. If the intersection is signalized or if the approach from the crossing is controlled by a STOP sign, queues may develop across the crossing, leading to the possibility of a vehicle becoming “trapped” on the crossing. Also, there are more distractions to the motorist, leading to the possibility of vehicle-vehicle conflicts.

Crossings within a close distance to a signalized or STOP-controlled intersection should be carefully evaluated for proper controls. STOP controls should be evaluated where either the crossing or the intersection, or both, is not signalized. Traffic signal timing should be carefully evaluated, and an interconnection circuit installed if needed. Joint inspections of interconnected or preempted signals by the railroad and the highway agency must be made on a regular basis to assure that the crossing signals and the highway traffic signal are functioning properly and that the phasing and timing plans are still appropriate.

The critical distance between a highway-rail crossing and a highway-highway intersection is a function of the number of vehicles expected to be queued up by the intersection traffic control.

Illumination. Illumination of the crossing can definitely aid the motorist. In 2004, 1,214 of 3,063 total collisions at crossings occurred during darkness.⁴³ Illumination may be effective in reducing collisions at night; it will also assist road users, including bicyclists and pedestrians, in traversing the crossing at night. U.S. DOT inventory reports that commercial power is available at more than 90 percent of public crossings. Therefore, lighting is feasible at most crossings;

depending, of course, on the reliability of the power source. Design details of illumination are discussed in Chapter IV, Identification of Alternatives.

5. Traffic Control Devices

Traffic control systems for highway-rail grade crossings include all signs, signals, markings, and illumination devices and their supports along highways approaching and at railroad crossings at grade. The function of these devices is to permit safe and efficient operation of highway and rail traffic over crossings.

The responsibility for the design, placement, operation, and maintenance of traffic control devices normally rests with the governmental body having jurisdiction over the road or street. For the purpose of installation, operation, and maintenance of devices constituting traffic control devices at highway-rail grade crossings, it is recognized that any crossing of a public road with a railroad is situated on right of way that is available for the use of both highway traffic and railroad traffic on their respective roadway and tracks. This requires joint responsibility in the traffic control function between the public agency and the railroad.

The determination of need and the selection of devices at a grade crossing are normally made by the public agency having jurisdiction. Subject to such determination, the design, installation, and operation of such devices shall be in accordance with the principles and requirements set forth in MUTCD.⁴⁴

Due to the character of operations and the potentially severe consequences of collisions, traffic control devices at highway-rail grade crossings and on the approaches thereto must be viewed as a system. The combination of approach signs and pavement markings on the roadway approach and the crossbucks or signals at the crossing provides the road user with multiple notices of the presence of the crossing and the likelihood of encountering a train.

For those sections where rail tracks run within a roadway, which is a common practice for light rail and streetcar operations, traffic control may be provided by a combination of signs, pavement markings, and typical “highway” type control devices such as STOP signs and traffic signals. However, for the broader case, where rail tracks are located in a separate right of way with designated crossings of highways and pedestrian pathways, traffic is typically controlled with one of three types of devices, each requiring a distinct

⁴³ *Railroad Safety Statistics 2004 Annual Report*. Washington, DC: U.S. DOT, FRA, November 2005.

⁴⁴ *Manual on Uniform Traffic Control Devices, 2003 Edition*. Washington, DC: FHWA, 2003.

compliance response per the UVC, various Model Traffic Ordinances and state regulations:

- A crossbuck is a type of YIELD sign: The driver should be prepared to stop at least 4.5 meters (15 feet) before the near rail if necessary, unless and until the driver can make a reasonable decision that there are no trains in hazardous proximity to the crossing and it is safe to cross.
- Operating flashing lights have the same function as a STOP sign: A vehicle is required to stop completely at least 4.5 meters (15 feet) short of the near rail. Then, even though the flashing lights may still be operating, the driver is allowed to proceed after stopping (subject to state or local laws), when safe to do so.
- Flashing lights with lowered gates are equivalent to a red vehicular traffic signal indication: A vehicle is required to stop short of the gate and remain stopped until the gates go up.

Motorist comprehension and compliance with each of these devices is mainly a function of education and enforcement. The traffic engineer should make full use of the various traffic control devices as prescribed in MUTCD to convey a clear, concise, and easily understood message to the driver that should facilitate education and enforcement.⁴⁵

B. Railroad Components

A railroad's class is determined by its inflation-adjusted operating revenues for three consecutive years, using the following scale (2004 amounts):

- Class I: \$250 million or more.
- Class II: less than \$250 million but more than \$20 million.
- Class III: \$20 million or less.

Using the inflation-adjusted index, the year 2005 threshold for a Class I railroad is \$289.4 million. In 2005, there were seven U.S. Class I railroads:

- BNSF Railway.
- CSX Transportation.
- Grand Trunk Corporation.
- Kansas City Southern Railway.
- Norfolk Southern Combined Railroad Subsidiaries.

- Soo Line Railroad.
- Union Pacific Railroad.

Two Canadian railroads, Canadian National Railway and Canadian Pacific Railway, have enough revenue that they would be U.S. Class I railroads if they were U.S. companies. Both companies also own railroads in the United States that, by themselves, qualify to be Class I railroads.

In 2004, there were some 21 Class II railroads.

In 2004, there were about 525 Class III line-haul railroads and switching and terminal companies, also Class III. Many of these Class III railroads provide switching and terminal services for the larger Class I and II railroad companies. Some Class III railroads take over the operation of a single line that a larger railroad abandoned for economic reasons. Class III railroads often require assistance with regard to highway-rail grade crossings because of their limited manpower and financial resources. These small railroads are often unable to seek out federal and state funds for improving crossings, but safety at their crossings is just as important as at any other crossing.

For the purposes of this handbook, the railroad components of highway-rail grade crossings have been divided into two categories: train and track.

1. Train

During every business day, approximately 112,000 freight cars are loaded in the United States, Canada, and Mexico.⁴⁶ Statistics as to the average length, net lading, and overall speed of freight trains in a typical year do not begin to describe the variety of operations involved in railroad freight movements. Unit trains may cover more than 1,500 miles without a change of consist and gross from 6,500 to 13,500 tons; a car in a local freight may move only a couple of miles and represent the entire train consist. Dedicated piggyback trains may be limited to 25 to 50 cars and may run over several railroads with few, if any, intermediate stops to set out and pick up blocks of cars at major terminals. This variation in rail movements also occurs on the micro scale, such as at individual highway-rail grade crossings. Thus, the design of traffic control systems at crossings must allow for a wide variation in train length, train speed, and train occurrence.

Long trains, such as unit trains, directly affect the operation of highway traffic over crossings and indirectly affect safety as well. Unit trains consist of

⁴⁵ *Guidance on Traffic Control Devices at Highway-Rail Grade Crossings*. Washington, DC: FHWA, Highway/Rail Grade Crossing Technical Working Group, November 2002.

⁴⁶ Bureau of Transportation Statistics Website (www.bts.gov).

as many as 100 freight cars with the same lading. Coal and grain are two major commodities transported in unit trains. Because of their lengths, unit trains will take longer to pass over a crossing and, in effect, close the crossing to highway traffic for a longer period of time.

In addition, some communities have passed ordinances restricting train speed for the purpose of improving safety. However, this practice directly reduces the level of service for highway traffic and may also affect safety. Because of the longer period of time during which the crossing is closed to highway traffic, a motorist may take risks by passing over the crossing just ahead of a train. In many cases, risks such as these are not successful, and collisions result.

Trains other than unit trains typically consist of a variety of cars and loadings. A few cars may be picked up along the way and may be dropped off from the same train or may be taken to a railroad yard where a new train is made up of cars with similar destinations. It is obvious that trains must stop to pick up cars, but it is unfortunate that some of these pick-up points are located in the central portion of communities. This results in trains moving slowly over the crossing or even standing on the crossing as the pick-up is made. With the lengths of freight trains today, an entire community can be physically divided by a freight train stopped on all of its crossings.

Railroads have operating procedures designed to prevent extensive blockage of crossings, and many states have passed regulations prohibiting the blockage of crossings for various lengths of time. Twenty-eight states expressly prohibit trains from blocking crossings for a period that varies from 5 to 20 minutes. Of these, 10 states exempt moving trains.⁴⁷ A freight train can be divided to allow highway traffic to pass through, but this practice requires the braking system to be filled with air, which can take considerable time. Changes in operating practices that may assist in the alleviation of these types of problems are discussed further in Chapter IV, Identification of Alternatives.

Railroads carry passengers in addition to freight, although this mode of transportation has declined during recent decades due to the construction of the interstate highway system, the convenience of the automobile, and the speed of the airplane. Amtrak, the National Railroad Passenger Corporation, provides passenger service nationwide. Created by Congress in 1971, Amtrak operates over track owned by itself

(primarily in the northeast) and by other railroad companies. In accordance with labor agreements, employees of privately-owned railroad companies operate Amtrak passenger trains over that railroad's trackage.

Some private railroad companies continue to operate passenger trains, particularly for commuter service in urban areas. Some municipal, regional, and state authorities have taken over railroad commuter services. Many light-rail transit companies are in operation and are being constructed in the United States with numerous crossings and longitudinal street use. (These are not normally considered railroads in tabulating crossing collisions.) On the heavy-rail rapid transit systems, there are few crossings of public highways at grade.

Locomotives and cars obviously form a train, but for crossing purposes, any rail operation over a highway is of concern, whether it is one or more engines or a group of cars pushed over a crossing. Most locomotives today are diesel-electric or straight electric, although some railroads operate steam locomotives as special passenger trains for historical purposes. In 1983, 25,838 locomotive units were in service on Class I railroads; all but 63 of these units were diesel-electric.

Headlights. All locomotives are equipped with headlights that are illuminated whenever the locomotive is in motion. One type of light is a 30-volt, 200-watt PAR-56 sealed beam lamp with an output of 200,000 to 300,000 candlepower. The lamp is usually used in pairs. Some railroads use oscillating headlights, comprising one or more standard locomotive headlight lamps on a mounting plate moved by a small motor in a figure eight, circular, or oval pattern. The light beam thus "sweeps" across the tracks.

Several types of roof lights are sometimes used on locomotives to serve as markers in yards so that the locomotive can be easily located among numerous freight cars. These types of roof lights include beacon lights, strobe lights, and sequentially flashing lights. In an effort to make the locomotive as visible as possible, some railroads utilize these types of lights at highway-rail grade crossings, either illuminating them whenever the locomotive is in motion or illuminating them in advance of crossings.

The Federal Railroad Administration (FRA) considered a regulation that would require the mandatory use of strobe lights or, in a later proposed rulemaking, the use of any of the four types of roof lights at crossings. However, based on information received in response to the proposed rulemakings and on an in-depth

47 "Compilation of State Laws and Regulations on Matters Affecting Highway-Rail Crossings" (www.fra.dot.gov).

analysis of costs and benefits, FRA concluded that the information in the docket does not support the proposition that alerting lights are effective in reducing the incidence of grade crossing collisions. Without that support, a federal regulatory requirement that railroads equip their locomotives with an alerting light is not justified.⁴⁸

FRA issued a Final Rule on locomotive headlights, 49 CFR 229, effective March 16, 2004, which clarified FRA requirements for locomotive lighting, including the requirement for auxiliary lighting. The revised regulations are in Section 229.125, and the auxiliary lights are to be placed at the front of the locomotive to form a triangle with the headlight.⁴⁹

Train horns and quiet zones. Locomotives are equipped with air-powered horns to sound a warning of a train’s approach to a crossing and for various other signals in railroad operations. Under current rules, FRA requires the horn to produce a minimum sound level of 96db(A) and a maximum of 110 db(A) at 100 feet forward of the locomotive. The locomotive engineer sounds the horn in advance of a crossing in a sequence of two long blasts, followed by a short blast, then followed by one long blast.

On April 27, 2005, FRA published in the Federal Register provisions of 49 CFR 222, “Use of Locomotive Horns at Highway-Rail Grade Crossings,” which determines when the horn is sounded at public crossings (and at private crossings within “quiet zones”). The Final Rule, which took effect on June 24, 2005, preempts various existing state laws and railroad operating rules and allows for the establishment of quiet zones. A summary of this rule follows on the next page.⁵⁰

On August 17, 2006, FRA published amendments to the Final Rule in the Federal Register. Effective September 18, 2006, the amendments extended the compliance date of time-based locomotive horn sounding until December 15, 2006. Among the other rule changes were provisions that expanded the time-based requirements to include all locomotive audible devices; provided an exception to the 15-second minimum locomotive horn sounding requirement for trains that re-initiate movement after having stopped in close proximity to a

public highway-rail grade crossing; indicated that the time-based criteria for sounding the horn pertains to pedestrian and private crossings in states that require horn sounding at such locations; and clarified that locomotives used in rapid transit are exempt from the locomotive horn sound level requirements.

Additional information, including the full text of the Final Rule, the Final Environmental Impact Statement, and background documents, are available at the FRA Website.⁵¹

At the June 2006 meeting of NCUTCD, the council approved for adoption into the next edition of MUTCD language for Part 8, which incorporates those portions of the train horn rule that pertain to traffic control devices consistent with the Final Rule.

Reflectorization. Nearly one-quarter of all highway-rail grade crossing collisions involve motor vehicles running into trains occupying grade crossings. The large size and dark colorization of trains in combination with poor lighting or limited visibility may contribute to motorists having difficulty detecting the train in their path. Reflective material will help reduce the numbers and severity of this type of collision by giving motorists an additional visual warning of the presence of a train.

Reflectorization has become an indispensable tool for enhancing visibility and safety in virtually all modes of transportation. Extending the benefits of reflective materials to railroads will improve highway-rail grade crossing safety and prevent many avoidable collisions.

On January 3, 2005, FRA published a Final Rule on reflectorization of freight rolling stock, which took effect on March 4, 2005. Figure 1 shows an example of the reflectorization standards as applied to a boxcar.

FRA issued the Final Rule under 49 CFR 224 to mandate the reflectorization of freight rolling stock, including freight cars and locomotives, to enhance the visibility of trains to reduce the numbers and severity of collisions at highway-rail grade crossings in which train visibility is a contributing factor. The rule establishes a schedule for the application of retroreflective material and prescribes standards for the construction, performance, application, inspection, and maintenance of the material.

The Final Rule on Reflectorization of Rail Freight

48 “Display of Altering Lights by Locomotives at Public Rail-Highway Crossings: Termination of Rule Making.” Docket No. RSGC-2, Notice 4, Federal Register, Vol. 48, No. 88, Washington, DC, May 5, 1983.

49 U.S. DOT, FRA. 49 CFR Part 229, Railroad Locomotive Safety Standards: Clarifying Amendments; Headlights and Auxiliary Lights; Final Rule.

50 Developed from “The ‘Train Horn’ Final Rule Summary.” Washington, DC: FRA, 2005.

51 U.S. DOT, FRA. 49 CFR Parts 222 and 29 [Docket No. FRA-1999-6439, Notice No. 16] RIN 2130-AA71, Use of Locomotive Horns at Highway-Rail Grade Crossings.

QUIET ZONE RULE SUMMARY

Overview

The Final Rule on “quiet zones” is intended to:

- Maintain a high level of public safety.
- Respond to the varied concerns of many communities that have sought relief from unwanted horn noise.
- Take into consideration the interests of localities with existing whistle bans.

The public authority responsible for traffic control or law enforcement at the highway-rail grade crossing is the only entity that can designate or apply for quiet zone status.

Mandated by law, the Final Rule:¹

- Defines engineering solutions known as “supplementary safety measures” (SSMs) for use without FRA approval.
- Provides explicit flexibility for the modification of SSMs to receive credit as “alternative safety measures” (ASMs) (for instance, shorter traffic channelization arrangements can be used with reasonable effectiveness estimates).
- Includes a provision that provides risk reduction credit for pre-existing SSMs and pre-existing modified SSMs that were implemented prior to December 18, 2003.
- Allows use of education and enforcement options, including photo enforcement, subject to verification of effectiveness.

Local public authorities may designate or request approval of quiet zones in which train horns may not be routinely sounded. The details for establishment of quiet zones differ depending on the type of quiet zone to be created (pre-rule or new) and the type of safety improvements implemented (if required).

Once a quiet zone is established (including the continuation of pre-rule quiet zones pending any required improvements), the railroad is barred from routine sounding of the horn at the affected highway-rail grade crossings.

FRA provides a Web-based tool for communities to use in performing “what if” calculations and preparing submissions necessary to create or retain quiet zones. The tool may be found on the FRA Website.

To ensure proper application of the risk index, the National Highway-Rail Crossing Inventory must be accurate and complete. In the absence of timely filings to the inventory by the states or railroads, local authorities may file updated inventory information, and railroads must cooperate in providing railroad-specific data.

FRA regional personnel are available to participate in diagnostic teams evaluating options for quiet zones.

¹ 49 U.S.C. 20153.

Requirement to Sound the Locomotive Horn

Outside of quiet zones, railroads must sound the horn 15–20 seconds prior to a train’s arrival at the highway-rail grade crossing but not more than one-quarter-mile in advance of the crossing.

Note: Most existing state laws and railroad rules required that the horn be sounded beginning at a point one-quarter-mile in advance of the highway-rail grade crossing and continued until the crossing is occupied by the locomotive. Under the quiet zone rule, for trains running at less than 45 miles per hour, this reduces the time and distance over which the horn is sounded, thereby reducing noise impacts on local communities.

The pattern for sounding the horn will remain as it currently exists today (two long, one short, one long repeated or prolonged until the locomotive occupies the highway-rail grade crossing).

Train operators may vary this pattern as necessary where highway-rail grade crossings are closely spaced; they will also be empowered (but not required) to sound the horn in the case of an emergency, even in a quiet zone.

The rule addresses use of the horn only with respect to highway-rail grade crossings. Railroads remain free to use the horn for other purposes as prescribed in railroad operating rules on file with FRA, and railroads must use the horn as specified in other FRA regulations (in support of roadway worker safety and in the case of malfunctions of highway-rail grade crossing active warning devices).

The rule prescribes both a minimum and a maximum volume level for the train horn. The minimum level is retained at 96 dB(A), and the new maximum will be 110 dB(A). This range is intended to permit railroads to address safety needs in their operating territory (this issue is addressed in the preamble text of the Final Rule).

The protocol for testing the locomotive horn is altered to place the sound-level meter at a height of 15 feet above the top of the rail rather than the previous 4 feet above the top of the rail. (Cab-mounted and low-mounted horns continue to have the sound-level meter placed 4 feet above the top of the rail.)

Note: The effect of this change is to permit center-mounted horns to be “turned down” in some cases. The previous test method was influenced by the “shadow effect” created by the body of the locomotive to indicate a lower sound level than would otherwise be expected several hundred feet in front of the locomotive (where the crossing and approaching motorists are located).

The effect of these changes is expected to reduce noise impacts for 3.4 million of the 9.3 million people currently affected by train horn noise.

Creation of Quiet Zones

The rule provides significant flexibility to communities to create quiet zones, both where there are existing whistle bans and in other communities that heretofore have had no opportunity to do so.

The Final Rule permits implementation of quiet zones in low-risk locales without requiring the addition of safety improvements.

- This concept utilizes a risk index approach that estimates expected safety outcomes (that is, the likelihood of a fatal or non-fatal casualty resulting from a collision at a highway-rail crossing).
- Risk may be averaged over crossings in a proposed quiet zone.
- Average risk within the proposed quiet zone is then compared with the average nationwide risk at gated crossings where the horn is sounded (the “National Significant Risk Threshold” (NSRT)). FRA will compute the NSRT annually.

The effect of this approach is that horns can remain silenced in more than half of pre-rule quiet zones without significant expense; many new quiet zones can be created without significant expense where flashing lights and gates are already in place at the highway-rail grade crossings.

If the risk index for a proposed new quiet zone exceeds the NSRT, supplementary or alternative safety measures must be used to reduce that risk (to fully compensate for the absence of the train horn or to reduce risk below the NSRT).

Maintenance of Pre-Rule Quiet Zones

Train horns will not sound in existing whistle ban areas if authorities state their intention to maintain pre-rule quiet zones and do whatever is required (see above) within five years of the effective date (June 24, 2005; eight years if the state agency provides at least some assistance to communities in that state).

To secure pre-rule quiet zone status, communities must provide proper notification to FRA and other affected parties by June 3, 2005 and file a plan with FRA by June 24, 2008 (if improvements are required).

Horns may continue to be silenced at pre-rule quiet zones if:

- The average risk at the crossings is less than the NSRT; or
- The average risk is less than twice the NSRT and no relevant collisions have occurred within the past five years; or
- The community undertakes actions to compensate for lack of the train horn as a warning device (or at least to reduce average risk to below the NSRT).

Creation of New Quiet Zones

New quiet zones may be created if all public highway-rail grade crossings are equipped with flashing lights and gates; and either:

- After adjusting for excess risk created by silencing the train horn, the average risk at the crossings is less than the NSRT; or
- SSMS are present at each public crossing; or
- Safety improvements are made that compensate for loss of the train horn as a warning device (or at least to reduce average risk to below the NSRT).

Detailed instructions for establishing or requesting recognition of a quiet zone are provided in the regulation.

Length of Quiet Zones

Generally, a quiet zone must be at least one-half-mile in length and may include one or more highway-rail grade crossings.

Pre-rule quiet zones may be retained at the length that existed as of October 9, 1996, even if less than one-half-mile. A pre-rule quiet zone that is greater than one-half-mile may be reduced in length to no less than one-half-mile and retain its pre-rule status. However, if its length is increased from pre-rule length by the addition of highway-rail grade crossings that are not pre-rule quiet zone crossings, pre-rule status will not be retained.

Supplementary and Alternative Safety Measures

SSMs are engineering improvements that clearly compensate for the absence of the train horn. If employed at every highway-rail grade crossing in the quiet zone, they automatically qualify the quiet zone (subject to reporting requirements). They also may be used to reduce the average risk in the corridor to fully compensate for the lack of a train or to below the NSRT.

- Temporary closure used with a partial zone.
- Permanent closure of a highway-rail grade crossing.
- Four-quadrant gates.
- Gates with traffic channelization arrangements (for example, non-mountable curb or mountable curb with delineators) at least 100 feet in length on each side the crossing (60 feet where there is an intersecting roadway) and no commercial driveways included.
- One-way street with gate across the roadway.

ASMs may be applied such that the combination of measures at one or more highway-rail grade crossings reduces the average risk by the required amount across the quiet zone (so-called “corridor approach”).

- Any modified SSM (such as barrier gate and median; shorter channelization; raised median islands; longitudinal median separators); or
- Education and/or enforcement programs (including photo enforcement) with verification of effectiveness; or
- Engineering improvements, other than modified SSMs; or
- Combination of the above.

The rule provides that pre-existing SSMs and pre-existing modified SSMs will be counted toward risk reduction.

Recognition of the Automated Wayside Horn

The rule authorizes use of the automated wayside horn at any highway-rail grade crossing with flashing lights and gates (inside or outside a quiet zone) as a one-to-one substitute for the train horn.

Certain technical requirements apply, consistent with the successful demonstrations of this technology.

The Federal Highway Administration (FHWA) has issued an interim approval for the use of wayside horns as traffic control devices. Communities interested in employing this option should contact FHWA to ensure that they comply with the provisions of the interim approval.

Special Circumstances

A community or railroad that views the provisions of the rule inapplicable to local circumstances may request a waiver from the rule from FRA.

A railroad or community seeking a waiver must first consult with the other party and seek agreement on the form of relief. If agreement cannot be achieved, the party may still request the relief by a waiver, provided the FRA associate administrator determines that a joint waiver petition would not be likely to contribute significantly to public safety.

FRA grants waivers if in the public interest and consistent with the safety of highway and railroad users of the highway-rail grade crossings.

Other Provisions

The Final Rule addresses quiet zones that prohibit sounding of horns during the evening and/or nighttime hours. These are referred to as partial quiet zones.

The Final Rule requires diagnostic team reviews of pedestrian crossings located within proposed new quiet zones and new partial quiet zones.

The Final Rule requires quiet zone communities to retain automatic bells at public highway-rail grade crossings that are subject to pedestrian traffic.

The Final Rule extends “recognized state agency” status to state agencies that wish to participate in the quiet zone development process.

The Final Rule contains a 60-day comment period on quiet zone applications.

The Final Rule requires public authorities to provide notification of their intent to create a new quiet zone. During the 60-day period after the Notice of Intent is mailed, comments may be submitted to the public authority.

The Final Rule provides quiet zone risk reduction credit for certain pre-existing SSMS.

The Final Rule provides quiet zone risk reduction credit for pre-existing modified SSMS.

The Final Rule contains a new category of ASMs that addresses engineering improvements other than modified SSMS.

Figure 1. Reflectorization Example—Standards Applicable to Boxcars

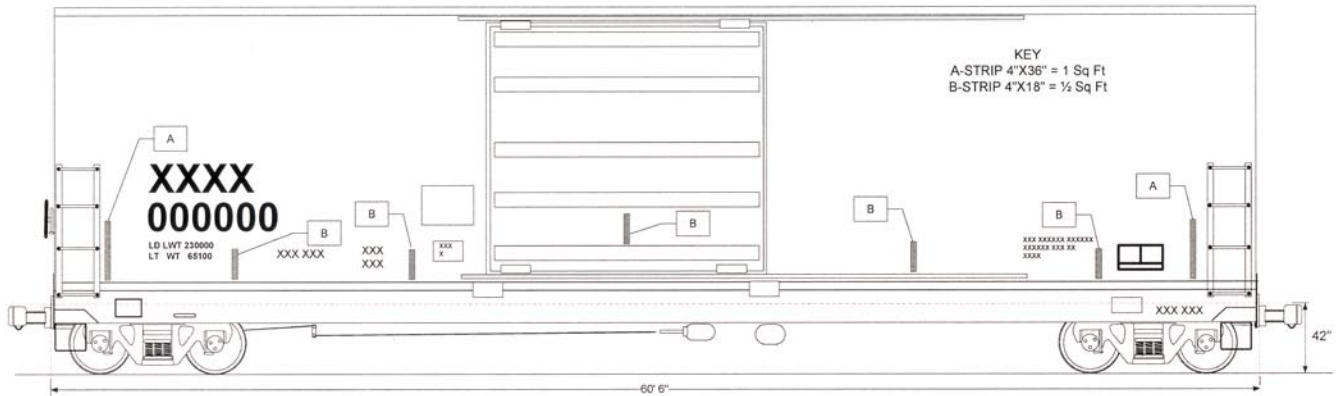

Figure 1
Yellow vertical reflective sheeting (4.5 sq. ft.) pattern applied to a typical 60' 6" Box Car (additional sheeting required per 49 CFR 224.105 if white sheeting is applied in lieu of yellow)

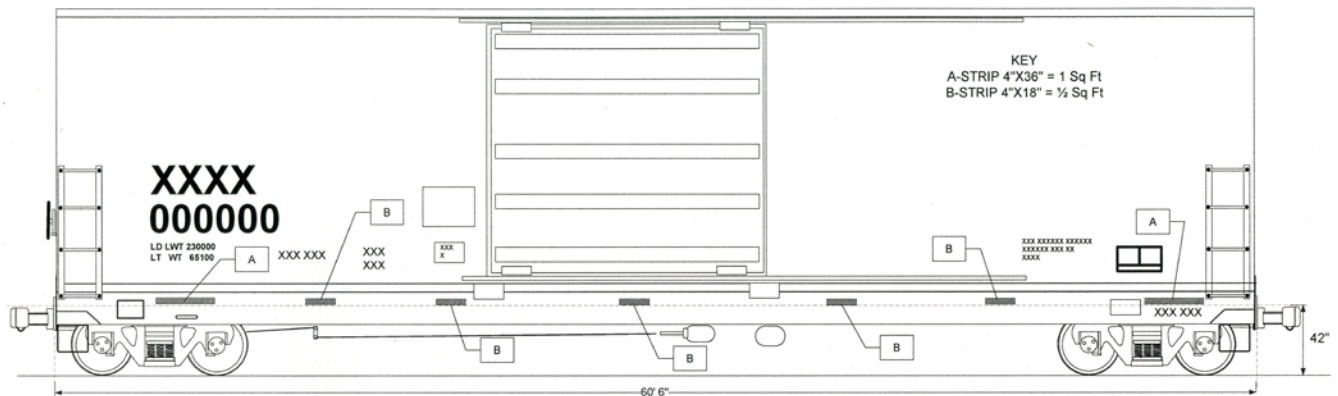

Figure 4
Alternate Pattern
Yellow horizontal reflective sheeting (4.5 sq. ft.) pattern applied to a typical 60' 6" Box Car (additional sheeting required per 49 CFR 224.105 if white sheeting is applied in lieu of yellow)

Source: 49 CFR Part 224, Final Rule, Reflectorization of Rail Freight Rolling Stock, Federal Railroad Administration, Docket Number FRA-1999-6899, Notice No. 6, Washington, DC, October 2005.

Rolling Stock requires railroads to install yellow or white reflective materials on locomotives over a five-year timeframe and on freight rail cars over a 10-year period. The reflective materials will be installed on all newly constructed locomotives and freight rail cars and on existing ones during periodic maintenance or repair, unless alternate implementation plans have been developed that meet the requisite timetables. The effective date of the rule is March 4, 2005.

Braking. Primarily because of their enormous weight, railroad trains are slow to accelerate and decelerate. Numerous factors affect a train's acceleration capability, such as the number of locomotive units, the horsepower rating of each unit and, of course, the number and weight of freight cars. At low speeds, a commuter train

may accelerate at 1.5 miles per hour (mph) per second; a fast freight may accelerate at 0.3 mph per second. As speed increases, the acceleration rate decreases. A freight with 4.0 horsepower per ton can accelerate at only about 0.1 mph per second at 70 mph.

The braking system used on trains is the air brake that provides adequate uninterrupted pressure from car to car. The single air hose at the end of each car is manually connected to its neighbor, then the brake system is charged. When braking is required, the pressure in the brake pipe leading back through the train is reduced. This causes the valve on each car to use air from the auxiliary reservoir to build pressure in the brake cylinder, thus applying the brakes. For an emergency application, the brake valve opens the

brake pipe to atmospheric pressure and the resulting rapid rate of brake pipe pressure reduction causes the car valves to dump the contents of both auxiliary and emergency reservoirs into the brake cylinder.

Braking distances are dependent on many factors that vary for each train, such as the number and horsepower rating of locomotives; number and weight of cars; adhesion of wheels on rails; speed; and grade. Therefore, the braking distance of a train cannot be stated exactly. An estimate is that a typical 100-car freight train traveling at 60 mph would require more than 1 mile to stop in emergency braking.

The majority of crossing collisions involve freight trains, as shown in Table 12.

Generally, crossings with higher numbers of trains per day would be expected to have more crossing collisions because the “exposure” (the number of trains per day multiplied by the number of cars per day) is higher for any given highway traffic level. Figure 2 shows the number of collisions in 2004 by the number of trains per day per crossing. Although Figure 2 indicates a dip in the number of collisions for crossings with 21 to 30 trains per day, due to the fact that there are fewer crossings with these activity levels, crossings with higher activity levels have higher collision rates as well.

2. Track

In the United States, railroad trackage is classified into six categories based upon maximum permissible operating speed. FRA’s track safety standards set maximum train speeds for each class of track, as shown in Table 13.

Table 12. Collisions at Public Crossings Involving Motor Vehicles by Type of Train, 2004

Type of train	Collisions
Freight	1,997
Passenger/commuter	227
Yard switching	167
Other*	232
Total	2,623

* Note: “Other” includes work trains, light locomotives, single car, cut of cars, maintenance/inspection car, and special maintenance-of-way equipment.

Source: Unpublished data from Federal Railroad Administration.

Figure 2. Number of Collisions by Number of Trains per Day per Crossing, 2004

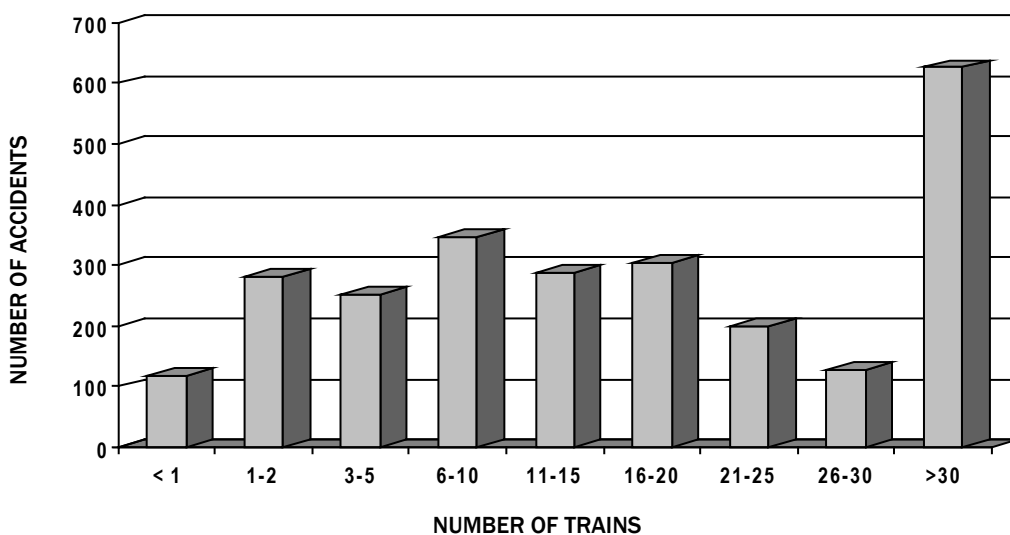

Source: Unpublished data from Federal Railroad Administration.

Table 13. Maximum Train Speeds by Class of Track*

Class of track	Freight	Passenger
Class 1	10 mph	15 mph
Class 2	25 mph	30 mph
Class 3	40 mph	60 mph
Class 4	60 mph	80 mph
Class 5	80 mph	90 mph
Class 6	110 mph	110 mph
Class 7	125 mph	125 mph
Class 8	160 mph	160 mph
Class 9	200 mph	200 mph

* Note: If train operations exceed 177 kilometers per hour (110 mph) for a track segment that will include highway-rail grade crossings, FRA's approval of a complete description of the proposed warning/barrier system to address the protection of highway traffic and high-speed trains must be obtained in advance. All elements of the warning/barrier system must be functioning.

Source: Track Safety Standards Compliance Manual. Washington, DC: Federal Railroad Administration, January 2002.

Initially, there were many different track gauges; however, in 1863, President Lincoln designated 4 feet, 8.5 inches as the gauge for the railroad to be built to the Pacific coast. Other railroads then began changing to this gauge.

The rolling resistance that provides many of the technological advantages for railroads as a means of transportation is made possible by the steel wheel rolling on a steel rail. This steel-wheel-to-steel-rail contact involves pressures of more than 50,000 pounds per square inch, which are then reduced to pressures acceptable to the underlying soil by a series of steps, going from the rail to a steel plate under the rail (tie plate), which spreads the load over a wooden tie, which spreads the load over rock or slag ballast, which spreads the load to a sub-ballast (usually gravel, cinders, or sand), which spreads the load to the subgrade consisting of either the native soil below or some superior material obtained off site.

Rail is rolled from high-quality steel. Rail being rolled today weighs from 115 to 140 pounds per yard and is 6 to 8 inches high. For the last 50 years, the standard rail length has been 39 feet for transportation in 40-foot cars. In track, these rails are held together by bolted joint bars or are welded end to end in long strings. Bolted joints are, however, less rigid than the rest of the rail so that the rail ends wear more rapidly. Continuously welded rail is often used today, particularly on mainline tracks. Rail is welded into lengths of about 1,500 feet and taken to the point of

installation. The remaining joints can be eliminated by field welding in place.

The steel rails are spiked to ties typically made of wood with preservative impregnated to prevent decay. The ties hold the rails to gauge, support the rail, distribute the load to the ballast, and provide flexibility to cushion impacts of the wheels on the rail. Prestressed concrete ties have come into greater use on U.S. railroads in recent years but still represent less than 1 percent of the ties in use in the United States

Spikes or other rail fasteners are used to connect the rail to the ties for the primary purpose of preventing the rail from shifting sideways. Because rail has a tendency to move lengthwise, rail anchors are used, particularly on heavy-duty track.

Ballast is used to hold the ties in place, to prevent lateral deflections, and to spread out the load that averages about 100 pound-force per square inch just underneath the tie. Ballast must be able to resist degradation from the effects of tie motion that generate "fines" that may "cement" into an impervious mass. Ballast must also provide good drainage, which is especially important for the strength of the subgrade and also prevents mud from working its way up to contaminate the ballast.

Railway track is normally maintained by sophisticated, high production, mechanized equipment. Track surface is maintained by tamping machines that raise the track and compact the ballast under the ties. In this process, it is often necessary to raise the track a few inches. The best track stability will occur if this raise can continue through the crossing area instead of leaving a dip in the track. Lowering track is a very costly operation and can lead to subgrade instability problems.

Track components are generally replaced as needed. A typical heavy-duty freight line on tangent may be surfaced every two years, have about 25 percent of its ties renewed every eight years, and have its rail changed every 12 years.

Similar to highways, railroad track is classified into several categories dependent on its utilization in terms of traffic flow. Main tracks are used for through train movements between and through stations and terminals. Branch line trackage typically carries freight from its origin to the mainline on which it moves to its destination or to another branch line to its destination. Passing tracks, sometimes called sidings, are used for meeting and passing trains. Side tracks and industrial tracks are used to store cars and to load or unload them.

Table 14. Public At-Grade Crossings by Type of Track, 2005

Other tracks	Main tracks							Total
	0	1	2	3	4	5	> 5	
0	9	92,421	8,642	298	53	3	1	101,427
1	13,271	17,901	1,913	60	11	-	1	33,157
2	2,756	4,997	633	41	12	-	1	8,440
3	761	1,325	183	13	13	-	-	2,295
4	230	425	79	6	6	3	1	750
5	98	161	48	4	-	1	1	313
> 5	78	150	44	1	3	-	-	276
Total	17,203	117,380	11,542	423	98	7	5	146,658

Source: Unpublished data from Federal Railroad Administration.

FRA reports that, as of 2005, 92,421 public at-grade crossings consist of one main track only. “Main” track is one that carries through movement as opposed to switching movements or terminal movements. Therefore, branch lines have a main track, as do mainlines. Table 14 shows public at-grade crossings by number of main and other tracks.

Collision statistics show that the majority of collisions occur on main tracks. This is, of course, due to the fact that there are more crossings with main tracks and, generally, more train traffic moves over main tracks. Various collision databases (such as FRA, railroads, and local jurisdictions) have varying reporting thresholds and methodologies. Consequently, the specific number of collisions may vary between these databases. Table 15 shows track class and permissible speeds.

3. Signaling

During the early years of railroading, methods had to be devised to ensure that two trains did not meet at the same time on the same section of track. This was initially accomplished through the use of timetables and train orders. Block signal systems were developed, which indicated to the locomotive engineer whether or not a train was ahead in the next block of track. These signals were set manually until the track circuit was developed, which sensed the presence of a train in the block and set the signals automatically. The track circuit was designed to be fail-safe, so that if the battery or any wire connections were to fail or if a rail was broken, a clear signal would not be displayed. Insulated joints were used to define the limits of the block. Various types of track circuits are utilized in automatic traffic control device installations at

highway-rail grade crossings. (Refer to discussion in Chapter IV for specifics on train detection.)

C. References

Accident/Incident Bulletin. Washington, DC: Federal Railroad Administration (FRA), published annually.

Armstrong, John H. *The Railroad: What It Is, What It Does*. Omaha, Nebraska: Simmons-Boardman Publishing Corp., 1982.

Code of Federal Regulations, Title 23, Washington, DC: General Services Administration, published annually.

“Display of Alerting Lights by Locomotives at Public Rail-Highway Crossings.” Termination of Rulemaking, Docket No. RSGC-2, Notice 4. Washington, DC: Federal Register, Vol. 48, No. 88, May 5, 1983.

Poage, J.L., J.C. Pomfret, and J.B. Hopkins. *Freight Car Reflectorization*. Washington, DC: FRA, Report FRA-RRS83-1, December 1982.

A Policy on Geometric Design of Highway and Streets. Washington, DC: American Association of State Highway and Transportation Officials, 2001.

Post, T.J., G.J. Alexander, and H. Lunenfeld. *A User’s Guide to Positive Guidance, Second Edition*. Washington, DC: Federal Highway Administration, Report FHWA-TO-81-1, December 1981.

Rail-Highway Crossing Accident/Incident and Inventory Bulletin. Washington, DC: FRA, published annually.

Table 15. Track Class and Permissible Speeds

Track class	Maximum permissible speed	
	Freight	Passenger
Excepted	10 mph (16 km/hr.)*	Not permitted
Class 1	10 mph (16 km/hr.)	15 mph (24 km/hr.)
Class 2	25 mph (40 km/hr.)	30 mph (48 km/hr.)
Class 3	40 mph (64 km/hr.)	60 mph (96 km/hr.)
Class 4	60 mph (96 km/hr.)	80 mph (128 km/hr.)**
Class 5	80 mph (128 km/hr.)	90 mph (144 km/hr.)
Class 6	110 mph (176 km/hr.)	110 mph (176 km/hr.)
Class 7	125 mph (200 km/hr.)	125 mph (200 km/hr.)
Class 8	160 mph (256 km/hr.)	160 mph (256 km/hr.)
Class 9	200 mph (320 km/hr.)	200 mph (320 km/hr.)

* No more than five cars loaded with hazardous material are permitted within any single train.

** Amtrak trains are limited to 79 mph (126 km/hr.) unless cab signaling or automatic train stop is provided.

Source: Federal Railroad Administration.

Railroad Facts. Washington, DC: Association of American Railroads, October 1984.

Railroad/Highway Grade Crossing Accidents Involving Trucks Transporting Bulk Hazardous Materials, A Special Study. Washington, DC: National Transportation Safety Board, Report NTSB-HZM-81-2, September 1981.

Bussell, Eugene, R., Beverly Narum, Charles L. Amos, and John M. Schercinger. *Compilation*

of State Laws and Regulations on Matters Affecting Rail-Highway Crossings. Washington, DC: FRA, Report FHWA-TS-83-203, April 1983.

Traffic Control Devices Handbook. Washington, DC: Institute of Transportation Engineers, 2001.

Uniform Vehicle Code and Model Traffic Ordinance. National Committee on Uniform Traffic Laws and Ordinances, Evanston, Illinois, 1961 and Supplement, 1984.

Assessment of Crossing Safety and Operation



The Federal Highway Administration (FHWA) requires each state to develop and implement a highway safety improvement program (HSIP) that consists of three components: planning, implementation, and evaluation. The process for improving safety and operations at highway-railroad grade crossings consists of the same three components and may be considered part of a state's HSIP.

FHWA policy and procedures for an HSIP are contained in the Federal-Aid Policy Guide (FAPG) Title 23—Code of Federal Regulations (and Non-regulatory Supplements). The objective of an HSIP is to reduce “the number and severity of accidents” and decrease “the potential for accidents on all highways.” FAPG 924 requires the planning component to consist of:

- A process for collecting and maintaining a record of collision, traffic, and highway data, including, for highway-rail grade crossings, the characteristics of both highway and train traffic.
- A process for analyzing available data to identify highway locations, sections, and elements determined to be hazardous on the basis of collision experience or collision potential.
- A process for conducting engineering studies of hazardous locations, sections, and elements to develop highway safety improvement projects.
- A process for establishing priorities for implementing highway safety improvement projects.

The implementation component consists of a process for programming and implementing safety improvements. The evaluation component consists of a process for determining the effect that safety improvements have in reducing the number and severity of collisions and potential collisions.

This section of the *Railroad-Highway Grade Crossing Handbook—Revised Second Edition* provides guidance for the planning component, consisting of the collection and maintenance of data, the analysis of data, and engineering studies. In addition, the “systems approach,” a method by which several crossings are studied collectively, is discussed. Chapter IV identifies the various crossing improvements available. Chapter V presents guidelines for selecting improvements based on safety and operational effectiveness and costs. Chapter VI provides guidelines for the implementation component of the safety program, Chapter VII discusses maintenance programs, and Chapter VIII addresses the evaluation component.

A. Collection and Maintenance of Data

A systematic method for identifying problem locations is most important. For highway-railroad grade crossings, two types of information are needed: inventory and collision data. Inventory data include the location of the crossing, volumes of highway and train traffic over the crossing, and physical elements of the crossing. Collision data for each crossing are also needed.

1. U.S. Department of Transportation Grade Crossing Inventory

FAPG 924.9(a)(1) specifies that each state maintain “a process for collecting and maintaining a record of accident, traffic, and highway data, including, for railroad-highway grade crossings, the characteristics of both highway and train traffic.” State maintenance of the U.S. Department of Transportation (U.S. DOT) National Highway-Rail Crossing Inventory will satisfy this survey requirement. State inventories containing data similar to that provided in the national inventory will also suffice.

Figure 3. U.S. DOT Crossing Inventory Form

DEPARTMENT OF TRANSPORTATION
FEDERAL RAILROAD ADMINISTRATION (FRA)

OMB Control No. 2130-0017
Expires: 7/31/2006

A. Initiating Agency <input type="checkbox"/> Railroad <input type="checkbox"/> State	B. Crossing Number (max. 7 char.)	C. Reason for Update <input type="checkbox"/> Changes in Existing Data <input type="checkbox"/> New Crossing <input type="checkbox"/> Closed Crossing or Abandoned	D. Effective Date (MM/DD/YYYY)
--	-----------------------------------	---	--------------------------------

Part I: Location and Classification Information

1. Railroad Oper. Co. (code (max. 4 char.) or name)		2. State (2 char.)	3. County (max. 20 char.)
4. Railroad Division or Region (max. 14 char.)	5. Railroad Subdivision or District (max. 14 char.)	6. Branch or Line Name (max. 15 char.)	7. RR Milepost (max. 7 char.) (nnnn.nn)
8. RR I.D. No. (max. 10 char.)	9. Nearest RR Timetable Station (max. 15 char.) (optional)	10. Parent RR (max. 4 char.) (if applicable)	11. Crossing Owner (RR or Company name) (if applicable)
12. City (max. 16 char.) (check <input type="checkbox"/> In <input type="checkbox"/> Near one)		13. Street or Road Name (max. 17 char.)	STATE SUPPLIED INFORMATION
14. Highway Type & No. (max. 7 char.)	15. ENS Sign Installed (1-800) <input type="checkbox"/> Yes <input type="checkbox"/> No	16. Quiet Zone <input type="checkbox"/> No <input type="checkbox"/> Partial <input type="checkbox"/> 24 hr <input type="checkbox"/> Unknown	21. HSR Corridor ID (2 char.)
17. Crossing Type (choose one only) <input type="checkbox"/> Public <input type="checkbox"/> Private <input type="checkbox"/> Pedestrian	18. Crossing Position <input type="checkbox"/> At Grade <input type="checkbox"/> RR Under <input type="checkbox"/> RR Over	19. Type of Passenger Service <input type="checkbox"/> AMTRAK <input type="checkbox"/> AMTRAK & Other <input type="checkbox"/> Other <input type="checkbox"/> None	20. Average Passenger Train Count Per Day _____
26. Is There an Adjacent Crossing With a Separate Number? <input type="checkbox"/> Yes <input type="checkbox"/> No If Yes, Provide Number _____ (7 characters)			22. County Map Ref. No. (max. 10 char.)
			23. Latitude (max. 10 char., nn.nnnnnnn)
			24. Longitude (max. 11 char., nnn.nnnnnnn)
			25. Lat/Long Source <input type="checkbox"/> Actual <input type="checkbox"/> Estimated

27. PRIVATE CROSSING INFORMATION			
27.A. Category (check one) <input type="checkbox"/> Recreational <input type="checkbox"/> Farm <input type="checkbox"/> Residential <input type="checkbox"/> Industrial <input type="checkbox"/> Commercial	27.B. Public Access <input type="checkbox"/> Yes <input type="checkbox"/> No <input type="checkbox"/> Unknown	27.C. Signs/Signals <input type="checkbox"/> None <input type="checkbox"/> Signs Specify (max. 15 char.) _____ <input type="checkbox"/> Signals Specify (max. 15 char.) _____	

28.A. Railroad Use (max. 20 char.)	29.A. State Use (max. 20 char.)
28.B. Railroad Use (max. 20 char.)	29.B. State Use (max. 20 char.)
28.C. Railroad Use (max. 20 char.)	29.C. State Use (max. 20 char.)
28.D. Railroad Use (max. 20 char.)	29.D. State Use (max. 20 char.)

30. Narrative (max. 100 char.)

31. Emergency Contact (Telephone No.)	32. Railroad Contact (Telephone No.)	33. State Contact (Telephone No.)
---------------------------------------	--------------------------------------	-----------------------------------

MUST COMPLETE REMAINDER OF FORM FOR PUBLIC VEHICLE CROSSINGS AT GRADE

Part II: Railroad Information

1. Number of Daily Train Movements			
1.A. Total Trains _____	1.B. Total Switching Trains _____	1.C. Total Daylight Thru Trains (6 AM to 6 PM) _____	1.D. Check if Less Than One Movement Per Day <input type="checkbox"/>
2. Speed of Train at Crossing			
2.A. Maximum Time Table Speed (mph) _____			
2.B. Typical Speed Range Over Crossing (mph) from _____ to _____			
3. Type and Number of Tracks			
Main _____ Other _____ If Other, Specify (max. 10 char.) _____			
4. Does Another RR Operate a Separate Track at Crossing? <input type="checkbox"/> Yes If Yes, Specify RR (max. 16 char.) <input type="checkbox"/> No		5. Does Another RR Operate Over Your Track at Crossing? <input type="checkbox"/> Yes If Yes, Specify RR (max. 16 char.) <input type="checkbox"/> No	

U.S. DOT CROSSING INVENTORY FORM

B. Crossing Number (max. 7 char.)	PAGE 2	D. Effective Date (MM/DD/YYYY)
-----------------------------------	---------------	--------------------------------

Part III: Traffic Control Device Information

1. No Signs or Signals <input type="checkbox"/> Check if Correct	2. Type of Warning Device at Crossing - Signs (specify number of each)				
2.A. Crossbucks: _____	2.B. Highway Stop Signs (R1-1) _____	2.C. RR Advance Warning Signs (W10-1) <input type="checkbox"/> Yes <input type="checkbox"/> No	2.D. Hump Crossing Sign (W10-5) <input type="checkbox"/> Yes <input type="checkbox"/> No <input type="checkbox"/> Unknown		
2.E. Pavement Markings <input type="checkbox"/> Stoplines <input type="checkbox"/> RR Xing Symbols <input type="checkbox"/> None		2.F. Other Signs: (specify MUTCD type) Number _____ Specify Type (max. 10 char.) _____ Number _____ Specify Type (max. 10 char.) _____			
3. Type of Warning Device at Crossing - Train Activated Devices (specify number of each)					
3.A. Gates _____	3.B. Four-quadrant (or full barrier) Gates <input type="checkbox"/> Yes <input type="checkbox"/> No	3.C. Cantilevered (or Bridged) Flashing Lights: Over Traffic Lane (number) _____ Not Over Traffic Lane (number) _____	3.D. Mast Mounted Flashing Lights (number) _____	3.E. Number of Flashing Light Pairs _____	
3.F. Other Flashing Lights: Number _____ Specify Type (max. 9 char.) _____		3.G. Highway Traffic Signals (number) _____	3.H. Wigwags (number) _____	3.I. Bells (number) _____	
3.K. Other Train Activated Warning Devices: (specify) (max. 9 char.) _____					
4. Specify Special Warning Device NOT Train Activated (max. 20 char.) _____			5. Channelization Devices With Gates <input type="checkbox"/> All Approaches <input type="checkbox"/> One Approach <input type="checkbox"/> None		
6. Train Detection <input type="checkbox"/> Constant Warning Time <input type="checkbox"/> DC/AFO <input type="checkbox"/> Motion Detectors <input type="checkbox"/> Other <input type="checkbox"/> None		7. Signalling for Train Operation: Is Track Equipped with Train Signals? <input type="checkbox"/> Yes <input type="checkbox"/> No		8. Traffic Light Interconnection/Preemption <input type="checkbox"/> Not Interconnected <input type="checkbox"/> N/A <input type="checkbox"/> Simultaneous Preemption <input type="checkbox"/> Advance Preemption	
9. Reserved For Future Use	10. Reserved For Future Use	11. Reserved For Future Use	12. Reserved For Future Use		

Part IV: Physical Characteristics

1. Type of Development <input type="checkbox"/> Open Space <input type="checkbox"/> Residential <input type="checkbox"/> Commercial <input type="checkbox"/> Industrial <input type="checkbox"/> Institutional			2. Smallest Crossing Angle <input type="checkbox"/> 0° - 29° <input type="checkbox"/> 30° - 59° <input type="checkbox"/> 60° - 90°		
3. Number of Traffic Lanes Crossing Railroad _____		4. Are Truck Pullout Lanes Present? <input type="checkbox"/> Yes <input type="checkbox"/> No		5. Is Highway Paved? <input type="checkbox"/> Yes <input type="checkbox"/> No	
6. Crossing Surface (on main line) <input type="checkbox"/> 1. Timber <input type="checkbox"/> 2. Asphalt <input type="checkbox"/> 3. Asphalt and Flange <input type="checkbox"/> 4. Concrete <input type="checkbox"/> 5. Concrete and Rubber <input type="checkbox"/> 6. Rubber <input type="checkbox"/> 7. Metal <input type="checkbox"/> 8. Unconsolidated <input type="checkbox"/> 9. Other (Specify) _____					
7. Does Track Run Down a Street? <input type="checkbox"/> Yes <input type="checkbox"/> No		8. Nearby Intersecting Highway? <input type="checkbox"/> Less than 75 feet <input type="checkbox"/> 75 to 200 feet <input type="checkbox"/> 200 to 500 feet <input type="checkbox"/> N/A Is it Signalized? <input type="checkbox"/> Yes <input type="checkbox"/> No			
9. Is Crossing Illuminated? (street lights within approx. 50 feet from nearest rail) <input type="checkbox"/> Yes <input type="checkbox"/> No		10. Is Commercial Power Available? <input type="checkbox"/> Yes <input type="checkbox"/> No		11. Space Reserved For Future Use	

Part V: Highway Information

1. Highway System <input type="checkbox"/> Interstate <input type="checkbox"/> Federal Aid, Not NHS <input type="checkbox"/> Nat. Hwy System (NHS) <input type="checkbox"/> Non Federal Aid		2. Is Crossing on State Highway System? <input type="checkbox"/> Yes <input type="checkbox"/> No		3. Functional Classification of Road at Crossing _____		4. Posted Highway Speed _____	
5. Annual Average Daily Traffic (AADT) Year _____ AADT _____		6. Estimate Percent Trucks _____		7. Average Number of School Buses Over Crossing per School Day _____			

Paperwork Reduction Act: Public reporting for this information collection is estimated to average 15 minutes per response, including the time for reviewing instructions, searching existing data sources, gathering and maintaining the data needed, and completing and reviewing the collection of information. According to the Paperwork Reduction Act of 1995, no persons are required to respond to a collection of information unless it displays a currently valid OMB Control Number. The valid OMB Control Number for this collection is 2130-0017.

Source: U.S. Department on Transportation Website (www.dot.gov).

The U.S. DOT National Highway-Rail Crossing Inventory was developed in the early 1970s through the cooperative efforts of FHWA, the Federal Railroad Administration (FRA), the Association of American Railroads (AAR), individual states, and individual railroads. Each crossing was surveyed—both public and private, grade separated and at grade—and data were recorded on the inventory form, as shown in Figure 3. The inventory contains data on the location of the crossing, the amount and type of highway and train traffic, traffic control devices, and other physical elements of the crossing.

Each crossing was assigned a unique identification number consisting of six numeric characters and an alphabetic character. The alphabetic character provides an algorithmic check of the six numeric characters. To determine the correct alphabetic character, sum the products of each of the first six digits times the digit's position (position one is the left-most digit). Divide this total sum by 22 and then interpolate the remainder according to the following:

0	-	A	6	-	G	12	-	N	17	-	U
1	-	B	7	-	H	13	-	P	18	-	V
2	-	C	8	-	J	14	-	R	19	-	W
3	-	D	9	-	K	15	-	S	20	-	X
4	-	E	10	-	L	16	-	T	21	-	Y
5	-	F	11	-	M						

The crossing identification number, shown in Figure 4, was installed at each crossing by attaching a tag to a crossbuck post or flashing light post. The two most common methods used to install permanent tags at a crossing are a metal tag on which the crossing number is embossed by raised imprinting and stenciling the number on the post.

Figure 4. Crossing Identification Number Tag

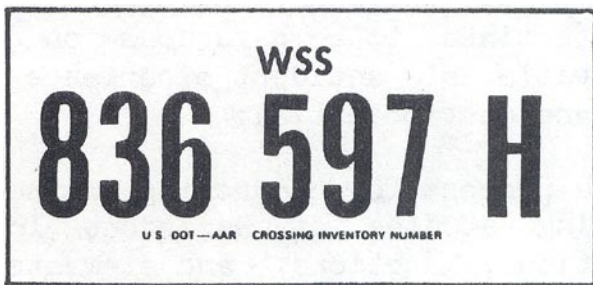

Source: Railroad-Highway Grade Crossing Handbook, Second Edition. Washington, DC: U.S. Department of Transportation, Federal Highway Administration, 198

FRA serves as custodian of the national inventory file. Data in the inventory are kept current through the voluntary submission of information by the states and railroads. Because the national inventory is updated by numerous states and railroads, systematic and uniform procedures are required to assist FRA in processing the data. Two basic procedures have been developed.

Individual update forms. This is the procedure originally developed for updating the national inventory. Whenever a change occurs at a crossing, such as the installation of traffic control devices, the railroad or state initiates an update form. This involves completing the following identification data elements on the form: crossing identification number; effective date of the change; state; county; railroad; and type of update, such as a change at an existing crossing, a new crossing, or a closed crossing. Other data elements are completed only if they have changed or if they were not previously reported, such as for a new crossing.

To ensure that the state and railroad are in agreement on the elements contained in the inventory, a process was developed by which each would have the opportunity to review an update initiated by the other. If the railroad initiates the update, it retains a copy of the form and sends the original to the state agency. The state reviews the information and makes any appropriate changes. It then sends a copy back to the railroad for its files and sends the original to FRA for processing.

If a state initiates the update, it retains a copy and sends the original to the railroad for its review. The railroad retains a copy for its files and returns the original to the state. The state retains a copy and submits the original to FRA for processing.

This procedure allows both the state and the railroad to concur on the crossing information prior to submittal to FRA, and establishes the state as the agency that submits all data to FRA. Another advantage of this procedure is that both the state and the railroad have a hardcopy record of the update that can be placed in a file along with the original inventory record.

The primary disadvantage of the individual form method is that the form must be completed for every change. This may result in a time-consuming effort, particularly for changes that affect a number of crossings. For example, if a railroad changes its operation over a route that results in an increase in the number of trains per day, an individual form would be completed for each crossing. To assist in these types of changes, FRA has established procedures for the mass updating of one or two data elements.

Electronic updates.⁵² Another updating procedure involves the submission of data via computer electronic file. This method is advantageous for states and railroads that maintain the inventory on a computer. A state or railroad may enter changes onto its own computer file and then periodically send FRA a file of the changes in a prescribed format. This method, once established, provides for the updating of the national file with relative ease. However, three cautions should be noted:

- The information contained in electronic files must be in the prescribed format. Because FRA receives information from 50 states and numerous railroads, it must be able to process the files without having to make any changes to format. Details on the required format can be obtained from FRA's Website.
- The electronic files should contain only changed information, not the entire crossing record. FRA's procedures create a new crossing record whenever any data element is changed. The national inventory consists of 2 million original crossing records.
- The other party must be provided with a copy of the changed information for its records.

FRA can provide information from the national inventory in three primary ways.

- One page per crossing printout: This is simply a computer-generated printout that contains all the information for a crossing on a single 8.5-inch by 11-inch sheet of paper. The information has been decoded and is easy to read. It is obtained from the FRA Website.
- Continuous feed form: This is identical to the individual form update that can be generated by computer.
- Lists: FRA will also generate, upon request, a list of specified information for specified crossings. This might be useful for obtaining current data on the elements contained in a priority index formula.

Data contained in the national inventory or a state inventory must be used with care. The data should be verified in the field, as discussed in a later section on engineering studies. The national inventory is used not only by states and railroads in conducting their crossing improvement programs but also by national and federal agencies in assessing crossing improvement needs and conducting research. Both states and railroads are urged to keep the information in this valuable database up to date.

⁵² Unpublished material provided by Tom Woll, Federal Railroad Administration (FRA), Washington, DC, 2006.

2. Grade Crossing Collision Data

Information on highway-rail grade crossing collisions is also needed to assess safety and operations. Data on collisions involving trains are essential in identifying crossings with safety problems. In addition, data on collisions not involving trains but occurring at or near a crossing are useful. For example, non-train-involved collisions may indicate a deficiency in stopping sight distance such that a vehicle suddenly stops at a crossing, causing the following vehicle to hit the leading vehicle in the rear.

Collision data are available from several sources, including state and local police and FRA. In addition, the National Highway Transportation Safety Administration (NHTSA) and FHWA maintain some information on crossing collisions.

Most state and local police maintain a record of all highway traffic collisions, including those occurring at or near crossings. It is essential that the police record the crossing identification number on the police accident report form. If the collision did not involve a train but occurred at or near a crossing, the crossing identification number should also be recorded on the police report form. Thus, collisions in which the presence of the crossing (regardless of the presence of a train) was a contributing factor to the collision can be identified. It is recommended that the police accident report form give the crossing identification number for collisions that occur within 200 feet of a crossing.

FRA requires each railroad to report any "impact between railroad on-track equipment and an automobile, bus, truck, motorcycle, bicycle, farm vehicle, or pedestrian at a rail-highway grade crossing."⁵³ The form used for the railroad to report highway-rail crossing collisions is shown in **Figure 5**. FRA prepares an annual summary of the collision data (and the national inventory data) entitled "Railroad Safety Statistics Annual Report." This document and other data contained in the collision data file can be obtained from FRA's Website.

NHTSA maintains a database on all fatal highway traffic collisions, including those occurring at highway-rail grade crossings. The Fatal Accident Reporting System (FARS) database can be accessed at www-fars.nhtsa.dot.gov.

The Federal Motor Carrier Safety Administration (FMCSA) maintains data on highway collisions

⁵³ Code of Federal Regulations, Title 49, Washington, DC: Superintendent of Documents, Government Printing Office, published annually.

Figure 5. Accident Report Form for Federal Railroad Administration

DEPARTMENT OF TRANSPORTATION
FEDERAL RAILROAD ADMINISTRATION (FRA)

HIGHWAY-RAIL GRADE CROSSING
ACCIDENT/INCIDENT REPORT

OMB Approval No.: 2130-0500

1. Name of Reporting Railroad		1a. Alphabetic Code		1b. Railroad Accident/Incident No.	
2. Name of Other Railroad Involved in Train Accident/Incident		2a. Alphabetic Code		2b. Railroad Accident/Incident No.	
3. Name of Railroad Responsible for Track Maintenance (single entry)		3a. Alphabetic Code		3b. Railroad Accident/Incident No.	
4. U. S. DOT Grade Crossing Identification Number		5. Date of Accident/Incident month day year		6. Time of Accident/Incident AM <input type="checkbox"/> PM <input type="checkbox"/>	
7. Nearest Railroad Station		8. Division		9. County	
				10. State Abbr. Code	
11. City (if in a city)		12. Highway Name or Number Public <input type="checkbox"/> Private <input type="checkbox"/>			
Highway User Involved			Rail Equipment Involved		
13. Type C. Truck-trailer A. Auto D. Pick-up truck B. Truck E. Van F. Bus G. School bus H. Motorcycle J. Other motor vehicle K. Pedestrian M. Other (specify)			17. Equipment 1. Train (units pulling) 2. Train (units pushing) 3. Train (standing) 4. Car(s) (moving) 5. Car(s) (standing) 6. Light loco(s) (moving) 7. Light loco(s) (standing) 8. Other (specify) A. Train pulling- RCL B. Train pushing- RCL C. Train standing- RCL		
14. Vehicle Speed (est. mph at impact)		15. Direction (geographical) 1. North 2. South 3. East 4. West		18. Position of Car Unit in Train	
16. Position 1. Stalled on crossing 2. Stopped on crossing 3. Moving over crossing 4. Trapped			19. Circumstance 1. Rail equipment struck highway user 2. Rail equipment struck by highway user		
20a. Was the highway user and/or rail equipment involved in the impact transporting hazardous materials? 1. Highway user 2. Rail equipment 3. Both 4. Neither			20b. Was there a hazardous materials release by 1. Highway user 2. Rail equipment 3. Both 4. Neither		
20c. State here the name and quantity of the hazardous material released, if any.					
21. Temperature (specify if minus) ° F		22. Visibility (single entry) 1. Dawn 2. Day 3. Dusk 4. Dark		23. Weather (single entry) 1. Clear 2. Cloudy 3. Rain 4. Fog 5. Sleet 6. Snow	
24. Type of Equipment 1. Freight train 2. Passenger train 3. Commuter train 4. Work train 5. Single car 6. Cut of cars 7. Yard/switching 8. Light loco(s). 9. Maint./inspect. car A. Spec. MoW Equip. Code			25. Track Type Used by Rail Equipment Involved 1. Main 2. Yard 3. Siding 4. Industry		26. Track Number or Name
27. FRA Track Class (1-9, X)		28. Number of Locomotive Units		29. Number of Cars	30. Consist Speed (Recorded speed, if available) R - Recorded E - Estimated MPH
32. Type of Crossing Warning 1. Gates 2. Cantilever FLS 3. Standard FLS 4. Wig wags 5. Hwy. traffic signals 6. Audible 7. Crossbucks 8. Stop signs 9. Watchman 10. Flagged by crew 11. Other (specify) 12. None			33. Signaled Crossing Warning (See reverse side for instructions and codes)		34. Whistle Ban 1. Yes 2. No 3. Unknown
35. Location of Warning 1. Both sides 2. Side of vehicle approach 3. Opposite side of vehicle approach		36. Crossing Warning Interconnected with Highway Signals 1. Yes 2. No 3. Unknown		37. Crossing Illuminated by Street Lights or Special Lights 1. Yes 2. No 3. Unknown	
38. Driver's Age	39. Driver's Gender 1. Male 2. Female	40. Driver Drove Behind or in Front of Train and Struck or was Struck by Second Train 1. Yes 2. No 3. Unknown		41. Driver 1. Drove around or thru the gate 2. Stopped and then proceeded 3. Did not stop 4. Stopped on crossing 5. Other (specify)	
42. Driver Passed Standing Highway Vehicle 1. Yes 2. No 3. Unknown		43. View of Track Obscured by (primary obstruction) 1. Permanent structure 2. Standing railroad equipment 3. Passing train 4. Topography 5. Vegetation 6. Highway vehicles 7. Other (specify) 8. Not obstructed			
Casualties to:		Killed	Injured	44. Driver was 1. Killed 2. Injured 3. Uninjured	
46. Highway-Rail Crossing Users				45. Was Driver in the Vehicle? 1. Yes 2. No	
49. Railroad Employees				48. Total Number of Highway-Rail Crossing Users (include driver)	
52. Passengers on Train				50. Total Number of People on Train (include passengers and train crew)	
				51. Is a Rail Equipment Accident/ Incident Report Being Filed? 1. Yes 2. No	
53a. Special Study Block			53b. Special Study Block		
54. Narrative Description (Be specific, and continue on separate sheet if necessary)					
55. Typed Name and Title			56. Signature		57. Date
NOTE: This report is part of the reporting railroad's accident report pursuant to the accident reports statute and, as such shall not be admitted as evidence or used for any purpose in any suit or action for damages growing out of any matter mentioned in said report . . . " 49 U.S.C. 20903. See 49 C.F.R. 225.7 (b).					

INSTRUCTIONS FOR COMPLETING BLOCK 33

Only if Types 1 - 6, Item 32 are indicated, mark in Block 33 the status of the warning devices at the crossing at the time of the accident, using the following codes:

1. Provided minimum 20-second warning.
2. Alleged warning time greater than 60 seconds.
3. Alleged warning time less than 20 seconds.
4. Alleged no warning.
5. Confirmed warning time greater than 60 seconds.
6. Confirmed warning time less than 20 seconds.
7. Confirmed no warning.

If status code 5, 6, or 7 was entered, also enter a letter code explanation from the list below:

- A. Insulated rail vehicle.
- B. Storm/lightning damage.
- C. Vandalism.
- D. No power/batteries dead.
- E. Devices down for repair.
- F. Devices out of service
- G. Warning time greater than 60 seconds attributed to accident-involved train stopping short of the crossing, but within track circuit limits, while warning devices remain continuously active with no other in-motion train present.
- H. Warning time greater than 60 seconds attributed to track circuit failure (e.g., insulated rail joint or rail bonding failure, track or ballast fouled, etc.).
- J. Warning time greater than 60 seconds attributed to other train/equipment within track circuit limits.
- K. Warning time less than 20 seconds attributed to signals timing out before train's arrival at the crossing/island circuit.
- L. Warning time less than 20 seconds attributed to train operating counter to track circuit design direction.
- M. Warning time less than 20 seconds attributed to train speed in excess of track circuit's design speed.
- N. Warning time less than 20 seconds attributed to signal system's failure to detect train approach.
- P. Warning time less than 20 seconds attributed to violation of special train operating instructions.
- R. No warning attributed to signal system's failure to detect the train.
- S. Other cause(s). Explain in Narrative Description.

involving motor carriers. A recordable collision is “an occurrence involving a commercial motor vehicle operating on a highway in engaged in interstate or intrastate commerce which results in (i) a fatality; (ii) Bodily injury to a person who, as a result of the injury, immediately receives medical treatment away from the scene of the accident; or, (iii) One or more motor vehicles incurring disabling damage as a result of the accident, requiring the motor vehicle(s) to be transported away from the scene by a tow truck or other motor vehicle.”⁵⁴

In the past, FMCSA required motor carriers to report crashes directly to the agency. This is no longer the case. This information is now forwarded by states. However, motor carriers must maintain accident registers for three years after the date of each accident occurring on or after April 29, 2003 (49 CFR 390.15). (Previously, the register had to be maintained for one year.) An example of a comprehensive state crash reporting form is included in Appendix C.

Collisions involving the transport of hazardous materials are reported to the Materials Transportation Bureau (MTB) of the Research and Special Programs Administration. An immediate telephone notice is required under certain conditions, and a detailed written report is required whenever there is any unintentional release of a hazardous material during transportation or temporary storage related to transportation. Collisions are to be reported when, as a direct result of hazardous materials: a person is killed; a person receives injuries requiring hospitalization; estimated carrier or other property damage exceeds \$50,000; or a situation exists such that a continuing danger to life exists at the scene of the incident. The form used for reporting these collisions to MTB is shown in Appendix D.

Significant transportation accidents are investigated by the National Transportation Safety Board (NTSB). NTSB issues a report for each accident investigated. The report presents the circumstances of the accident, the data collected, and the analysis of the data as well as conclusions, which are identified as “findings” of NTSB. In addition, NTSB issues specific recommendations to various parties for improvement of safety conditions. Appendix E provides summaries of a number of selected key grade crossing collision investigations provided by NTSB.

⁵⁴ Ibid.

B. Hazard Indices and Accident Prediction Formulae

A systematic method for identifying crossings that have the most need for safety and/or operational improvements is essential to comply with requirements of the FAPG, which specifies that each state should maintain a priority schedule of crossing improvements. The priority schedule is to be based on:

- The potential reduction in the number and/or severity of collisions.
- The cost of the projects and the resources available.
- The relative hazard of public highway-rail grade crossings based on a hazard index formula.
- On-site inspections of public crossings.
- The potential danger to large numbers of people at public crossings used on a regular basis by passenger trains, school buses, transit buses, pedestrians, bicyclists, or by trains and/or motor vehicle carrying hazardous materials.
- Other criteria as appropriate in each state.

Various hazard indices and collision prediction formulae have been developed for ranking highway-rail grade crossings. These are commonly used to identify crossings to be investigated in the field. Procedures for conducting the on-site inspection are discussed in the next section. Some hazard indices incorporate collision history as a factor in the ranking formula; if not, this factor should be subjectively considered.

1. Hazard Index

A hazard index ranks crossings in relative terms (the higher the calculated index, the more hazardous the crossing), whereas the collision prediction formulae are intended to compute the actual collision occurrence frequency at the crossing. A commonly used index is the New Hampshire Hazard Index ranking methodology (presented in Appendix F).

There are several advantages of using a hazard index to rank crossings. A mathematical hazard index enhances objectivity. It can be calculated by computer, facilitating the ranking process. As crossing conditions change, a computerized database can be updated and the hazard index recalculated.

In general, crossings that rank highest on the hazard index are selected to be investigated in the field by a diagnostic team, as discussed in the next section. Other

crossings may be selected for a field investigation because they are utilized by buses, passenger trains, and vehicles transporting hazardous materials. FAPG requires that the potential danger to large numbers of people at crossings used on a regular basis by passenger trains, school buses, transit buses, pedestrians, bicyclists, or by trains and/or motor vehicles carrying hazardous materials be one of the considerations in establishing a priority schedule. Some states incorporate these considerations into a hazard index, thus providing an objective means of assessing the potential danger to large numbers of people.

Some states, however, consider these factors subjectively when selecting the improvement projects among the crossings ranked highest by the hazard index. Other states utilize a point system so that crossings high on the hazard index receive a specified number of points, as do crossings with a specified number of buses, passenger trains, and vehicles transporting hazardous materials.

Other states utilize the systems approach, considering all crossings within a specified system, such as all crossings along a passenger train corridor.

Crossings may also be selected for field investigation as a result of requests or complaints from the public. State district offices, local governmental agencies, other state agencies, and railroads may also request that a crossing be investigated for improvement. A change in highway or railroad operations over a crossing may justify the consideration of that crossing for improvement. For example, a new residential or commercial development may substantially increase the volume of highway traffic over a crossing such that its hazard index would greatly increase.

2. U.S. Department of Transportation Accident Prediction Model

A prediction model is intended to predict, in absolute terms, the likelihood of a collision occurring over a given period of time given conditions at the crossing. The following discussion presents the accident prediction model developed by U.S. DOT. (Other formulae are presented in Appendix F.) Thus, an accident prediction model can also be used to either rank crossings or identify potential high-accident locations for further review.

The U.S. DOT collision prediction formula combines three independent calculations to produce a collision prediction value. The basic formula provides an initial hazard ranking based on a crossing's characteristics,

similar to other formulae such as the Peabody-Dimmick formula and the New Hampshire Index. The second calculation utilizes the actual collision history at a crossing over a determined number of years to produce a collision prediction value. This procedure assumes that future collisions per year at a crossing will be the same as the average historical collision rate over the time period used in the calculation. The third equation adds a normalizing constant, which is adjusted periodically to keep the procedure matched with current collision trends.

FRA has provided a Website where highway-rail intersection safety specialists may calculate the predicted collisions for any public highway-rail intersection in the national inventory.⁵⁵

The basic collision prediction formula can be expressed as a series of factors that, when multiplied together, yield an initial predicted number of collisions per year at a crossing. Each factor in the formula represents a characteristic of the crossing described in the national inventory. The general expression of the basic formula is shown below:

$$a = K \times EI \times MT \times DT \times HP \times MS \times HT \times HL \quad (1)$$

where:

- a = initial collision prediction, collisions per year at the crossing
- K = formula constant
- EI = factor for exposure index based on product of highway and train traffic
- MT = factor for number of main tracks
- DT = factor for number of through trains per day during daylight
- HP = factor for highway paved (yes or no)
- MS = factor for maximum timetable speed
- HT = factor for highway type
- HL = factor for number of highway lanes

Different sets of equations are used for each of the three categories of traffic control devices: passive, flashing lights, and automatic gates, as shown in Table 16.

The structure of the basic collision prediction formula makes it possible to construct tables of numerical values for each factor. To predict the collisions at a particular crossing whose characteristics are known, the values of the factors are found in the table and multiplied together. The factor values for the three

⁵⁵ FRA Office of Safety Website (safetydata.fra.dot.gov/officeofsafety).

Table 16. U.S. DOT Collision Prediction Equations for Crossing Characteristic Factors

General Form of Basic Accident Prediction Formula: $e = K \times EI \times MT \times DT \times HP \times MS \times HT \times HL$

Crossing Characteristic Factors								
Crossing Category	Formula Constant K	Exposure Index Factor EI	Main Tracks Factor MT	Day Thru Trains Factor DT	Highway Paved Factor HP	Maximum Speed Factor MS	Highway Type Factor HT	Highway Lanes Factor HL
Passive	0.002268	$\frac{c \times t + 0.2}{0.2}^{0.3334}$	$e^{0.2094mt}$	$\frac{d + 0.2}{0.2}^{0.1336}$	$e^{-0.6160(hp-1)}$	$e^{0.0077ms}$	$e^{-0.1000(ht-1)}$	1.0
Flashing Lights	0.003646	$\frac{c \times t + 0.2}{0.2}^{0.2953}$	$e^{0.1088mt}$	$\frac{d + 0.2}{0.2}^{0.0470}$	1.0	1.0	1.0	$e^{0.1380(hl-1)}$
Gates	0.001088	$\frac{c \times t + 0.2}{0.2}^{0.3116}$	$e^{0.2912mt}$	1.0	1.0	1.0	1.0	$e^{0.1036(hl-1)}$

<p>c = annual average number of highway vehicles per day (total both directions)</p> <p>t = average total train movements per day</p> <p>mt = number of main tracks</p> <p>d = average number of thru trains per day during daylight</p> <p>hp = highway paved, yes = 1.0, no = 2.0</p> <p>ms = maximum timetable speed, mph</p> <p>ht = highway type factor value</p> <p>hl = number of highway lanes</p>	<table border="0" style="width: 100%;"> <thead> <tr> <th style="text-align: left;">Highway Type</th> <th style="text-align: left;">Inventory Code</th> <th style="text-align: left;">ht Value</th> </tr> </thead> <tbody> <tr> <td colspan="3" style="text-align: center;"><u>Rural</u></td> </tr> <tr> <td>Interstate</td> <td>01</td> <td>1</td> </tr> <tr> <td>Other principal arterial</td> <td>02</td> <td>2</td> </tr> <tr> <td>Minor arterial</td> <td>06</td> <td>3</td> </tr> <tr> <td>Major collector</td> <td>07</td> <td>4</td> </tr> <tr> <td>Minor collector</td> <td>08</td> <td>5</td> </tr> <tr> <td>Local</td> <td>09</td> <td>6</td> </tr> <tr> <td colspan="3" style="text-align: center;"><u>Urban</u></td> </tr> <tr> <td>Interstate</td> <td>11</td> <td>1</td> </tr> <tr> <td>Other freeway and expressway</td> <td>12</td> <td>2</td> </tr> <tr> <td>Other principal arterial</td> <td>14</td> <td>3</td> </tr> <tr> <td>Minor arterial</td> <td>16</td> <td>4</td> </tr> <tr> <td>Collector</td> <td>17</td> <td>5</td> </tr> <tr> <td>Local</td> <td>19</td> <td>6</td> </tr> </tbody> </table>	Highway Type	Inventory Code	ht Value	<u>Rural</u>			Interstate	01	1	Other principal arterial	02	2	Minor arterial	06	3	Major collector	07	4	Minor collector	08	5	Local	09	6	<u>Urban</u>			Interstate	11	1	Other freeway and expressway	12	2	Other principal arterial	14	3	Minor arterial	16	4	Collector	17	5	Local	19	6
Highway Type	Inventory Code	ht Value																																												
<u>Rural</u>																																														
Interstate	01	1																																												
Other principal arterial	02	2																																												
Minor arterial	06	3																																												
Major collector	07	4																																												
Minor collector	08	5																																												
Local	09	6																																												
<u>Urban</u>																																														
Interstate	11	1																																												
Other freeway and expressway	12	2																																												
Other principal arterial	14	3																																												
Minor arterial	16	4																																												
Collector	17	5																																												
Local	19	6																																												

Source: Railroad-Highway Grade Crossing Handbook, Second Edition. Washington, DC: U.S. Department of Transportation, Federal Highway Administration, 1986.

traffic control device categories are found in Tables 17, 18, and 19, respectively.

The final collision prediction formula can be expressed as follows:

$$B = \frac{T_0}{T_0 + T} (a) + \frac{T_0}{T_0 + T} \left(\frac{N}{T} \right) \quad (2)$$

where:

- B = second collision prediction, collisions per year at the crossing
- a = initial collision prediction from basic formula, collisions per year at the crossing
- $\frac{N}{T}$ = collision history prediction, collisions per year, where N is the number of observed collisions in T years at the crossing

Values for the second collision prediction, B; for different values of the initial prediction, a; and different prior collision rates, $\frac{N}{T}$, are tabularized in Table 20,

21, 22, 23, and 24. Each table represents results for a specific number of years for which collision history data are available. If the number of years of collision data, T, is a fraction, the second collision prediction, B, can be interpolated from the tables or determined directly from the formula.

The formula provides the most accurate results if all the collision history available is used; however, the extent of improvement is minimal if data for more than five years are used. Collision history information older than five years may be misleading because of changes that occur to crossing characteristics over time. If a significant change has occurred to a crossing during the most recent five years, such as the installation of signals, only the collision data since that change should be used.

The final collision prediction, A, is developed by applying a normalizing constant to keep the procedure matched with current collision trends. The final formula, using constants established for 2003, is shown on page 60. (As of November 2003, these new

Table 17. U.S. DOT Accident Prediction Factor Values for Crossings with Passive Warning Devices

K	"c" x "t"	EI	Main	MT	Day	DT	Highway	HP	Maximum	MS	Highway	HT	Highway	HL
					Thru		Paved		Timetable		Type		Lanes	
	0*	1.00	0	1.00	0	1.00	1 (yes)	1.00	0	1.00	01&11	1.00	1	1.00
	1 - 5	2.22	1	1.23	1	1.27	2 (no)	0.54	5	1.04	02&12	0.90	2	1.00
	6 - 10	3.30	2	1.52	2	1.38			10	1.08	06&14	0.82	3	1.00
	11 - 20	4.24	3	1.87	3	1.45			15	1.12	07&16	0.74	4	1.00
	21 - 30	5.01	4	2.31	4	1.50			20	1.17	08&17	0.67	5	1.00
	31 - 50	5.86	5	2.85	5	1.55			25	1.21	09&19	0.61	6	1.00
	51 - 80	6.89	6	3.51	6	1.58			30	1.26			7	1.00
	81 - 120	7.95			7	1.61			35	1.31			8	1.00
	121 - 200	9.29			8	1.64			40	1.36			9	1.00
	201 - 300	10.78			9	1.67			45	1.41				
	301 - 400	12.06			10	1.69			50	1.47				
	401 - 500	13.11			11-20	1.78			55	1.53				
	501 - 600	14.02			21-30	1.91			60	1.59				
	601 - 700	14.82			31-40	2.00			65	1.65				
	701 - 1000	16.21			41-60	2.09			70	1.71				
	1001 - 1300	17.93							75	1.78				
	1301 - 1600	19.37							80	1.85				
	1601 - 2000	20.81							85	1.92				
	2001 - 2500	22.42							90	2.00				
	2501 - 3000	23.97												
	3001 - 4000	25.98												
	4001 - 6000	29.26												
	6001 - 8000	32.73												
	8001 - 10000	35.59												
	10001 - 15000	39.71												
	15001 - 20000	44.43												
	20001 - 25000	48.31												
	25001 - 30000	51.65												
	30001 - 40000	55.98												
	40001 - 50000	60.87												
	50001 - 60000	65.08												
	60001 - 70000	68.81												
	70001 - 90000	73.74												
	90001 -	79.44												
	110001 -	84.42												
	130001 -	91.94												
	150001 -	100.92												
	230001 -	109.94												
	300001 -	118.87												

General Form of Basic Accident Prediction Formula: $a = K \times EI \times MT \times DT \times HP \times HT \times HL$

"c" x "t" = Number of highway vehicles per day, "c", multiplied by total train movements per day, "t"

EI = Exposure index factor
 MT = Main tracks factor
 DT = Day thru trains factor
 HP = Highway paved factor
 MS = Maximum timetable speed factor
 HT = Highway type factor
 HL = Highway lanes factor

* Less than one train per day
 ** See Table 16 for definition of highway type codes

Source: Railroad-Highway Grade Crossing Handbook, Second Edition. Washington, DC: U.S. Department of Transportation, Federal Highway Administration, 1986.

Table 18. U.S. DOT Accident Prediction Factor Values for Crossings with Flashing Light Warning Devices

K	"c" x "t"	EI	Main	MT	Day	DT	Highway	HP	Maximum	MS	Highway	HT	Highway	HL
					Thru		Paved		Timetable		Type		Lanes	
	0*	1.00	0	1.00	0	1.00	1 (yes)	1.00	0	1.00	01&11	1.00	1	1.00
	1 - 5	2.27	1	1.11	1	1.09	2 (no)	1.00	5	1.00	02&12	1.00	2	1.15
	6 - 10	2.99	2	1.24	2	1.12			10	1.00	06&14	1.00	3	1.32
	11 - 20	3.59	3	1.39	3	1.14			15	1.00	07&16	1.00	4	1.51
	21 - 30	4.17	4	1.55	4	1.15			20	1.00	08&17	1.00	5	1.74
	31 - 50	4.79	5	1.72	5	1.17			25	1.00	09&19	1.00	6	1.99
	51 - 80	5.52	6	1.92	6	1.18			30	1.00			7	2.29
	81 - 120	6.27			7	1.18			35	1.00			8	2.63
	121 - 200	7.20			8	1.19			40	1.00			9	3.02
	201 - 300	8.22			9	1.20			45	1.00				
	301 - 400	9.07			10	1.20			50	1.00				
	401 - 500	9.77			11-20	1.23			55	1.00				
	501 - 600	10.37			21-30	1.26			60	1.00				
	601 - 700	10.89			31-40	1.28			65	1.00				
	701 - 1000	11.79			41-60	1.30			70	1.00				
	1001 - 1300	12.89							75	1.00				
	1301 - 1600	13.80							80	1.00				
	1601 - 2000	14.71							85	1.00				
	2001 - 2500	15.72							90	1.00				
	2501 - 3000	16.67												
	3001 - 4000	17.91												
	4001 - 6000	19.89												
	6001 - 8000	21.97												
	8001 - 10000	23.66												
	10001 - 15000	26.08												
	15001 - 20000	28.80												
	20001 - 25000	31.02												
	25001 - 30000	32.91												
	30001 - 40000	35.34												
	40001 - 50000	38.06												
	50001 - 60000	40.39												
	60001 - 70000	42.43												
	70001 - 90000	45.11												
	90001 -	48.18												
	110001 -	50.85												
	130001 -	54.84												
	180001 -	59.56												
	230001 -	64.25												
	300001 -	68.86												

General Form of Basic Accident Prediction Formula: $a = K \times EI \times MT \times DT \times HP \times HT \times HL$

"c" x "t" = Number of highway vehicles per day, "c", multiplied by total train movements per day, "t"

EI = Exposure index factor
 MT = Main tracks factor
 DT = Day thru trains factor
 HP = Highway paved factor
 MS = Maximum timetable speed factor
 HT = Highway type factor
 HL = Highway lanes factor

* Less than one train per day
 ** See Table 16 for definition of highway type codes

Source: Railroad-Highway Grade Crossing Handbook, Second Edition. Washington, DC: U.S. Department of Transportation, Federal Highway Administration, 1986.

Table 19. U.S. DOT Accident Prediction Factor Values for Crossings with Gate Warning Devices

K	"c" x "t"	EI	Main Tracks	MT	Day Thru Trains	DT	Highway Paved	HP	Maximum Timetable Speed	MS	Highway Type Code**	HT	Highway Lanes	HL
	0*	1.00	0	1.00	0	1.00	1 (yes)	1.00	0	1.00	01&11	1.00	1	1.00
	1 - 5	2.37	1	1.34	1	1.00	2 (no)	1.00	5	1.00	02&12	1.00	2	1.11
	6 - 10	3.18	2	1.79	2	1.00			10	1.00	06&14	1.00	3	1.23
	11 - 20	3.86	3	2.40	3	1.00			15	1.00	07&16	1.00	4	1.36
	21 - 30	4.51	4	3.21	4	1.00			20	1.00	08&17	1.00	5	1.51
	31 - 50	5.22	5	4.29	5	1.00			25	1.00	09&19	1.00	6	1.68
	51 - 80	6.07	6	5.74	6	1.00			30	1.00			7	1.86
	81 - 120	6.94			7	1.00			35	1.00			8	2.07
	121 - 200	8.03			8	1.00			40	1.00			9	2.29
	201 - 300	9.23			9	1.00			45	1.00				
	301 - 400	10.25			10	1.00			50	1.00				
	401 - 500	11.08			11-20	1.00			55	1.00				
	501 - 600	11.80			21-30	1.00			60	1.00				
	601 - 700	12.43			31-40	1.00			65	1.00				
	701 - 1000	13.51			41-60	1.00			70	1.00				
	1001 - 1300	14.84							75	1.00				
	1301 - 1600	15.96							80	1.00				
	1601 - 2000	17.07							85	1.00				
	2001 - 2500	18.30							90	1.00				
	2501 - 3000	19.48												
	3001 - 4000	21.00												
	4001 - 6000	23.46												
	6001 - 8000	26.06												
	8001 - 10000	28.18												
	10001 - 15000	31.22												
	15001 - 20000	34.67												
	20001 - 25000	37.49												
	25001 - 30000	39.91												
	30001 - 40000	43.03												
	40001 - 50000	46.53												
	50001 - 60000	49.53												
	60001 - 70000	52.18												
	70001 - 90000	55.67												
	90001 -	59.68												
	110001 -	63.16												
	130001 -	68.41												
	180001 -	74.63												
	230001 -	80.85												
	300001 -	86.98												

General Form of Basic Accident Prediction Formula: $a = K \times EI \times MT \times DT \times HP \times HT \times HL$

"c" x "t" = Number of highway vehicles per day, "c", multiplied by total train movements per day, "t"

EI = Exposure index factor
 MT = Main tracks factor
 DT = Day thru trains factor
 HP = Highway paved factor
 MS = Maximum timetable speed factor
 HT = Highway type factor
 HL = Highway lanes factor

* Less than one train per day
 ** See Table 16 for definition of highway type codes

Source: Railroad-Highway Grade Crossing Handbook, Second Edition. Washington, DC: U.S. Department of Transportation, Federal Highway Administration, 1986.

constants will be in the Personal Computer Accident Prediction System software and an Internet version of the Highway-Rail Crossing Web Accident Prediction System located on the FRA Website.⁵⁶)

- .6500 passive devices
- A = .5001 flashing lights
- .5725 gates

Accident severity. Additional equations within the U.S. DOT model are used to predict the likelihood of fatalities and injuries. The probability of a fatal accident given an accident, P(FA|A), is expressed as:

$$P(FA|A) = \frac{1}{1 + CF \times MS \times TT \times TS \times UR} \quad (3)$$

where:

- CF = formula constant = 695
- MS = factor for maximum timetable train speed
- TT = factor for through trains per day
- TS = factor for switch trains per day
- UR = factor for urban or rural crossing

⁵⁶ Ibid.

Table 20. U.S. DOT Final Accident Prediction from Initial Prediction and Accident History (1 year of accident data (T = 1))

Initial Prediction from Basic Model, a	Number of Accidents, N, in T Years					
	0	1	2	3	4	5
0.00	0.000	0.048	0.095	0.143	0.190	0.238
0.01	0.009	0.066	0.123	0.179	0.236	0.292
0.02	0.019	0.084	0.150	0.215	0.280	0.346
0.03	0.028	0.102	0.176	0.250	0.324	0.398
0.04	0.037	0.119	0.202	0.284	0.367	0.450
0.05	0.045	0.136	0.227	0.318	0.409	0.500
0.06	0.054	0.153	0.252	0.351	0.450	0.550
0.07	0.063	0.170	0.277	0.384	0.491	0.598
0.08	0.071	0.186	0.301	0.416	0.531	0.646
0.09	0.079	0.202	0.325	0.447	0.570	0.693
0.10	0.087	0.217	0.348	0.478	0.609	0.739
0.20	0.160	0.360	0.560	0.760	0.960	1.160
0.30	0.222	0.481	0.741	1.000	1.259	1.519
0.40	0.276	0.586	0.897	1.207	1.517	1.828
0.50	0.323	0.677	1.032	1.387	1.742	2.097
0.60	0.364	0.758	1.152	1.545	1.939	2.333
0.70	0.400	0.829	1.257	1.686	2.114	2.543
0.80	0.432	0.892	1.351	1.811	2.270	2.730
0.90	0.462	0.949	1.436	1.923	2.410	2.897
1.00	0.488	1.000	1.512	2.024	2.537	3.049
1.10	0.512	1.047	1.581	2.116	2.651	3.186
1.20	0.533	1.089	1.644	2.200	2.756	3.311
1.30	0.553	1.128	1.702	2.277	2.851	3.426
1.40	0.571	1.163	1.755	2.347	2.939	3.531
1.50	0.588	1.196	1.804	2.412	3.020	3.627
1.60	0.604	1.226	1.849	2.472	3.094	3.717
1.70	0.618	1.255	1.891	2.527	3.164	3.800
1.80	0.632	1.281	1.930	2.579	3.228	3.877
1.90	0.644	1.305	1.966	2.627	3.288	3.949
2.00	0.656	1.328	2.000	2.672	3.344	4.016
2.10	0.667	1.349	2.032	2.714	3.397	4.079
2.20	0.677	1.369	2.062	2.754	3.446	4.138
2.30	0.687	1.388	2.090	2.791	3.493	4.194
2.40	0.696	1.406	2.116	2.826	3.536	4.246
2.50	0.704	1.423	2.141	2.859	3.577	4.296

Source: Railroad-Highway Grade Crossing Handbook, Second Edition. Washington, DC: U.S. Department of Transportation, Federal Highway Administration, 1986.

Table 21. U.S. DOT Final Accident Prediction from Initial Prediction and Accident History (2 years of accident data (T = 2))

Initial Prediction from Basic Model, a	Number of Accidents, N, in T Years								
	0	1	2	3	4	5	6	7	8
0.00	0.000	0.045	0.091	0.136	0.182	0.227	0.273	0.318	0.364
0.01	0.009	0.063	0.116	0.170	0.223	0.277	0.330	0.384	0.438
0.02	0.018	0.079	0.140	0.202	0.263	0.325	0.386	0.447	0.509
0.03	0.026	0.095	0.164	0.233	0.302	0.371	0.440	0.509	0.578
0.04	0.034	0.110	0.186	0.263	0.339	0.415	0.492	0.568	0.644
0.05	0.042	0.125	0.208	0.292	0.375	0.458	0.542	0.625	0.708
0.06	0.049	0.139	0.230	0.320	0.410	0.500	0.590	0.680	0.770
0.07	0.056	0.153	0.250	0.347	0.444	0.540	0.637	0.734	0.831
0.08	0.063	0.167	0.270	0.373	0.476	0.579	0.683	0.786	0.889
0.09	0.070	0.180	0.289	0.398	0.508	0.617	0.727	0.836	0.945
0.10	0.077	0.192	0.308	0.423	0.538	0.654	0.769	0.885	1.000
0.20	0.133	0.300	0.467	0.633	0.800	0.967	1.133	1.300	1.467
0.30	0.176	0.382	0.588	0.794	1.000	1.206	1.412	1.618	1.824
0.40	0.211	0.447	0.684	0.921	1.158	1.395	1.632	1.868	2.105
0.50	0.238	0.500	0.762	1.024	1.286	1.548	1.810	2.071	2.333
0.60	0.261	0.543	0.826	1.109	1.391	1.674	1.957	2.239	2.522
0.70	0.280	0.580	0.880	1.180	1.480	1.780	2.080	2.380	2.680
0.80	0.296	0.611	0.926	1.241	1.556	1.870	2.185	2.500	2.815
0.90	0.310	0.638	0.966	1.293	1.621	1.948	2.276	2.603	2.931
1.00	0.323	0.661	1.000	1.339	1.677	2.016	2.355	2.694	3.032
1.10	0.333	0.682	1.030	1.379	1.727	2.076	2.424	2.773	3.121
1.20	0.343	0.700	1.057	1.414	1.771	2.129	2.486	2.843	3.200
1.30	0.351	0.716	1.081	1.446	1.811	2.176	2.541	2.905	3.270
1.40	0.359	0.731	1.103	1.474	1.846	2.218	2.590	2.962	3.333
1.50	0.366	0.744	1.122	1.500	1.878	2.256	2.634	3.012	3.390
1.60	0.372	0.756	1.140	1.523	1.907	2.291	2.674	3.058	3.442
1.70	0.378	0.767	1.156	1.544	1.933	2.322	2.711	3.100	3.489
1.80	0.383	0.777	1.170	1.564	1.957	2.351	2.745	3.138	3.532
1.90	0.388	0.786	1.184	1.582	1.980	2.378	2.776	3.173	3.571
2.00	0.392	0.794	1.196	1.598	2.000	2.402	2.804	3.206	3.608
2.10	0.396	0.802	1.208	1.613	2.019	2.425	2.830	3.236	3.642
2.20	0.400	0.809	1.218	1.627	2.036	2.445	2.855	3.264	3.673
2.30	0.404	0.816	1.228	1.640	2.053	2.465	2.877	3.289	3.702
2.40	0.407	0.822	1.237	1.653	2.068	2.483	2.898	3.314	3.729
2.50	0.410	0.828	1.246	1.664	2.082	2.500	2.918	3.336	3.754

Source: Railroad-Highway Grade Crossing Handbook, Second Edition. Washington, DC: U.S. Department of Transportation, Federal Highway Administration, 1986.

Table 22. U.S. DOT Final Accident Prediction from Initial Prediction and Accident History (3 years of accident data (T = 3))

Initial Prediction from Basic Model, a	Number of Accidents, N, in T Years												
	0	1	2	3	4	5	6	7	8	9	10	11	12
0.00	0.000	0.043	0.087	0.130	0.174	0.217	0.261	0.304	0.348	0.391	0.435	0.478	0.522
0.01	0.008	0.059	0.110	0.161	0.212	0.263	0.314	0.364	0.415	0.466	0.517	0.568	0.619
0.02	0.017	0.074	0.132	0.190	0.248	0.306	0.364	0.421	0.479	0.537	0.595	0.653	0.711
0.03	0.024	0.089	0.153	0.218	0.282	0.347	0.411	0.476	0.540	0.605	0.669	0.734	0.798
0.04	0.031	0.102	0.173	0.244	0.315	0.386	0.457	0.528	0.598	0.669	0.740	0.811	0.882
0.05	0.038	0.115	0.192	0.269	0.346	0.423	0.500	0.577	0.654	0.731	0.808	0.885	0.962
0.06	0.045	0.128	0.211	0.293	0.376	0.459	0.541	0.624	0.707	0.789	0.872	0.955	1.038
0.07	0.051	0.140	0.228	0.316	0.404	0.493	0.581	0.669	0.757	0.846	0.934	1.022	1.110
0.08	0.058	0.151	0.245	0.338	0.432	0.525	0.619	0.712	0.806	0.899	0.993	1.086	1.180
0.09	0.063	0.162	0.261	0.359	0.458	0.556	0.655	0.754	0.852	0.951	1.049	1.148	1.246
0.10	0.069	0.172	0.276	0.379	0.483	0.586	0.690	0.793	0.897	1.000	1.103	1.207	1.310
0.20	0.114	0.257	0.400	0.543	0.686	0.829	0.971	1.114	1.257	1.400	1.543	1.686	1.829
0.30	0.146	0.317	0.488	0.659	0.829	1.000	1.171	1.341	1.512	1.683	1.854	2.024	2.195
0.40	0.170	0.362	0.553	0.745	0.936	1.128	1.319	1.511	1.702	1.894	2.085	2.277	2.468
0.50	0.189	0.396	0.604	0.811	1.019	1.226	1.434	1.642	1.849	2.057	2.264	2.472	2.679
0.60	0.203	0.424	0.644	0.864	1.085	1.305	1.525	1.746	1.966	2.186	2.407	2.627	2.847
0.70	0.215	0.446	0.677	0.908	1.138	1.369	1.600	1.831	2.062	2.292	2.523	2.754	2.985
0.80	0.225	0.465	0.701	0.944	1.183	1.423	1.662	1.901	2.141	2.380	2.620	2.859	3.099
0.90	0.234	0.481	0.727	0.974	1.221	1.468	1.714	1.961	2.208	2.455	2.701	2.948	3.195
1.00	0.241	0.494	0.747	1.000	1.253	1.506	1.759	2.012	2.265	2.518	2.771	3.024	3.277
1.10	0.247	0.506	0.764	1.022	1.281	1.539	1.798	2.056	2.315	2.573	2.831	3.090	3.348
1.20	0.253	0.516	0.779	1.042	1.305	1.568	1.832	2.095	2.358	2.621	2.884	3.147	3.411
1.30	0.257	0.525	0.792	1.059	1.327	1.594	1.861	2.129	2.396	2.663	2.931	3.198	3.465
1.40	0.262	0.533	0.804	1.075	1.346	1.617	1.888	2.159	2.430	2.701	2.972	3.243	3.514
1.50	0.265	0.540	0.814	1.088	1.363	1.637	1.912	2.186	2.460	2.735	3.009	3.283	3.558
1.60	0.269	0.546	0.824	1.101	1.378	1.655	1.933	2.210	2.487	2.765	3.042	3.319	3.597
1.70	0.272	0.552	0.832	1.112	1.392	1.672	1.952	2.232	2.512	2.792	3.072	3.352	3.632
1.80	0.275	0.557	0.840	1.122	1.405	1.687	1.969	2.252	2.534	2.817	3.099	3.382	3.664
1.90	0.271	0.562	0.847	1.131	1.416	1.701	1.985	2.270	2.555	2.839	3.124	3.409	3.693
2.00	0.280	0.566	0.853	1.140	1.427	1.713	2.000	2.287	2.573	2.860	3.147	3.434	3.720
2.10	0.282	0.570	0.859	1.148	1.436	1.725	2.013	2.302	2.591	2.879	3.168	3.456	3.745
2.20	0.284	0.574	0.865	1.155	1.445	1.735	2.026	2.316	2.606	2.897	3.187	3.477	3.768
2.30	0.286	0.578	0.870	1.161	1.453	1.745	2.037	2.329	2.621	2.913	3.205	3.497	3.789
2.40	0.287	0.581	0.874	1.168	1.461	1.754	2.048	2.341	2.635	2.928	3.222	3.515	3.808
2.50	0.289	0.584	0.879	1.173	1.468	1.763	2.058	2.353	2.647	2.942	3.237	3.532	3.827

Source: Railroad-Highway Grade Crossing Handbook, Second Edition. Washington, DC: U.S. Department of Transportation, Federal Highway Administration, 1986.

**Table 23. U.S. DOT Final Accident Prediction from Initial Prediction and Accident History
(4 years of accident data (T = 4))**

Initial Prediction from Basic Model, a	Number of Accidents, N, in T Years														
	0	1	2	3	4	5	6	7	8	9	10	11	12	13	14
0.00	0.000	0.042	0.083	0.125	0.167	0.208	0.250	0.292	0.333	0.375	0.417	0.458	0.500	0.542	0.583
0.01	0.008	0.056	0.105	0.135	0.202	0.250	0.298	0.347	0.395	0.444	0.492	0.540	0.589	0.637	0.685
0.02	0.016	0.070	0.125	0.180	0.234	0.289	0.344	0.398	0.453	0.508	0.563	0.617	0.672	0.727	0.781
0.03	0.023	0.083	0.144	0.205	0.265	0.326	0.386	0.447	0.500	0.568	0.629	0.689	0.750	0.811	0.871
0.04	0.029	0.096	0.162	0.228	0.294	0.360	0.426	0.493	0.559	0.625	0.691	0.757	0.824	0.890	0.956
0.05	0.036	0.107	0.179	0.250	0.321	0.393	0.464	0.536	0.607	0.679	0.750	0.821	0.893	0.964	1.036
0.06	0.042	0.118	0.194	0.271	0.347	0.424	0.500	0.576	0.653	0.729	0.806	0.882	0.958	1.035	1.111
0.07	0.047	0.128	0.209	0.291	0.372	0.453	0.534	0.615	0.696	0.777	0.858	0.939	1.020	1.101	1.182
0.08	0.053	0.138	0.224	0.309	0.395	0.480	0.566	0.651	0.737	0.822	0.908	0.993	1.079	1.164	1.250
0.09	0.058	0.147	0.237	0.327	0.417	0.506	0.596	0.686	0.776	0.865	0.955	1.045	1.135	1.224	1.314
0.10	0.062	0.156	0.250	0.344	0.438	0.531	0.625	0.719	0.812	0.906	1.000	1.094	1.188	1.281	1.375
0.20	0.100	0.225	0.350	0.475	0.600	0.726	0.850	0.975	1.100	1.225	1.350	1.475	1.600	1.725	1.850
0.30	0.125	0.271	0.417	0.563	0.708	0.854	1.000	1.146	1.292	1.437	1.583	1.729	1.875	2.021	2.167
0.40	0.143	0.304	0.464	0.625	0.786	0.946	1.107	1.268	1.429	1.589	1.750	1.911	2.071	2.232	2.393
0.50	0.156	0.328	0.500	0.672	0.844	1.016	1.188	1.359	1.531	1.703	1.875	2.047	2.219	2.391	2.563
0.60	0.167	0.347	0.528	0.708	0.889	1.069	1.250	1.431	1.611	1.792	1.972	2.153	2.333	2.514	2.694
0.70	0.175	0.363	0.550	0.738	0.925	1.113	1.300	1.488	1.675	1.863	2.050	2.238	2.425	2.613	2.800
0.80	0.182	0.375	0.568	0.761	0.955	1.148	1.341	1.534	1.727	1.920	2.114	2.307	2.500	2.693	2.886
0.90	0.188	0.385	0.583	0.781	0.979	1.177	1.375	1.573	1.771	1.969	2.167	2.365	2.563	2.760	2.958
1.00	0.192	0.394	0.596	0.798	1.000	1.202	1.404	1.606	1.808	2.010	2.212	2.413	2.615	2.817	3.019
1.10	0.196	0.402	0.607	0.813	1.018	1.223	1.429	1.634	1.839	2.045	2.250	2.455	2.661	2.866	3.071
1.20	0.200	0.408	0.617	0.825	1.033	1.242	1.450	1.658	1.867	2.075	2.283	2.492	2.700	2.908	3.117
1.30	0.203	0.414	0.625	0.836	1.047	1.258	1.469	1.680	1.891	2.102	2.313	2.523	2.734	2.945	3.156
1.40	0.206	0.419	0.632	0.846	1.059	1.272	1.485	1.699	1.912	2.125	2.338	2.551	2.765	2.978	3.191
1.50	0.208	0.424	0.639	0.854	1.069	1.285	1.500	1.715	1.931	2.146	2.361	2.576	2.792	3.007	3.222
1.60	0.211	0.428	0.645	0.862	1.079	1.296	1.513	1.730	1.947	2.164	2.382	2.599	2.816	3.033	3.250
1.70	0.213	0.431	0.650	0.869	1.088	1.306	1.525	1.744	1.962	2.181	2.400	2.619	2.837	3.056	3.275
1.80	0.214	0.433	0.655	0.875	1.095	1.315	1.536	1.756	1.976	2.196	2.417	2.637	2.857	3.077	3.293
1.90	0.216	0.437	0.659	0.881	1.102	1.324	1.545	1.767	1.989	2.210	2.432	2.653	2.875	3.097	3.318
2.00	0.217	0.440	0.663	0.886	1.109	1.332	1.554	1.777	2.000	2.223	2.446	2.668	2.891	3.114	3.337
2.10	0.219	0.443	0.667	0.891	1.115	1.339	1.562	1.786	2.010	2.234	2.458	2.682	2.906	3.130	3.354
2.20	0.220	0.445	0.670	0.895	1.120	1.345	1.570	1.795	2.020	2.245	2.470	2.695	2.920	3.145	3.370
2.30	0.221	0.447	0.673	0.899	1.125	1.351	1.577	1.803	2.029	2.255	2.481	2.707	2.933	3.159	3.385
2.40	0.222	0.449	0.676	0.903	1.130	1.356	1.583	1.810	2.037	2.264	2.491	2.718	2.944	3.171	3.398
2.50	0.223	0.451	0.679	0.906	1.134	1.362	1.589	1.817	2.045	2.272	2.500	2.728	2.955	3.183	3.411

Source: Railroad-Highway Grade Crossing Handbook, Second Edition. Washington, DC: U.S. Department of Transportation, Federal Highway Administration, 1986.

**Table 24. U.S. DOT Final Accident Prediction from Initial Prediction and Accident History
(5 years of accident data (T = 5))**

Initial Prediction from Basic Model, a	Number of Accidents, N, in T Years														
	0	1	2	3	4	5	6	7	8	9	10	11	12	13	14
0.00	0.000	0.040	0.080	0.120	0.160	0.200	0.240	0.280	0.320	0.360	0.400	0.440	0.480	0.560	0.600
0.01	0.008	0.054	0.100	0.146	0.192	0.238	0.285	0.331	0.377	0.423	0.469	0.515	0.562	0.654	0.702
0.02	0.015	0.067	0.119	0.170	0.222	0.274	0.326	0.378	0.430	0.481	0.533	0.585	0.637	0.741	0.795
0.03	0.021	0.079	0.136	0.193	0.250	0.307	0.364	0.421	0.479	0.536	0.593	0.650	0.707	0.821	0.877
0.04	0.028	0.090	0.152	0.214	0.276	0.338	0.400	0.462	0.524	0.586	0.648	0.710	0.772	0.897	0.954
0.05	0.033	0.100	0.167	0.233	0.300	0.367	0.433	0.500	0.567	0.633	0.700	0.767	0.833	0.967	1.024
0.06	0.039	0.110	0.181	0.252	0.323	0.394	0.465	0.535	0.606	0.677	0.748	0.819	0.890	1.032	1.090
0.07	0.044	0.119	0.194	0.269	0.344	0.419	0.494	0.569	0.644	0.719	0.794	0.869	0.944	1.094	1.152
0.08	0.048	0.127	0.206	0.285	0.364	0.442	0.521	0.600	0.679	0.758	0.836	0.915	0.994	1.152	1.210
0.09	0.053	0.135	0.218	0.300	0.382	0.465	0.547	0.629	0.712	0.794	0.876	0.959	1.041	1.206	1.264
0.10	0.057	0.143	0.229	0.314	0.400	0.486	0.571	0.657	0.743	0.829	0.914	1.000	1.086	1.257	1.315
0.20	0.089	0.200	0.311	0.422	0.533	0.644	0.756	0.867	0.978	1.089	1.200	1.311	1.422	1.644	1.702
0.30	0.109	0.236	0.364	0.491	0.618	0.745	0.873	1.000	1.127	1.255	1.382	1.509	1.636	1.891	1.949
0.40	0.123	0.262	0.400	0.538	0.677	0.815	0.954	1.092	1.231	1.369	1.508	1.646	1.785	2.062	2.120
0.50	0.133	0.280	0.427	0.573	0.720	0.867	1.013	1.160	1.307	1.453	1.600	1.747	1.893	2.187	2.245
0.60	0.141	0.294	0.447	0.600	0.753	0.906	1.059	1.212	1.365	1.518	1.671	1.824	1.976	2.282	2.340
0.70	0.147	0.305	0.463	0.621	0.779	0.937	1.095	1.253	1.411	1.568	1.726	1.884	2.042	2.358	2.416
0.80	0.152	0.314	0.476	0.638	0.800	0.962	1.124	1.286	1.448	1.610	1.771	1.933	2.095	2.419	2.477
0.90	0.157	0.322	0.487	0.652	0.817	0.983	1.148	1.313	1.478	1.643	1.809	1.974	2.139	2.470	2.528
1.00	0.160	0.328	0.496	0.664	0.832	1.000	1.168	1.336	1.504	1.672	1.840	2.008	2.176	2.512	2.570
1.10	0.163	0.333	0.504	0.674	0.844	1.015	1.185	1.356	1.526	1.696	1.867	2.037	2.207	2.548	2.606
1.20	0.166	0.338	0.510	0.683	0.855	1.028	1.200	1.372	1.545	1.717	1.890	2.062	2.234	2.579	2.637
1.30	0.168	0.342	0.516	0.690	0.865	1.039	1.213	1.387	1.561	1.735	1.910	2.084	2.258	2.606	2.664
1.40	0.170	0.345	0.521	0.697	0.873	1.048	1.224	1.400	1.576	1.752	1.927	2.103	2.279	2.630	2.688
1.50	0.171	0.349	0.526	0.703	0.880	1.057	1.234	1.411	1.589	1.766	1.943	2.120	2.297	2.651	2.709
1.60	0.173	0.351	0.530	0.708	0.886	1.065	1.243	1.422	1.600	1.779	1.957	2.135	2.314	2.670	2.728
1.70	0.174	0.354	0.533	0.713	0.892	1.072	1.251	1.431	1.610	1.790	1.969	2.149	2.328	2.687	2.745
1.80	0.176	0.356	0.537	0.717	0.898	1.078	1.259	1.439	1.620	1.800	1.980	2.161	2.341	2.702	2.760
1.90	0.177	0.358	0.540	0.721	0.902	1.084	1.265	1.447	1.628	1.809	1.991	2.172	2.353	2.716	2.774
2.00	0.178	0.360	0.542	0.724	0.907	1.089	1.271	1.453	1.636	1.818	2.000	2.182	2.364	2.729	2.787
2.10	0.179	0.362	0.545	0.728	0.911	1.094	1.277	1.460	1.643	1.826	2.009	2.191	2.374	2.740	2.798
2.20	0.180	0.363	0.547	0.731	0.914	1.098	1.282	1.465	1.649	1.833	2.016	2.200	2.384	2.751	2.809
2.30	0.180	0.365	0.549	0.733	0.918	1.102	1.286	1.471	1.655	1.839	2.024	2.208	2.392	2.761	2.819
2.40	0.181	0.366	0.551	0.736	0.921	1.106	1.291	1.475	1.660	1.845	2.030	2.215	2.400	2.770	2.829
2.50	0.182	0.367	0.553	0.738	0.924	1.109	1.295	1.480	1.665	1.851	2.036	2.222	2.407	2.778	2.838

Source: Railroad-Highway Grade Crossing Handbook, Second Edition. Washington, DC: U.S. Department of Transportation, Federal Highway Administration, 1986.

The probability of an injury accident given an accident is:

$$P(\text{IA} | \text{A}) = \frac{1 - P(\text{FA} | \text{A})}{1 + \text{CI} \times \text{MS} \times \text{TK} \times \text{UR}} \quad (4)$$

where:

$P(\text{FA} | \text{A})$ = probability of a fatal accident, given an accident

CI = formula constant = 4.280

MS = factor for maximum timetable train speed

TK = factor for number of tracks

UR = factor for urban or rural crossing

The equations for calculating values of the factors are listed in Table 25 for the fatal accident probability formula and Table 26 for the injury accident probability formula. To simplify use of the formulae, the values of the factors have been tabulated for typical values of crossing characteristics and are given in Tables 27 and 28 for the fatal accident and injury accident probability formulae, respectively.

Table 25. Equations for Crossing Characteristic Factors for U.S. DOT Fatal Accident Probability Formula

Fatal Accident Probability Formula:

$$P(\text{FA} | \text{A}) = \frac{1}{(1 + \text{CF} \times \text{MS} \times \text{TT} \times \text{TS} \times \text{UR})}$$

Crossing Characteristic Factor	Equation for Crossing Characteristic Factor
Formula constant	CF = 695
Maximum timetable train speed factor	MS = $ms^{-1.074}$
Thru trains per day	TT = $(tt + 1)^{-0.1025}$
Switch train per day factor	TS = $(ts + 1)^{0.1025}$
Urban-Rural crossing factor	UR = $e^{0.1880ur}$

where: ms = maximum timetable train speed, mph
 tt = number of thru trains per day
 ts = number of switch trains per day
 ur = 1, urban crossing
 = 0, rural crossing

Source: Railroad-Highway Grade Crossing Handbook, Second Edition. Washington, DC: U.S. Department of Transportation, Federal Highway Administration, 1986.

Table 26. Equations for Crossing Characteristic Factors for U.S. DOT Injury Accident Probability Formula

Injury Accident Probability Formula:

$$P(\text{IA} | \text{A}) = \frac{1 - P(\text{FA} | \text{A})}{(1 + \text{CI} \times \text{MS} \times \text{TK} \times \text{UR})}$$

Crossing Characteristic Factor	Equation for Crossing Characteristic Factor
Fatal accident probability	$P(\text{FA} \text{A})$ - See Table 25
Formula constant	CI = 4.280
Maximum timetable train speed factor	MS = $ma^{-0.2334}$
Number of tracks factor	TK = $e^{0.1176tk}$
Urban-Rural crossing factor	UR = $e^{0.1844ur}$

where: ms = maximum timetable train speed, mph
 tk = total number of tracks at crossing
 ur = 1, urban crossing
 = 0, rural crossing

Source: Railroad-Highway Grade Crossing Handbook, Second Edition. Washington, DC: U.S. Department of Transportation, Federal Highway Administration, 1986.

Table 27. Factor Values for U.S. DOT Fatal Accident Probability Formula

Fatal Accident Probability Formula:

$$P(\text{FA} | \text{A}) = \frac{1}{(1 + \text{CF} \times \text{MS} \times \text{TT} \times \text{TS} \times \text{UR})}$$

where: CF = 695.0, formula constant
 UR = 1.207, urban crossing
 = 1.000, rural crossing, and

Maximum Timetable Train Speed	MS	Thru Trains Per Day	TT	Switch Trains Per Day	TS
1	1.000	0	1.000	0	1.000
5	0.178	1	0.931	1	1.074
10	0.084	2	0.894	2	1.119
15	0.055	3	0.868	3	1.152
20	0.040	4	0.848	4	1.179
25	0.032	5	0.832	5	1.202
30	0.026	6	0.819	6	2.221
40	0.019	7	0.808	7	1.238
50	0.015	9	0.790	9	1.266
60	0.012	10	0.782	10	1.279
70	0.010	20	0.732	20	1.366
80	0.009	30	0.703	30	1.422
90	0.008	40	0.683	40	1.464
100	0.007	50	0.668	50	1.497

Source: Railroad-Highway Grade Crossing Handbook, Second Edition. Washington, DC: U.S. Department of Transportation, Federal Highway Administration, 1986.

Table 28. Factor Values for U.S. DOT Injury Accident Probability Formula

Injury Accident Probability Formula:

$$P(IA | A) = \frac{1 - P(FA | A)}{(1 + CI \times MS \times TK \times UR)}$$

where: P(FA|A) = Fatal accident probability, See Tables 25 and 27
 CI = 4.280, formula constant
 UR = 1.202, urban crossing
 = 1.000, rural crossing, and

Maximum Timetable Train Speed	MS	Total Number Of Tracks	TK
1	1.000	0	1.000
5	0.687	1	1.125
10	0.584	2	1.265
15	0.531	3	1.423
20	0.497	5	1.800
25	0.472	6	2.025
30	0.452	7	2.278
40	0.423	8	2.562
50	0.401	9	2.882
60	0.385	10	3.241
70	0.371	15	5.836
80	0.360	20	10.507
90	0.350		
100	0.341		

Source: Railroad-Highway Grade Crossing Handbook, Second Edition. Washington, DC: U.S. Department of Transportation, Federal Highway Administration, 1986.

C. Engineering Study*

Federal requirements dictate that each state shall establish priorities for its crossing program based on:

- The potential reduction in collisions or collision severities.
- The project costs and available resources.
- The relative hazard of each crossing based on a hazard index formula.
- An on-site inspection of each candidate crossing.
- The potential danger to large numbers of people at crossings used on a regular basis by passenger trains or buses or by trains or motor vehicles carrying hazardous materials.
- Other criteria as deemed appropriate by each state.⁵⁷

* Includes previously unpublished materials provided by Ray Lewis, West Virginia Department of Transportation, 2006.

⁵⁷ "Railroad Crossing Corridor Improvements." Washington, DC: U.S. Department of Transportation (U.S. DOT), Federal Highway Administration (FHWA), Demonstration Projects Division, June 1986.

Engineering studies should be conducted of highway-rail crossings that have been selected from the priority list. The purpose of these studies is to:

- Review the crossing and its environment.
- Identify the nature of any problems.
- Recommend alternative improvements.

An engineering study consists of a review of site characteristics, the existing traffic control system, and highway and railroad operational characteristics. Based on a review of these conditions, an assessment of existing and potential hazards can be made. If safety deficiencies are identified, countermeasures can be recommended.

1. Diagnostic Team Study Method

The procedure recommended in earlier editions of this handbook, adopted in FHWA's *Highway Safety Engineering Study Procedural Guide*,⁵⁸ and adopted in concept by several states is the diagnostic team study approach. This term is used to describe a simple survey procedure utilizing experienced individuals from several sources. The procedure involves the diagnostic team's evaluation of the crossing as to its deficiencies and judgmental consensus as to the recommended improvements.

The primary factors to be considered when assigning people to the diagnostic team are that the team is interdisciplinary and representative of all groups having responsibility for the safe operation of crossings so that each of the vital factors relating to the operational and physical characteristics of the crossing may be properly identified. Individual team members are selected on the basis of their specific expertise and experience. The overall structure of the team is built upon three desired areas of responsibility:

- Local responsibility.
- Administrative responsibility.
- Advisory capability.

For the purpose of the diagnostic team, the operational and physical characteristics of crossings can be classified into three areas:

Traffic operations. This area includes both vehicular and train traffic operation. The responsibilities of highway traffic engineers and railroad operating personnel chosen for team membership include, among

⁵⁸ *Highway Safety Engineering Studies Procedural Guide*. Washington, DC: U.S. DOT, FHWA, November 1991.

other criteria, specific knowledge of highway and railroad safety, types of vehicles and trains, and their volumes and speeds.

Traffic control devices. Highway maintenance engineers, signal control engineers, and railroad signal engineers provide the best source for expertise in this area. Responsibilities of these team members include knowledge of active traffic control systems, interconnection with adjacent signalized highway intersections, traffic control devices for vehicle operations in general and at crossings, and crossing signs and pavement markings.

Administration. It is necessary to realize that many of the problems relating to crossing safety involve the apportionment of administrative and financial responsibility. This should be reflected in the membership of the diagnostic team. The primary responsibility of these members is to advise the team of specific policy and administrative rules applicable to the modification of crossing traffic control devices.

To ensure appropriate representation on the diagnostic team, it is suggested that the team comprise at least a traffic engineer with safety experience and a railroad signal engineer. Following are other disciplines that might be represented on the diagnostic team:

- Railroad administrative official.
- Highway administrative official.
- Human factors engineer.
- Law enforcement officer.
- Regulatory agency official.
- Railroad operating official.

The diagnostic team should study all available data and inspect the crossing and its surroundings with the objective of determining the conditions that affect safety and traffic operations. In conducting the study, a questionnaire is recommended to provide a structured account of the crossing characteristics and their effect on safety. Some states are now using automated diagnostic review forms to facilitate the collection, storage, and analysis of crossing data. Example forms developed and used by various states are reproduced in Appendix G. Figure 6 shows a sample questionnaire, which can be altered to fit individual agency needs. The questionnaire shown in Figure 6 is divided into four sections:

- Distant approach and advance warning.
- Immediate highway approach.
- Crossing proper.
- Summary and analysis.

To conduct the diagnostic team field study, traffic cones are placed on the approaches, as shown in Figure 7.

Crossing approach zone. Cone A is placed at the point where the driver first obtains information that there is a crossing ahead. This distance is also the beginning of the approach zone. Usually, this information comes from the advance warning sign, the pavement markings, or the crossing itself. The distance from the crossing is based on the decision sight distance, which is the distance required for a driver to detect a crossing and to formulate actions needed to avoid colliding with trains.

Tables 29 and 30 provide a range of distances from point A to the crossing stop line, dependent upon design vehicle speeds. The maximum distances are applicable to crossings with a high level of complexity and will generally be applicable on urban roads and streets. These distances correspond to the decision sight distances for stops on rural roads and for stops on urban roads in the American Association of State Highway and Transportation Officials (AASHTO) “Green Book.” In calculating sight distances, the height of the driver’s eye is considered 1.080 meter (3.5 feet) above the roadway surface for passenger vehicles; the target height is considered 0.6 meter (2.0 feet) above the roadway surface.⁵⁹

Table 29. Distances in Meters to Establish Study Positions for Diagnostic Team Evaluation

Design vehicle speed (kilometers per hour)	Distance from stop line* to cone A (meters)	Distance from stop line* to cone B (meters)
50	155	70
60	195	95
70	235	115
80	280	140
90	325	170
100	370	200
110	420	235
120	470	265

* Note: The distance from the stop line is assumed to be 4.5 meters from nearest rail, or 2.4 meters from the gate if one is present.

Source: From A Policy on Geometric Design of Highway and Streets, 2004, by the American Association of State Highway and Transportation Officials, Washington, DC. Used by permission.

⁵⁹ A Policy on Geometric Design of Highways and Streets, 2004 Edition. Washington, DC: American Association of State Highway and Transportation Officials, 2004.

Figure 6. Sample Questionnaire for Diagnostic Team Evaluation

LOCATIONAL DATA: Street Name: _____ City: _____
Railroad: _____ Crossing Number: _____
VEHICLE DATA: No. of Approach Lanes: _____ Approach Speed Limit: _____ AADT: _____
Approach Curvature: _____ Approach Gradient: _____
TRAIN DATA: No. of Tracks: _____ Train Speed Limit: _____ Trains Per Day: _____
Track Gradients: _____

SECTION I—Distance Approach and Advance Warning

1. Is advance warning of railroad crossing available? _____ If so, what devices are used? _____
2. Do advance warning devices alert drivers to the presence of the crossing and allow time to react to approaching train traffic?
3. Do approach grades, roadway curvature, or obstructions limit the view of advance warning devices? ___ If so, how?
4. Are advance warning devices readable under night, rainy, snowy, or foggy conditions? _____

SECTION II—Immediate Highway Approach

1. What maximum safe approach speed will existing sight distance support? _____
2. Is that speed equal to or above the speed limit on that part of the highway? _____
3. If not, what has been done, or reasonably could be done, to bring this to the driver's attention? _____
4. What restrictive obstructions to sight distance might be removed? _____
5. Do approach grades or roadway curvature restrict the driver's view of the crossing? _____
6. Are railroad crossing signals or other active warning devices operating properly and visible to adequately warn drivers of approaching trains? _____

SECTION III—Crossing Proper

1. From a vehicle stopped at the crossing, is the sight distance down the track to an approaching train adequate for the driver to cross the tracks safely? _____
2. Are nearby intersection traffic signals or other control device affecting the crossing operation?
If so, how? _____
3. Is the stopping area at the crossing adequately marked? _____
4. Do vehicles required by law to stop at all crossings present a hazard at the crossing? _____ Why? _____
5. Do conditions at the crossing contribute to, or are they conducive to, a vehicle stalling at or on the crossing?
6. Are nearby signs, crossing signals, etc. adequately protected to minimize hazards to approaching traffic? _____
7. Is the crossing surface satisfactory? _____ If not, how and why? _____
8. Is surface of highway approaches satisfactor? _____ If not, why?

SECTION IV—Summary and Analysis

1. List major attributes of the crossing which may contribute to safety. _____
2. List features which reduce crossing safety. _____
3. Possible methods for improving safety at the crossing: _____
4. Overall evaluation of crossing: _____
5. Other comments: _____

Source: Railroad-Highway Grade Crossing Handbook, Second Edition. Washington, DC: U.S. Department of Transportation, Federal Highway Administration, 1986.

Figure 7. Study Positions for Diagnostic Team

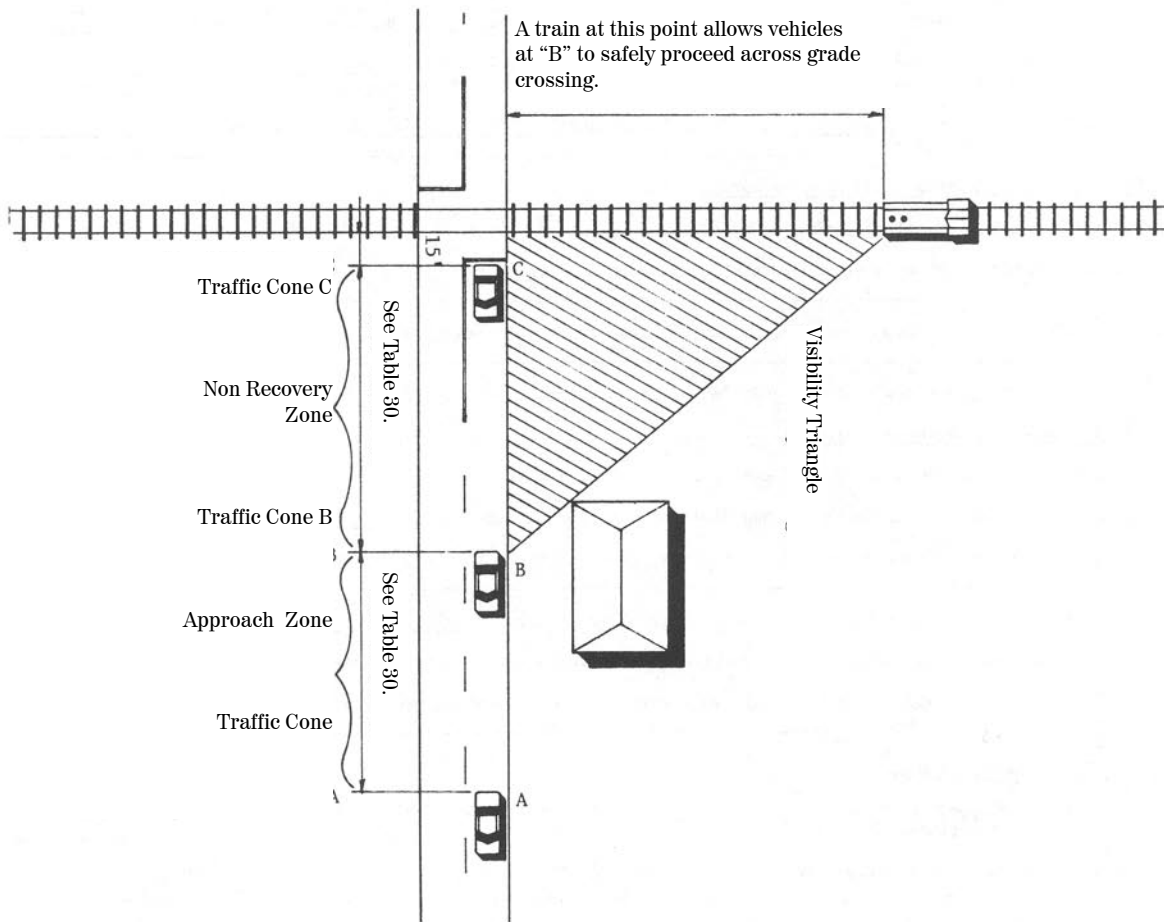

Source: Railroad-Highway Grade Crossing Handbook, Second Edition. Washington, DC: U.S. Department of Transportation, Federal Highway Administration, 1986.

Table 30. Distances in Feet to Establish Study Positions for Diagnostic Team Evaluation

Design vehicle speed (miles per hour)	Distance from stop line* to cone A (feet)	Distance from stop line* to cone B (feet)
30	490	220
40	690	330
50	910	465
55	1030	535
60	1150	610
70	1410	780

* Note: The distance from the stop line is assumed to be 15 feet from nearest rail, or 8 feet from the gate if one is present.

Source: From A Policy on Geometric Design of Highway and Streets, 2004, by the American Association of State Highway and Transportation Officials, Washington, DC. Used by permission.

Safe stopping point. Cone B is placed at the point where the approaching driver must be able to see an approaching train so that a safe stop can be made if necessary. This point is located at the end of the approach zone and the end of the non-recovery zone. Distances to point B are based on the design vehicle speed and are also shown in Tables 29 and 30. These distances are stopping sight distances to the stop line and are in accordance with the upper end of the range of stopping sight distances in the AASHTO "Green Book."⁶⁰ In calculating these distances, a level approach is assumed. If this is not the case, an allowance must be made for the effects of positive or negative approach grades.

⁶⁰ Ibid.

Stop line. Cone C is placed at the stop line, which is assumed to be 4.6 meters (15 feet) from the near rail of the crossing, or 8 feet from the gate if one is present.

The questions in Section I of the questionnaire (refer to Figure 6) are concerned with the following:

- Driver awareness of the crossing.
- Visibility of the crossing.
- Effectiveness of advance warning signs and signals.
- Geometric features of the highway.

When responding to questions in this section, the crossing should be observed from the beginning of the approach zone, at traffic cone A.

The questions in Section II (refer to Figure 6) are concerned with whether the driver has sufficient information to detect an approaching train and make correct decisions about crossing safely. Observations for responding to questions in this section should be made from cone B. Factors considered by these questions include the following:

- Driver awareness of approaching trains.
- Driver dependence on crossing signals.
- Obstruction of view of train's approach.
- Roadway geometrics diverting driver attention.
- Potential location of standing railroad cars.
- Possibility of removal of sight obstructions.
- Availability of information for stop or go decision by the driver.

The questions in Section III (refer to Figure 6) apply to observations adjacent to the crossing, at cone C. Of particular concern, especially when the driver must stop, is the ability to see down the tracks for approaching trains. Intersecting streets and driveways should also be observed to determine whether intersecting traffic could affect the operation of highway vehicles over the crossing. Questions in this section relate to the following:

- Sight distance down the tracks.
- Pavement markings.
- Conditions conducive to vehicles becoming stalled or stopped on the crossing.

- Operation of vehicles required by law to stop at the crossing.
- Signs and signals as fixed object hazards.
- Opportunity for evasive action by the driver.

Corner sight distance.⁶¹ Available sight distances help determine the safe speed at which a vehicle can approach a crossing. The following three sight distances should be considered:

- Distance ahead to the crossing.
- Distance to and along the tracks on which a train might be approaching the crossing from either direction.
- Sight distance along the tracks in either direction from a vehicle stopped at the crossing.

These sight distances are illustrated in Figure 8.

In the first case, the distance ahead to the crossing, the driver must determine whether a train is occupying the crossing or whether there is an active traffic control device indicating the approach or presence of a train. In such an event, the vehicle must be stopped short of the crossing, and the available sight distance may be a determining factor limiting the speed of an approaching vehicle.

The relationship between vehicle speed and this sight distance is set forth in the following formula:

$$d_H = AV_v t + \frac{BV_v^2}{a} + D + d_e \tag{5}$$

where,

- d_H = sight distance measured along the highway from the nearest rail to the driver of a vehicle, which allows the vehicle to be safely stopped without encroachment of the crossing area, feet
- A = constant = 1.47
- B = constant = 1.075
- V_v = velocity of the vehicle, miles per hour (mph)
- t = perception-reaction time, seconds, assumed to be 2.5 seconds
- a = driver deceleration, assumed to be 11.2 feet per second²
- D = distance from the stop line or front of vehicle to the near rail, assumed to be 15 feet
- d_e = distance from the driver to the front of the vehicle, assumed to be 8 feet

⁶¹ Ibid.

This formula is also expressed in SI Metric terms, as follows:

$$d_H = AV_v t + \frac{BV_v^2}{a} + D + d_e \quad (6)$$

where:

- d_H = sight distance measured along the highway from the nearest rail to the driver of a vehicle, which allows the vehicle to be safely stopped without encroachment of the crossing area, feet
- A = constant = 0.278
- B = constant = 0.039
- V_v = velocity of the vehicle, kilometers per hour (km/hr.)
- t = perception-reaction time, seconds, assumed to be 2.5 seconds
- a = driver deceleration, assumed to be 3.4 meters per second²
- D = distance from the stop line or front of vehicle to the near rail, assumed to be 4.5 meters
- d_e = distance from the driver to the front of the vehicle, assumed to be 2.4 meters

The minimum safe sight distances, d_H , along the highway for selected vehicle speeds are shown in the bottom line of Tables 31 and 32. As noted, these distances were calculated for certain assumed conditions and should be increased for less favorable conditions.

The second sight distance utilizes a so-called “sight triangle” in the quadrants on the vehicle approach side of the track. This triangle is formed by:

- The distance (d_H) of the vehicle driver from the track.
- The distance (d_T) of the train from the crossing.
- The unobstructed sight line from the driver to the front of the train.

This sight triangle is depicted in Figure 8. The relationships between vehicle speed, maximum timetable train speed, distance along the highway (d_H), and distance along the railroad are set forth in the following formula:

$$d_T = \frac{V_T}{V_v} (A)V_v t + \frac{BV_v^2}{a} + 2D + L + W \quad (7)$$

Figure 8. Crossing Sight Distances

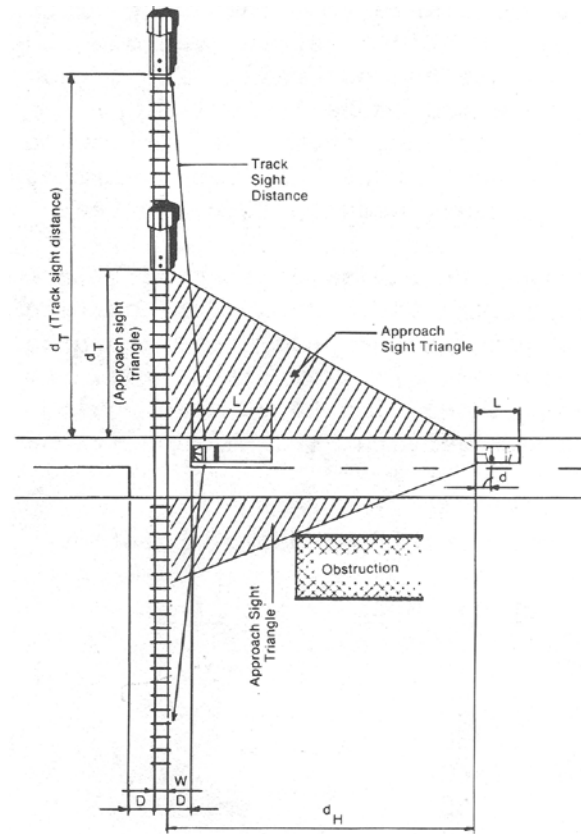

Source: Railroad-Highway Grade Crossing Handbook, Second Edition. Washington, DC: U.S. Department of Transportation, Federal Highway Administration, 1986.

where:

- d_T = sight distance along the railroad tracks to permit the vehicle to cross and be clear of the crossing upon arrival of the train
- A = constant = 1.47
- B = constant = 1.075
- V_v = velocity of the vehicle, mph
- t = perception-reaction time, seconds, assumed to be 2.5 seconds
- a = driver deceleration, assumed to be 11.2 feet per second²
- D = distance from the stop line or front of vehicle to the near rail, assumed to be 15 feet
- L = length of vehicle, assumed to be 65 feet
- W = distance between outer rails (for a single track, this value is 5 feet)

In SI Metric values, this formula becomes:

$$d_T = \frac{V_T}{V_v} (A)V_v t + \frac{BV_v^2}{a} + 2D + L + W \tag{8}$$

where:

- d_T = sight distance along the railroad tracks to permit the vehicle to cross and be clear of the crossing upon arrival of the train
- A = constant = 0.278
- B = constant = 0.039
- V_v = velocity of the vehicle, km/hr.
- t = perception-reaction time, seconds, assumed to be 2.5 seconds
- a = driver deceleration, assumed to be 3.4 meters per second²
- D = distance from the stop line or front of vehicle to the near rail, assumed to be 4.5 meters
- L = length of vehicle, assumed to be 20 meters
- W = distance between outer rails (for a single track, this value is 1.5 meters)

Distances d_h and d_T are shown in Tables 31 and 32 for several selected highway speeds and train speeds.

Clearing sight distance. In the case of a vehicle stopped at a crossing, the driver needs to see both ways along the track to determine whether a train is approaching and to estimate its speed. The driver needs to have a sight distance along the tracks that will permit sufficient time to accelerate and clear the crossing prior to the arrival of a train, even though the train might come into view as the vehicle is beginning its departure process.

Figure 9 illustrates the maneuver. These sight distances, for a range of train speeds, are given in the column for a vehicle speed of zero in Tables 31 and 32. These values are obtained from the following formula:

$$d_T = 1.47V_T \left(\frac{V_G}{a_1} + \frac{L + 2D + W - d}{V_G} + J \right) \tag{9}$$

where:

- V_G = maximum speed of vehicle in selected starting gear, assumed to be 8.8 feet per second
- a_1 = acceleration of vehicle in starting gear, assumed to be 1.47 feet per second per second
- J = sum of the perception time and the time required to activate the clutch or an automatic shift, assumed to be 2 seconds
- d_a = distance the vehicle travels while accelerating to maximum speed in first gear, or

$$d_a = \frac{V_G^2}{2a_1} \text{ or } \frac{8.8^2}{(2)(1.47)} = 26.4 \text{ feet} \tag{10}$$

d_T , V_T , L, D, and W are defined as above.

Expressing the formula again in SI Metric terms:

$$d_T = 0.28V_T \left(\frac{V_G}{a_1} + \frac{L + 2D + W - d_a}{V_G} + J \right) \tag{11}$$

where:

- V_G = maximum speed of vehicle in selected starting gear, assumed to be 2.7 meters per second
- a_1 = acceleration of vehicle in starting gear, assumed to be 0.45 meter per second per second
- J = sum of the perception time and the time required to activate the clutch or an automatic shift, assumed to be 2 seconds
- d_a = distance the vehicle travels while accelerating to maximum speed in first gear, or

$$d_a = \frac{V_G^2}{2a_1}$$

$$\frac{2.7^2}{(2)(0.45)} = 8.1 \text{ meters}$$

d_T , V_T , L, D, and W are defined as above.⁶²

Figure 9. Sight Distance for a Vehicle Stopped at Crossing

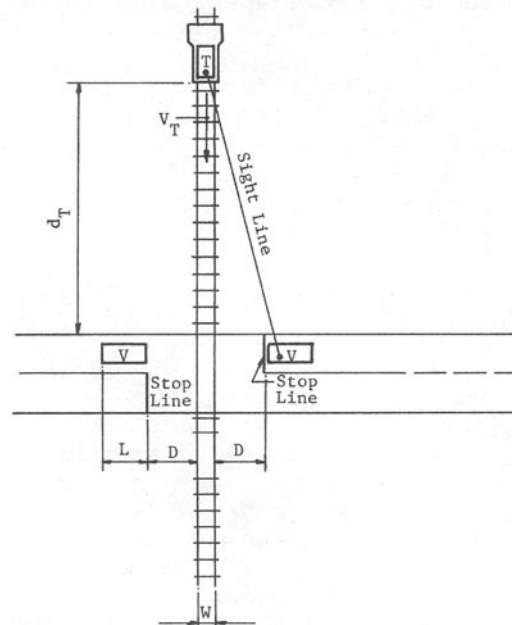

Source: Railroad-Highway Grade Crossing Handbook, Second Edition. Washington, DC: U.S. Department of Transportation, Federal Highway Administration, 1986.

Table 31. Sight Distances for Combinations of Highway Vehicle and Train Speeds, Metric

	Case B: Departure from stop	Case A: Moving vehicle												
	Vehicle speed (km/hr.)													
Train speed (km/hr.)	0	10	20	30	40	50	60	70	80	90	100	110	120	130
	Distance along railroad from crossing, d_r (feet)													
10	45	39	24	21	19	19	19	19	20	21	21	22	23	24
20	91	77	49	41	38	38	38	39	40	41	43	45	47	48
30	136	116	73	62	57	56	57	58	60	62	64	67	70	73
40	181	154	98	82	77	75	76	77	80	83	86	89	93	97
50	227	193	122	103	96	94	95	97	100	103	107	112	116	121
60	272	232	147	123	115	113	113	116	120	124	129	134	140	145
70	317	270	171	144	134	131	132	135	140	145	150	156	163	169
80	362	309	196	164	153	150	151	155	160	165	172	179	186	194
90	408	347	220	185	172	169	170	174	179	186	193	201	209	218
100	453	386	245	206	192	188	189	193	199	207	215	223	233	242
110	498	425	269	226	211	207	208	213	219	227	236	246	256	266
120	544	463	294	247	230	225	227	232	239	248	258	268	279	290
130	589	502	318	267	249	244	246	251	259	269	279	290	302	315
140	634	540	343	288	268	263	265	271	279	289	301	313	326	339
	Distance along highway from crossing, d_H (feet)													
		15	25	38	53	70	90	112	136	162	191	222	255	291

Source: From A Policy on Geometric Design of Highway and Streets, 2004, by the American Association of State Highway and Transportation Officials, Washington, DC. Used by permission.

Table 32. Sight Distances for Combinations of Highway Vehicle and Train Speeds, U.S. Customary

	Case B: Departure from stop	Case A: Moving vehicle							
	Vehicle speed (mph)								
Train speed (mph)	0	10	20	30	40	50	60	70	80
	Distance along railroad from crossing, d_r (feet)								
10	240	146	106	99	100	105	111	118	126
20	480	293	212	198	200	209	222	236	252
30	721	439	318	297	300	314	333	355	378
40	961	585	424	396	401	419	444	473	504
50	1201	732	530	494	501	524	555	591	630
60	1441	878	636	593	601	628	666	709	756
70	1681	1024	742	692	701	733	777	828	882
80	1921	1171	848	791	801	833	888	946	1008
90	2162	1317	954	890	901	943	999	1064	1134
	Distance along highway from crossing, d_H (feet)								
		69	135	220	324	447	589	751	931

Source: From A Policy on Geometric Design of Highway and Streets, 2004, by the American Association of State Highway and Transportation Officials, Washington, DC. Used by permission.

Adjustments for longer vehicle lengths, slower acceleration capabilities, multiple tracks, skewed crossings, and other than flat highway grades are necessary. The formulas in this section may be used with proper adjustments to the appropriate dimensional values. It would be desirable that sight distances permit operation at the legal approach speed for highways. This is often impractical.

In Section IV of the questionnaire, the diagnostic team is given the opportunity to do the following:

- List major features that contribute to safety.
- List features that reduce crossing safety.
- Suggest methods for improving safety at the crossing.
- Give an overall evaluation of the crossing.
- Provide comments and suggestions relative to the questionnaire.

In addition to completing the questionnaire, team members should take photographs of the crossing from both the highway and the railroad approaches.

Current and projected vehicle and train operation data should be obtained from the team members. Information on the use of the crossing by buses, school buses, trucks transporting hazardous materials, and passenger trains should be provided. The evaluation of the crossing should include a thorough evaluation of collision frequency, collision types, and collision circumstances. Both train-vehicle collisions and vehicle-vehicle collisions should be examined.

Team members should drive each approach several times to become familiar with all conditions that exist at or near the crossing. All traffic control devices (signs, signals, markings, and train detection circuits) should be examined as part of this evaluation. If the crossing is equipped with signals, the railroad signal engineer should activate them so that their alignment and light intensity may be observed.

The *Manual on Uniform Traffic Control Devices* (MUTCD) should be a principal reference for this evaluation.⁶³ Also, *A User's Guide to Positive Guidance* provides information for conducting evaluations of traffic control devices.⁶⁴

⁶³ *Manual on Uniform Traffic Control Devices, 2003 Edition*. Washington, DC: FHWA, 2003.

⁶⁴ *A User's Guide to Positive Guidance*. Washington, DC, U.S. DOT, FHWA, Office of Operations, June 1977.

After the questionnaire has been completed, the team is reassembled for a short critique and discussion period. Each member should summarize his or her observations pertaining to safety and operations at the crossing. Possible improvements to the crossing may include the following:

- Closing of crossing—available alternate routes for highway traffic.
- Site improvements—removal of obstructions in the sight triangle, highway realignment, improved cross section, drainage, or illumination.
- Crossing surfaces—rehabilitation of the highway structure, the track structure, or both; installation of drainage and subgrade filter fabric; adjustments to highway approaches; and removal of retired tracks from the crossing.
- Traffic control devices—installation of passive or active control devices and improvement of train detection equipment.

The results and recommendations of the diagnostic team should be documented. Recommendations should be presented promptly to programming and implementation authorities.

Both government and railroad resources are becoming more limited. The *Highway Safety Engineering Studies Procedural Guide* suggests crossing evaluation by an individual, in lieu of the diagnostic team.⁶⁵ The guide suggests that this individual be a traffic engineer with experience in highway-rail crossing and traffic safety. A background in signal control and safety program administration would also be advantageous.

2. Traffic Conflict Technique

Highway traffic collisions are a statistically rare event. Typically, an engineer or analyst must assemble several years of collision data to have a large enough sample to identify a pattern of collisions and suggest countermeasures. The traffic conflict technique was developed during the early 1970s by Research Laboratories, General Motors Corporation, to be a measure of traffic collision potential.

A traffic conflict occurs when a driver takes evasive action, brakes, or weaves to avoid a collision. The conflict is evidenced by a brake-light indication or a lane change by the offended driver. Procedures have

⁶⁵ *Highway Safety Engineering Studies Procedural Guide*. Washington, DC: U.S. DOT, FHWA, November 1991.

been developed to define and record traffic conflicts to permit the performance of formal surveys.⁶⁶

Originally, traffic conflict surveys had to be carried out by a team of observers in the field. The availability of inexpensive and reliable video equipment permits photographic data collection in the field, followed by more accurate and complete data analysis in the office.

3. Collision Study

Vehicle-train collisions are very infrequent at most crossings. Based on 1995 data, the average public crossing would experience a train-involved collision every 56.3 years.⁶⁷ As a result, traditional collision analyses techniques are usually of limited utility.

Collision studies may be needed under the following circumstances:

- Some high-exposure crossings may experience sufficient collisions that a pattern can be established.
- It may be necessary to do an in-depth investigation of an individual collision, either as part of a safety evaluation or in preparation for litigation. See Chapter XIII for more information.
- NTSB frequently carries out in-depth studies of certain collisions or of a number of collisions that fit a certain category. NTSB's findings and recommendations may be useful at the individual crossing level or as input to a grade crossing improvement program.
- Traditional collision study methods may be applicable to vehicle-vehicle collisions that are associated with the physical characteristics or the operation of a highway-rail grade crossing.

4. Traffic Study

Important considerations when studying traffic flow and operations at a highway-rail grade crossing are traffic volumes (daily and peak hour); speeds; the mix of vehicle types; intersecting volumes and turning movements at intersections near the crossing; the capacity of the road; delays; and the formation of any traffic queues. These should be reviewed in light of current conditions and how they might be affected by changes at the crossing.

Particular concerns are routing and access for emergency vehicles and the use of the crossing by special vehicles such as low clearance vehicles, buses, and trucks transporting hazardous materials.

If a crossing consolidation is contemplated, the effects on traffic circulation and the impact on the operation of adjacent intersections should be considered. Frequently, the consolidation of crossings also leads to the consolidation of traffic on other facilities and may permit the construction of a traffic signal at a nearby intersection or other improvements that could not be justified otherwise.

The traffic study should also consider the impacts of crossing operations on the community. Considerations include frequency and length of train operations, pedestrian and bicycle access, and the need for crossings to provide adequate access to schools and services.

Standard data collection procedures can be found in several sources, including the *Highway Safety Engineering Studies Procedural Guide* or the *Manual of Transportation Engineering Studies* from the Institute of Transportation Engineers.^{68, 69}

5. Near-Hit Reports

Some railroads operate a program under which train crews report "near hits" with or violations by highway vehicles at crossings. These reports can be a valuable source of information regarding problem crossings and will also contain data regarding vehicle ownerships and types, time of day, and other contributing factors.

Where the vehicle can be positively identified, the reports are frequently turned over to the property protection department of the railroad (railroad police) for follow-up. This is particularly true in the case of documented violations by drivers for commercial carriers or for transit and school bus operators.

6. Enforcement Study

An enforcement study is directed at providing an objective measurement of the frequency of violations of traffic control devices and traffic laws. Hidden observers or cameras are used to observe the location or condition under study. Data collected will include total traffic volume, total vehicles encountering the situation under study, and total observed violations.

⁶⁶ Perkins, Stuart R. *GMR Traffic Conflicts Technique Procedures Manual*. Research Laboratories, General Motors Corporation, Warren, Michigan, August 11, 1969.

⁶⁷ *Railroad Safety Statistics 2004 Annual Report*. Washington, DC: U.S. DOT, FRA, November 2005.

⁶⁸ *Highway Safety Engineering Studies Procedural Guide*. Washington, DC: U.S. DOT, FHWA, November 1991.

⁶⁹ *Manual of Transportation Engineering Studies*. Washington, DC: Institute of Transportation Engineers, 1994.

The enforcement study must be carried out so that traffic operations and driver behavior are not affected. If an actual law enforcement officer or police car appears on the scene, the study should be interrupted or terminated. The measurements obtained may be used as a basis for later enforcement campaigns and may also be used to justify improvements in traffic control devices, such as the installation of constant warning time devices to improve the credibility of crossing signals.

Various types of specialized photographic equipment are available for conducting enforcement studies or for actual photographic enforcement of traffic laws. Photographic enforcement has been used successfully at grade crossings and along at least one light-rail transit corridor.⁷⁰

D. Systems Approach

The procedures for evaluating highway-rail grade crossings are generally based upon the physical and operational characteristics of individual crossings. A typical crossing safety program consists of a number of individual crossing projects. Funding for crossing safety is approved on the basis of the requirements of these individual projects. Therefore, crossing evaluation, programming, and construction follow traditional highway project implementation procedures.

The concept of using the systems approach to highway-rail grade crossing improvements was enhanced when crossings off the federal-aid system were made eligible for federally funded programs. Because all public crossings are now eligible for improvement with federal funds, the systems approach provides a comprehensive method for addressing safety and operations at crossings.

The systems approach considers the highway-rail grade crossing a part or a component of a larger transportation system. For this purpose, the transportation system is defined as a land surface system consisting of both highway and railroad facilities. The intersection of these two transportation modes affects both safety and operations of the entire system. The objective of the systems approach for crossings is to improve both safety and operations of the total system or segments of the system.

The systems approach may be applied to a segment of the rail component of the system. For example, to improve operating efficiency and safety over a specified segment of a rail line, all crossings would be considered in the evaluation. Thus, the systems approach is often called the corridor approach.

The systems approach may be applied to an urban area, city, or community. In this case, all public crossings within the jurisdiction of a public agency are evaluated and programmed for improvements. The desired outcome is a combination of engineering improvements and closures such that both safety and operations are highly improved.

Assume that a segment of rail line is to be upgraded for unit train operations or high-speed passenger service. This type of change in rail operations would provide an ideal opportunity for the application of the systems approach. The rail line may be upgraded by track and signal improvements for train operations that might cause a need for adjustments in train detection circuits of active traffic control devices. Also, modifications of train operations and speeds may require the installation of active traffic control devices at selected crossings.

A systems approach developed for crossings in a specified community or political subdivision allows for a comprehensive analysis of highway traffic operations. Thus, unnecessary crossings can be closed, and improvements can be made at other crossings. This approach enhances the acceptability of crossing closures by local officials and citizens.

Initially, all crossings in the system, both public and private, should be identified and classified by jurisdictional responsibility (for example, city, county, and state for public crossings; parties to the agreement for private crossings). Information should be gathered on highway traffic patterns, train operations, emergency access needs, land uses, and growth trends. Inventory records for the crossings should be updated to reflect current operational and physical characteristics. A diagnostic team consisting of representatives from all public agencies having jurisdiction over the identified crossings and the railroads operating over the crossings should make an on-site assessment of each crossing as described in the previous section. The diagnostic team's recommendations should consider, among other things, crossing closure, installation of active traffic control devices, upgrading existing active devices, elimination by grade separation, surface improvements, and improvements in train detection circuits. In addition, modification of train operations near and at each

⁷⁰ *Photographic Enforcement of Traffic Laws*. Washington, DC: National Cooperative Highway Research Program Synthesis of Practice 219, 1995.

crossing, removal of sight obstructions, rerouting of special vehicles and emergency vehicles, and railroad relocation should be considered.

Federal, state, and local crossing funding programs should be reviewed to identify the eligibility of each crossing improvement for public funding. Other funding sources include railroads, urban renewal funds, land development funds, and other public or private funding sources.

There are several advantages of the systems approach. A group of crossings may be improved more efficiently through the procurement of materials and equipment in quantity, thus reducing product procurement and transportation costs. Usually, only one agreement between the state, local jurisdiction, and railroad is necessary for all of the improvements. Train detection circuits may be designed as a part of the total railroad signal system rather than custom designed for each individual crossing. Electronic components, relay houses, and signal transmission equipment may be more efficiently utilized. Labor costs may be significantly reduced. Travel time of construction crews may be reduced when projects are in close proximity to each other.

Railroads benefit from the application of the systems approach in several ways. Train speeds may be increased due to safety improvements at crossings. Maintenance costs may be reduced if a sufficient number of crossings are closed. Other improvements may enhance the efficiency of rail operations.

Safety improvements are an obvious benefit to the public. Other benefits include reduced vehicular delays and better access for emergency vehicles.

One impediment to the systems approach is that most federal and state crossing safety improvement programs provide funding for safety improvements only. Also, safety improvement projects may be limited to crossings that rank high on a priority schedule. Another impediment is the involvement of multiple jurisdictions.

FHWA has endorsed the systems approach and its resultant identification of low-cost improvements to crossing safety and operations. FHWA sponsored a demonstration project that utilized the systems approach to improve crossings along a rail corridor in Illinois. To eliminate the need for project agreements with each local agency, the Illinois Commerce Commission issued a single order covering the work to be performed at nine locations. This accelerated the project and reduced labor-intensive work. FHWA and

the Illinois Department of Transportation agreed that minimal plan submittals would be required of local agencies, and local agencies agreed to perform the necessary work at mutually agreed-upon lump sum prices under the supervision of Illinois Department of Transportation district representatives.

Improvements made as part of the demonstration project in Illinois included the following:

- Removal of vegetation.
- Pavement widening.
- Reconstruction of approaches.
- Installation of 12-inch lenses in crossing signals.
- Relocation of train loading areas.
- Closure of crossings.
- Removal of switch track.
- Installation of traffic control signs pertinent to crossing geometries.

The Florida Department of Transportation and other states have adopted policies incorporating the systems approach as part of their crossing safety improvement programs. The Florida Department of Transportation selects track segments on the basis of the following conditions:

- Abnormally high percentage of crossings with passive traffic control devices only.
- Freight trains carrying hazardous material in an environment that presents an unacceptable risk of a catastrophic event.
- Passenger train routes.
- Plans for increased rail traffic, especially commuter trains.

The North Carolina Department of Transportation (NCDOT) has used the systems approach often in recent years. Examples of these projects are the Sealed Corridor Program and traffic separation studies.

In the Sealed Corridor Program, NCDOT installed devices such as four-quadrant gates, longer gate arms, median separators, and new signs and pavement markings at every public crossing along the entire railway line between Charlotte and Greensboro, North Carolina. The program is planned to eventually cover the entire corridor between Charlotte and Raleigh, North Carolina. The entire corridor contains 172 public and 43 private railroad crossings.

In traffic separation studies, the NCDOT Rail Division works with communities to study how best to separate railroad and highway traffic. Engineers develop a

comprehensive traffic separation study to determine which public crossings need improvements and which need to be closed. During the study phase, the engineering consultant collects traffic data for the public rail crossings in the study area. The consultants also take into account the economic impact of the potential closings.

A draft of the consultants' recommendations is submitted to the Rail Division and the public for review and comment. The recommendations are prioritized to include near-term, mid-term, and long-term improvements. Public hearings are scheduled in each community to give residents a chance to voice opinions about the proposed recommendations. The forums also allow NCDOT to discuss the benefits of enhanced crossing safety.

In the implementation phase, NCDOT officials identify funding for the proposed enhancements (typically, 90 percent is federal funds with a 10-percent local match). The freight railroads sometimes provide additional resources.

Additional information on these and other NCDOT programs can be found on the NCDOT Safety Initiatives Website.⁷¹

E. References

Box, Paul C. and J.C. Oppenlander. *Manual of Traffic Engineering Studies*. Washington, DC: Institute of Transportation Engineers, 1976.

Code of Federal Regulations, Title 49, Washington, DC: Government Printing Office, published annually.

Farr, E.H. and J.S. Ritz. *Accident Severity Prediction Formula for Rail-Highway Crossings*. Washington, DC: Federal Highway Administration (FHWA), Federal Railroad Administration (FRA), Report FHWA-RD-83/092, July 1983.

Federal-Aid Policy Guide. Washington, DC: FHWA, updated periodically.

Federal Highway Administration Survey of Region and Division Offices, unpublished, 1984.

Goodell-Grivas, Inc. *Highway Safety Engineering Studies: Procedural Guide*. Washington, DC: FHWA, FHWA-TS-81220, June 1981.

Hitz, John and Mary Cross. *Rail-Highway Crossing Resource Allocation Procedure User's Guide*. Washington, DC: FHWA and FRA, Report FHWA-IP-82-7, December 1982.

Manual on Uniform Traffic Control Devices, 2003 Edition. Washington, DC: FHWA, 2003.

A Policy on Geometric Design of Highway and Streets. Washington, DC: American Association of State Highway and Transportation Officials, 1984.

Post, T.J., G.J. Alexander, and H. Lunenfeld. *A User's Guide to Positive Guidance, Second Edition*. Washington, DC: FHWA, Report FHWA-TO-81-1, December 1981.

Railroad/Highway Grade Crossing Accidents Involving Trucks Transporting Bulk Hazardous Materials, A Special Study. Washington, DC: National Transportation Safety Board, Report NTSB-RZM-81-2, September 1981.

Schoppert, David W. and Dan W. Hoyt. *Factors Influencing Safety at Highway-Rail Grade Crossings*. Washington, DC: Highway Research Board, National Cooperative Highway Research Program Report 50, 1968.

Traffic Control Devices Handbook. Washington, DC: FHWA, 1983.

Update Manual: National Railroad Highway Crossing Inventory. Washington, DC: U.S. Department of Transportation, 1976.

⁷¹ North Carolina Department of Transportation Safety Initiatives Website (www.bytrain.org/Safety/default.html).

Identification of Alternatives

IV

Previous chapters presented methodologies for selecting and analyzing potentially hazardous highway-rail grade crossings. In this chapter, existing laws, rules, regulations, and policies are presented and alternative safety and operational improvements are discussed. These alternatives are presented by type: crossing elimination; installation of passive traffic control devices; installation of active traffic control devices; site improvements; crossing surface improvements; and removal of grade separations. From information contained in this chapter, the highway engineer should select several alternative improvement proposals for any particular crossing being studied. The “do-nothing” alternative should also be considered a proposal. Procedures for selecting among the various alternatives are presented in Chapter V, Selection of Alternatives.

A. Existing Laws, Rules, Regulations, and Policies

Current Federal Highway Administration (FHWA) regulations specifically prohibit at-grade intersections on highways with full access control (23 CFR Section 625 (4)). Federal Railroad Administration (FRA) rail safety regulations require that crossings be separated or closed where trains operate at speeds above 125 miles per hour (mph) (49 CFR 213.347(a)). Additionally, if train operation is projected at FRA track class 7 (111–125 mph), an application must be made to FRA for approval of the type of warning/barrier system. The regulation does not specify the type of system but allows the petitioner to propose a suitable system for FRA review.

In 1998, FRA issued an Order of Particular Applicability for high-speed rail service on the Northeast Corridor. In the order, FRA set a maximum operating speed of 80 mph over any highway-rail

crossing where only conventional warning systems are in place and a maximum operating speed of 95 mph where four-quadrant gates and presence detection are provided and tied into the signal system. Grade crossings are prohibited on the Northeast Corridor if maximum operating speeds exceed 95 mph. Current statutory, regulatory, and federal policy requirements are summarized in Table 33.

Table 33. Federal Laws, Rules, Regulations, and Policies

	Active	Warning/ barrier with FRA approval	Grade separate or close
Controlled access highways	Not allowed	Not allowed	Required
High-speed rail	> 79 mph	111–125 mph	> 125 mph

* Note: 1 mph = 1.61 kilometers per hour

Source: Guidance on Traffic Control Devices at Highway-Rail Grade Crossings. Washington, DC: Federal Highway Administration, Highway/Rail Grade Crossing Technical Working Group, November 2002.

Not unlike the system specification that all highway-rail crossings on full control access highways be grade separated, it is only logical that certain rail systems should have similar status. In 1994, FRA defined a core railroad system of approximately 128,800 kilometers (80,000 miles) known as Principal Railroad Lines (PRLs). These lines have one or more of the following attributes: Amtrak service, defense essential, or annual freight volume exceeding 20 million gross tons. This core network was described in the U.S. Department of Transportation’s (U.S. DOT) 1994 Action Plan to improve highway-rail grade crossing safety. The plan set forth a long-term goal of eliminating (grade separating

or realigning) intersections of PRLs and highway routes on the National Highway System—defined as “an interconnected system of principal arterial routes to serve major population centers, intermodal transportation facilities and other major travel destinations; meet national defense requirements; and serve interstate and interregional travel.”⁷²

B. Elimination

The first alternative that should always be considered for a highway-rail at-grade crossing is elimination. Elimination can be accomplished by grade separating the crossing, closing the crossing to highway traffic, or closing the crossing to railroad traffic through the abandonment or relocation of the rail line. Elimination of a crossing provides the highest level of crossing safety because the point of intersection between highway and railroad is removed. However, the effects of elimination on highway and railroad operations may be beneficial or adverse. The benefits of the elimination alternative are primarily safety and, perhaps, operational—offset by construction and operational costs.

Decisions regarding whether the crossing should be eliminated or otherwise improved through the installation of traffic control devices or site or surface improvements depend upon safety, operational, and cost considerations. However, the Federal-Aid Policy Guide (FAPG) does specify that “all crossings of railroads and highways at grade shall be eliminated where there is full control of access on the highway (a freeway) regardless of the volume of railroad or highway traffic.”⁷³

The major benefits of crossing elimination include reductions in collisions, highway vehicle delay, rail traffic delay, and maintenance costs of crossing surfaces and traffic control devices.

Safety considerations include both train-involved collisions and non-train-involved collisions. Under the Federal Motor Carrier Safety regulations, all vehicles transporting passengers and trucks carrying many types of hazardous materials must stop prior to crossing tracks at a highway-rail grade crossing (49 CFR 392.10). In the event that following vehicles do not anticipate such stops and/or fail to maintain safe stopping distance, collisions may result. These conditions may be alleviated to some extent where the

vehicles required to stop have a special lane at the crossing for such purpose. In addition, the presence of the crossing itself may cause non-train collisions. For example, when stopping suddenly to avoid a collision with an oncoming train, a driver may lose control of the vehicle and collide with a roadside object. Thus, these types of collisions would be avoided if an at-grade crossing were eliminated.

Four types of delay are imposed on highway traffic by crossings:

- **Trains occupying crossings**—Highway traffic should slow down to look for trains, particularly at crossings with passive traffic control devices. Vehicles must stop and wait for a train to clear a crossing. Furthermore, there may be some delay to vehicles that arrive at a crossing before vehicles that were delayed by a train have cleared the crossing.
- **Special vehicles**—Certain vehicles may be required to stop at all crossings. These include other commercial buses, passenger-carrying vehicles, and vehicles carrying hazardous materials. In addition to the delay incurred by these special vehicles, their stopping may also impose delay on following vehicles.
- **Crossing surface**—In other words, if the surface can be traversed at only 15 mph, the time needed for a vehicle to slow down and cross should be taken into account.
- **Presence of crossing**—This delay occurs regardless of whether a train is approaching or occupying the crossing. Motorists usually slow down in advance of crossings so that they can stop safely if a train is approaching. This is a required safe driving practice in conformance with the Uniform Vehicle Code, which states “...vehicles must stop within 15 to 50 feet from the crossing when a train is in such proximity so as to constitute an immediate hazard.”⁷⁴ Therefore, the existence of a crossing may cause some delays to motorists who slow to look for a train.

Another benefit of crossing elimination is the alleviation of maintenance costs of surfaces and traffic control devices. As discussed in a later chapter on maintenance, these costs can be quite substantial for both highway agencies and railroads.

⁷² *Guidance on Traffic Control Devices at Highway-Rail Grade Crossings*. Washington, DC: Federal Highway Administration (FHWA), Highway/Rail Grade Crossing Technical Working Group, November 2002.
⁷³ *Federal-Aid Policy Guide*. 646.214(c), Washington, DC: FHWA.

⁷⁴ *Uniform Vehicle Code and Model Traffic Ordinance*. National Committee on Uniform Traffic Laws and Ordinances, Evanston, Illinois, 1961, and Supplement, 1984.

Costs of eliminating crossings depend on whether the crossing is merely closed to highway traffic, a grade separation is constructed, or the highway or railroad is relocated. These costs are discussed along with other considerations for each type of elimination alternative.

C. Grade Separation

The decision to grade separate a highway-rail crossing is primarily a matter of economics. Investment in a grade-separation structure is long-term and impacts many users. Such decisions should be based on long-term, fully allocated life-cycle costs, including both highway and railroad user costs, rather than on initial construction costs. Such analysis should consider the following:

- Eliminating train/vehicle collisions (including the resultant property damage and medical costs and liability).
- Savings in highway-rail grade crossing surface and crossing signal installation and maintenance costs.
- Driver delay cost savings.
- Costs associated with providing increased highway storage capacity (to accommodate traffic backed up by a train).
- Fuel and pollution mitigation cost savings (from idling queued vehicles).
- Effects of any “spillover” congestion on the rest of the roadway system.
- Benefits of improved emergency access.
- Potential for closing one or more additional adjacent crossings.
- Possible train derailment costs.

Specific recommendations for grade separation are contained in the FHWA Technical Working Group report in Chapter V.

A recently released report entitled *Grade Separations—When Do We Separate* provides a stepwise procedure for evaluating the grade-separation decision.⁷⁵ The report also contains a rough screening method based on train and roadway vehicular volumes. However, as pointed out in the report, the screening method should be used with caution and should be calibrated for values appropriate for the particular jurisdiction.

75 Nichelson, Jr., G. Rex and George L. Reed. *Grade Separations—When Do We Separate*. 1999 Highway-Rail Grade Crossing Conference. Texas Transportation Institute (TTI), College Station, Texas, October 17–19, 1999 (www.tti.edu or www.tamu.edu).

Recent publications include a methodology reflecting safety and economic factors applied in Israel;⁷⁶ a grade-separation policy for light-rail train crossings with specific highway operational, safety, and rail transit operational criteria adopted by the Los Angeles Metropolitan Transportation Authority;⁷⁷ a methodology applied in central Arkansas that considered use of seven quantitative factors: noise, community cohesion, delay, accessibility, connectivity, geographic distribution, and safety;⁷⁸ and a methodology by Nichelson and Reed presented at the 2001 National Highway-Rail Grade Crossing Safety Conference.⁷⁹

D. Highway and Railroad Relocation

Other alternatives to highway-rail grade crossing problems are relocation of the highway or railroad or railroad consolidation. These alternatives provide a solution to other railroad impacts on communities; however, the costs associated with relocation or consolidation can be quite high.

Railroads provide advantages and disadvantages to communities. They generate employment opportunities for local citizens, provide transportation services to local industries and businesses, and are a source of tax revenue to government agencies. The presence of railroads in communities can impose some disadvantages, such as vehicular delay and safety concerns at highway-rail grade crossings. In addition, the presence of railroads may impose noise and other environmental concerns upon the community. Railroad relocation to the outer limits of the community may be a viable alternative for alleviating these concerns while retaining the advantages of having railroad service. Relocation generally involves the complete rebuilding of railroad facilities. This not only requires track construction but also acquisition of right of

76 Gitelman, Victoria, A. Shalom Hakkert, Etti Doveh, and Ayala Cohen. “Screening Tools for Considering Grade Separation at Rail-Highway Crossings.” *Journal of Transportation Engineering* (January 2006).

77 Ogden, Brent D. “Los Angeles Metropolitan Transportation Authority Grade Crossing Policy: Reducing Uncertainty And Defining Scope And Cost For Light Rail Transit/Roadway Crossings.” Proceedings, American Public Transportation Association Light Rail Conference, Miami, Florida, 2004.

78 Schrader, M.H. and J.R. Hoffpauer. “Methodology For Evaluating Highway-Railway Grade Separations.” *Transportation Research Record*, No. 1754, Traffic Control Devices, Visibility, and Rail-Highway Grade Crossings, 2001.

79 TransTech Group, Inc., G. Rex Nichelson, and George Reed. “A Procedure for the Provision of Highway-Railroad Grade Separations.” 2001 National Highway-Rail Grade Crossing Safety Conference sponsored by TTI, College Station, Texas, April 2001.

way and construction of drainage structures, signals, communications, crossings and separations, station facilities, and utilities.

In some cases, consolidation of railroad lines into common corridors or joint operations over the same trackage may allow for the removal of some trackage through a community. Railroad consolidation may provide benefits similar to those of railroad relocation and, possibly, at lower costs.

Benefits of railroad relocation in addition to those associated with crossing safety and operations include: improved environment resulting from decreased noise and air pollution; improved land use and appearance; and improved railroad efficiency. Railroad relocation and consolidation may also provide for the elimination of obstructions to emergency vehicles and the safer movement of hazardous materials. Collectively, the tangible and intangible benefits may justify the relocation or consolidation of railroad facilities; any one of the benefits alone might not provide sufficient justification for the expense.

Many factors must be considered in planning for railroad relocation. The new location should provide good alignment, minimum grades, and adequate drainage. Sufficient right of way should be available to provide the necessary horizontal clearances, additional rail facilities as service grows, and a buffer for abating noise and vibrations. The number of crossings should be minimized.

The railroad corridor can be further isolated from residential and commercial activity by zoning the property adjacent to the railroad as light and heavy industrial. Businesses and industry desiring rail service can locate in this area.

To accomplish a rail relocation or consolidation project, a partnership is required among the federal government (if federal funds are involved), state and local government agencies, the railroad, and the community. Although the purpose of the project may be only to eliminate physical conflicts between the highway user and the railroad, the partnership developed for this project provides an atmosphere of cooperative working relationships that continues into the future.

Highway relocations are sometimes accomplished to provide improved highway traffic flow around communities and other developed areas. Planning for highway relocations should consider routes that would eliminate at-grade crossings by avoiding the need for access over railroad trackage or by providing grade separations.

E. Closure

Closure of a highway-rail grade crossing to highway traffic should always be considered as an alternative. Numerous crossings were built when railroads first began operating. Safety was not a serious concern because horse-drawn carriages could easily stop and train speeds were low.

Closure of at-grade crossings is normally accomplished by closing the highway. The number of crossings needed to carry highway traffic over a railroad in a community is influenced by many characteristics of the community itself. A study of highway traffic flow should be conducted to determine origin and destination points and needed highway capacity. Thus, optimum routes over railroads can be determined. Highway operation over several crossings may be consolidated to move over a nearby crossing with flashing lights and gates or over a nearby grade separation. Alternative routes should be within a reasonable travel time and distance from a closed crossing. The alternate routes should have sufficient capacity to accommodate the diverted traffic safely and efficiently.

Eliminating redundant and unneeded crossings should be a high priority. Barring highway or railroad system requirements that require crossing elimination, the decision to close or consolidate crossings requires balancing public necessity, convenience, and safety. The crossing closure decision should be based on economics—comparing the cost of retaining the crossing (maintenance, collisions, and cost to improve the crossing to an acceptable level if it remains, etc.) against the cost (if any) of providing alternate access and any adverse travel costs incurred by users having to cross at some other location. Because this can be a local political and emotional issue, the economics of the situation cannot be ignored. This subject is addressed in a 1994 joint FRA/FHWA publication entitled *Highway-Railroad Grade Crossings: A Guide To Crossing Consolidation and Closure* and a March 1995 publication of the American Association of State Highway and Transportation Officials (AASHTO), *Highway-Rail Crossing Elimination and Consolidation*.

Whenever a crossing is closed, it is important to consider whether the diversion of highway traffic may be sufficient to change the type or level of traffic control needed at other crossings. The surrounding street system should be examined to assess the effects of diverted traffic. Often, coupling a closure with the installation of improved or upgraded traffic control devices at one or more adjacent crossings can be an

effective means of mitigating local political resistance to the closure.⁸⁰

There are several stumbling blocks to successful closure, such as negative community attitudes, funding problems, and the lack of forceful state laws authorizing closure or the reluctant utilization of state laws that permit closure.

Legislation that authorizes a state agency to close crossings greatly facilitates the implementation of closures. These state agencies should utilize their authority to close crossings whenever possible. Often, a state agency can accomplish closure where local efforts fail due to citizen biases and fear of losing access across the railroad. Local opposition sometimes may be overcome through emphasizing the benefits resulting from closure, such as improved traffic flow and safety as traffic is redirected to grade separations or crossings with active traffic control devices. Railroads often support closure not only because of safety concerns but also because maintenance costs associated with the crossing are eliminated. A list of who is responsible for closing public crossings in each state is shown in Table 34. Appendix H presents a more detailed state-by-state summary of the procedures for grade crossing elimination.

Achieving consensus among state transportation divisions, boards, review committees, railroads, municipalities, and the public is integral to the closure process. Closure criteria vary by locality but typically include train and roadway traffic volume, speed of trains, number of tracks, material being carried, crossing location, visibility, distance to traffic signals, and number of crashes. More than four crossings per mile with fewer than 2,000 vehicles per day and more than two trains per day are prime candidates for closure.⁸¹

To assist in the identification of crossings that may be closed, the systems approach might be utilized, as discussed in Chapter III. With this method, several crossings in a community or rail corridor are improved by the installation of traffic control devices; other crossings are closed. This is accomplished following a study of traffic flows in the area to assure continuing access across the railroad. Traffic flows are sometimes improved by the installation of more sophisticated traffic control systems at the remaining crossings and, perhaps, the construction of a grade separation at one of the remaining crossings.

80 *Guidance on Traffic Control Devices at Highway-Rail Grade Crossings*. Washington, DC: FHWA, Highway/Rail Grade Crossing Technical Working Group, November 2002.

81 Carroll, Anya A. and Judith D. Warren. "Closure of U.S. Highway Grade Crossings: A Status Report." Washington, DC: Transportation Research Board 82nd Annual Meeting Compendium of Papers CD-ROM, January 12-16, 2003.

Table 34. Responsibility for Closing Public Crossings

State agency	Regulatory commission	Local jurisdiction	No code or authority specifically mentioned
Alabama*	Arizona	Alabama*	Alaska
Delaware	Arkansas	Illinois	Hawaii
District of Columbia	California	Iowa*	New Jersey
Florida	Colorado	Louisiana*	New Mexico
Georgia	Connecticut	Nebraska	
Idaho	Kansas*	Ohio	
Indiana	Minnesota	Texas*	
Iowa*	Mississippi		
Kansas*	Montana		
Kentucky	Nevada		
Louisiana*	New Hampshire		
Maine	New York		
Maryland	North Dakota		
Massachusetts	Oklahoma		
Michigan	Pennsylvania		
Missouri	Rhode Island		
Nebraska	South Carolina		
North Carolina	Tennessee*		
Oregon	Texas*		
South Dakota	Vermont		
Tennessee*	Virginia		
Utah	Washington		
Wisconsin	West Virginia		
	Wyoming		

* Shares responsibility with other state organization.

Source: From Transportation Research Board 82nd Annual Meeting Compendium of Papers CD-ROM, January 12-16, 2003, Transportation Research Board of the National Academies, Washington, DC. Reprinted with permission.

Another important matter to consider in connection with crossing closure is access over the railroad by emergency vehicles, ambulances, fire trucks, and police. Crossings frequently utilized by emergency vehicles should not be closed. On the contrary, these crossings should be candidates for grade separations or the installation of active traffic control devices. Specific criteria to identify crossings that should be closed are difficult to establish because of the numerous and various factors that should be considered. The *Traffic Control Devices Handbook* suggests criteria that may be used for crossing closure. It is important that these criteria not be used without professional, objective, engineering, and economic assessment of the positive and negative impacts of crossing closures.

Criteria for crossings on branch lines include:

- Less than 2,000 average daily traffic (ADT).
- More than two trains per day.
- Alternate crossing within 0.25 mile that has less than 5,000 ADT if two lanes or less than 15,000 ADT if four lanes.

Criteria for crossings on spur tracks include:

- Less than 2,000 ADT.
- More than 15 trains per day.
- Alternate crossing within 0.25 mile that has less than 5,000 ADT if two lanes or less than 15,000 ADT if four lanes.

Criteria for crossing on mainline:

- Any mainline section with more than five crossings within a 1-mile segment.

The guidance document developed by the U.S. DOT Technical Working Group provides specific criteria for screening of crossings for closure applicable to mainline trackage (see Chapter V). When a crossing is permanently closed to highway traffic, the existing crossing should be obliterated by removing the crossing surface pavement markings and all traffic control devices both at the crossing and approaching the crossing.

Generally, the railroad is responsible for removing the crossing surface and traffic control devices located at the crossing, such as the crossbuck sign, flashing light signals, and gates.

The highway authority is responsible for removing traffic control devices in advance of and approaching the crossing, such as the advance warning signs and pavement markings. Nearby highway traffic signals that are interconnected with crossing signals located at the closed crossing should have their phasing and timing readjusted.

The highway authority is also responsible to alert motorists that the crossing roadway is now closed. A Type III barricade, shown in Figure 10, may be erected. If used, this barricade shall meet the design criteria of Section 6F.63 of the *Manual on Uniform Traffic Control Devices* (MUTCD), except the colors of the stripes shall be reflectorized white and reflectorized red. Characteristics of a Type III barricade are provided in Figure 10.

Figure 10. Type III Barricade*

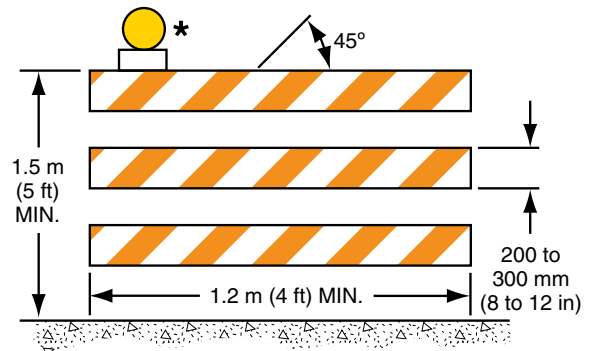

* Rail stripe widths shall be 150 millimeters (mm) (6 inches (in.)), except that 100-mm (4-in.) wide stripes may be used if rail lengths are less than 900 mm (36 in.). The sides of barricades facing traffic shall have retroreflective rail faces.

Note: If barricades are used to channelize pedestrians, there shall be continuous detectable bottom and top rails with no gaps between individual barricades to be detectable to users of long canes. The bottom of the bottom rail shall be no higher than 150 mm (6 in.) above the ground surface. The top of the top rail shall be no lower than 900 mm (36 in.) above the ground surface.

Source: Manual on Uniform Traffic Control Devices, 2003 Edition. Washington, DC: Federal Highway Administration, 2003.

Warning and regulatory signing in accordance with MUTCD should be installed to alert motorists that the crossing roadway is now closed. These signs include the “Road Closed” sign (R11-2), “Local Traffic Only” sign (R11-3, R11-4), and appropriate advance warning signs as applicable to the specific crossing.

Consideration should also be given to advising motorists of alternate routes across the railroad. If trucks use the crossing being closed, they should be given advance information about the closure at points where they can conveniently alter their route.

1. Closure Programs

One grade crossing closure initiative was established by the Burlington Northern and Santa Fe Railway Company (BNSF) in 2000. This initiative is part of BNSF’s grade crossing safety program, which has the goal of reducing grade crossing collisions, injuries, and fatalities. The grade crossing safety program also includes community education, enhanced crossing technology, crossing resurfacing, vegetation control, installation of warning devices, and track and signal inspection and maintenance. In March 2006, BNSF closed its 3,000th highway-rail grade crossing since the beginning of its grade crossing closure initiative. By eliminating unnecessary and redundant crossings,

BNSF has made an important contribution to community safety while also improving the efficiency and safety of its rail operation. There are three key elements of BNSF's grade crossing closure initiative:

- A closure team was assembled, bringing together field safety and the public projects group in engineering.
- Closure candidates were identified by division engineering and transportation personnel.
- A closure database was developed to track progress.

Another example of a closure program is the effort begun by the North Carolina Department of Transportation (NCDOT) in 1993. North Carolina recorded its 100th crossing closure in 2004.⁸² NCDOT criteria consider:

- Crossings within one-quarter-mile of one another that are part of the same highway or street network.
- Crossings where vehicular traffic can be safely and efficiently redirected to an adjacent crossing.
- Crossings where a high number of crashes have occurred.
- Crossings with reduced sight distance because of the angle of the intersection, curve of the track, trees, undergrowth, or man-made obstructions.
- Adjacent crossings where one is replaced with a bridge or upgraded with new signaling devices.
- Several adjacent crossings when a new one is being built.
- Complex crossings where it is difficult to provide adequate warning devices or that have severe operating problems, such as multiple tracks, extensive railroad-switching operations, or long periods of blocked crossings.
- Private crossings for which no responsible owner can be identified.
- Private crossings where the owner is unable or unwilling to fund improvements and where alternate access to the other side of the tracks is reasonably available.

⁸² *Consolidating Railroad Crossings: On Track for Safety in North Carolina*. Rail Division, Engineering and Safety Branch, North Carolina Department of Transportation, 2000 (www.dot.state.nc.us/).

NCDOT considers the following factors in deciding whether to close or improve a crossing:

- Collision history.
- Vehicle and train traffic (present and projected).
- Type of roadway (thoroughfare, collector, local access, truck route, school bus route, or designated emergency route).
- Economic impact of closing the crossing.
- Alternative roadway access.
- Type of property being served (residential, commercial, or industrial).
- Potential for bridging by overpass or underpass.
- Need for enhanced warning devices (four-quadrant gates, longer arm gates, or median barriers).
- Feasibility for roadway improvements.
- Crossing condition (geometry, sight distance, and crossing surface).
- Available federal, state, and/or local funding.

Closure implementation strategies used by NCDOT include:

- Constructing a connector road or improving roadways along alternate routes to direct traffic to an adjacent crossing.
- Dead-ending affected streets and rerouting traffic, creating cul-de-sacs.
- Constructing bridges.
- Relocating or consolidating railroad operations.

2. Crossing Consolidation and Safety Programs

A highly effective approach to improving safety involves the development of a program of treatments, including safety improvements, grade separations, and crossing closures, to eliminate significant numbers of crossings within a specified section of rail line while improving those that remain at grade. Both FRA and AASHTO have provided guidelines for crossing consolidation. State departments of transportation, road authorities, and local governments may choose to develop their own criteria for closures based on local conditions. Whatever the case, a specific criterion or approach should be used to avoid arbitrarily selecting crossings for closure. Examples include the previously noted NCDOT consolidation effort as well as the Alameda Corridor–East project in southern California, which was developed as a result of a grade crossing corridor study.⁸³

⁸³ *San Gabriel Valley Grade Crossings Study*, San Gabriel Valley Council of Governments, Korve Engineering, Inc., January 1997.

To improve crossing safety and provide a comprehensive approach to crossing consolidation, the traffic separation study approach is a worthwhile option. As part of a comprehensive evaluation of traffic patterns and road usage for an entire municipality or region, traffic separation studies determine the need for improvements and/or elimination of public highway-rail grade crossings based on specific criteria. Traffic separation studies progress in three phases: preliminary planning, study, and implementation.

Crossing information is collected at all public crossings in the municipality. Evaluation criteria include collision history; current and projected vehicular and train traffic; crossing condition; school bus and emergency routes; types of traffic control devices; feasibility for improvements; and economic impact of crossing closures. After discussions with the local road authority, railroad, state department of transportation, municipal staff, and local officials, these recommendations may be modified. Reaching a consensus is essential prior to scheduling presentations to governing bodies and citizens.

Recommendations resulting from a traffic separation study may include installation of flashing lights and gates; enhanced devices such as four-quadrant gates and longer gate arms; installation of concrete or rubber crossings; median barrier installation; pavement markings; roadway approach modifications; crossing or roadway realignments; crossing closures and/or relocation of existing crossings to safer locations; connector roads; and feasibility studies to evaluate potential grade-separation locations.

A key element of a traffic separation study is the inclusion of a public involvement element, including crossing safety workshops and public hearings. The goal of these forums is to exchange information and convey the community benefits of enhanced crossing safety, including the potential consequences to neighborhoods of train derailments containing hazardous materials resulting from crossing collisions. Equating rail crossings to highway interchanges, something the average citizen can relate to, greatly assists in reinforcing the need for eliminating low-volume and/or redundant crossings.⁸⁴

⁸⁴ *Guidance on Traffic Control Devices at Highway-Rail Grade Crossings*. Washington, DC: FHWA, Highway/Rail Grade Crossing Technical Working Group, November 2002.

F. Abandoned Crossings

Highway-rail grade crossings on abandoned railroad lines present a different kind of safety and operational problem. Motorists who consistently drive over crossings that are not maintained but have traffic control devices and at which they never see a train may develop a careless attitude and not take appropriate caution. Motorist may maintain this attitude and behavior at crossings that have not been abandoned, perhaps resulting in a collision with a train. Thus, credibility of crossing traffic control devices may be reduced, not only for the abandoned crossing but for other crossings as well.

Operational problems exist for abandoned crossings where existing traffic control devices and/or tracks for the crossing have not been removed. A careful motorist will slow down in advance of every crossing, especially those with passive traffic control devices. If the track has been abandoned, unnecessary delays result, particularly for special vehicles required by federal and state laws to stop in advance of every crossing. These special vehicles include school buses, vehicles carrying passengers for hire, and vehicles transporting hazardous materials. In addition, these vehicles may be involved in vehicle-vehicle collisions because other motorists might not expect drivers of these vehicles to stop.

The desirable action for abandoned crossings is to remove all traffic control devices related to the crossing and remove or pave over the tracks. The difficulty is in identifying abandoned railroad lines. For example, a railroad may discontinue service over a line or a track with the possibility that another railroad, particularly a short-line railroad, may later purchase or lease the line to resume that service. These railroad lines are called inactive lines and, obviously, removing or paving over the track will add substantial cost in reactivating the service.

Another type of inactive rail line is one with seasonal service. For example, rail lines that serve grain elevators may only have trains during harvest season. The lack of use during the rest of the year may cause the same safety and operational problems described earlier.

The first step in addressing the problem of crossings on abandoned rail lines is to obtain information from the Surface Transportation Board (STB) or a state regulatory commission. Railroads are required to apply to STB for permission to abandon a rail line. In addition, some state laws require railroads to also apply for permission or to notify a state agency of intentions to abandon the line. The state highway engineer responsible for crossing safety and operations

should be notified of these intentions. The state highway agency might work out an agreement with the state regulatory commission that any information on railroad abandonments is automatically sent to the state highway agency. Additionally, the state highway agency should periodically call the state regulatory commission or STB to obtain the records on rail abandonments in the state. Railroad personnel responsible for crossing safety and operations should also seek the same information from their traffic and operating departments.

Once a rail line has been identified as abandoned or abandonment is planned, the crossings on that line should be identified. This can be determined from the state inventory of crossings or obtained from FRA, custodian of the U.S. DOT National Highway-Rail Crossing Inventory. A field inspection of these crossings should be made to determine if all crossings on that line, both public and private, are listed in the inventory and to verify the type of traffic control devices located at each crossing.

This field inspection provides an excellent opportunity to assess the safety and operations of each crossing on that line, as discussed in Chapter III. If the rail line is not abandoned, the necessary information has been gathered to improve each crossing by one of the alternatives described in following sections.

If rail service has been discontinued, pending resolution of the abandonment application and formal abandonment, immediate measures should be taken to inform the public. For example, “Exempt” signs, if authorized by state law or regulation, can be placed at the crossing to notify drivers of special vehicles that a stop at the crossing is not necessary. Gate arms should be removed, and flashing light signal heads should be hooded, turned, or removed. However, if these actions are taken, the traffic control devices must be restored to their original condition prior to operating any trains over the crossing. For any subsequent use of the crossing by rail traffic pending final abandonment, the railroad shall provide flagging, law enforcement, or other case-by-case manual control of the crossing. The railroad might flag the train over the crossing until such action can be taken.

If it appears that rail service has been permanently discontinued, and resolution of official abandonment appears certain, the track should be paved over and all traffic control devices removed. This action should be taken immediately following official abandonment if no possibility exists for resumption of rail service. This can be determined by examining the potential for industry or business to require rail service. For

example, if the rail line was abandoned because the industry that required the service has moved and other plans for the land area have been made, it could be determined whether need for the rail service will continue. An agreement may be necessary between the public authority and the railroad to accomplish the physical removal of the tracks.

G. New Crossings

Similar to crossing closure/consolidation, opening a new public highway-rail crossing should likewise consider public necessity, convenience, safety, and economics. Generally, new grade crossings, particularly on mainline tracks, should not be permitted unless no other viable alternatives exist and, even in those instances, consideration should be given to closing one or more existing crossings. If a new grade crossing is to provide access to any land development, the selection of traffic control devices to be installed at the proposed crossing should be based on the projected needs of the fully completed development.

Communities, developers, and highway transportation planners need to be mindful that once a highway-rail grade crossing is established, drivers can develop a low tolerance for the crossing being blocked by a train for an extended period of time. If a new access is proposed to cross a railroad where railroad operation requires temporarily holding trains, only grade separation should be considered.⁸⁵

H. Passive Traffic Control Devices

Passive traffic control devices provide static messages of warning, guidance, and, in some instances, mandatory action for the driver. Their purpose is to identify and direct attention to the location of a crossing to permit drivers and pedestrians to take appropriate action. Passive traffic control devices consist of regulatory signs, warning signs, guide signs, and supplemental pavement markings. They are basic devices and are incorporated into the design of active traffic control devices.

Signs and pavement markings are to be in conformance with MUTCD, which is revised periodically as the need arises. If there are differences between this handbook and the current edition of MUTCD concerning both active and passive traffic control devices, MUTCD should be

⁸⁵ Ibid.

followed. The diagrams shown in this handbook are taken from the current version of MUTCD (2003 Edition, Revision 1). Practitioners should confirm all signs, dimensions, and criteria with the latest edition of MUTCD.

Federal law requires that, as a minimum, each state shall provide signs at all crossings. The railroad crossbuck sign and other supplemental signs attached to the crossbuck must be usually installed and maintained by the railroad company. The agency responsible for

maintenance of the roadway is normally responsible for advance warning signs and pavement markings.

1. Signs

The typical signs used at highway-rail grade crossings are shown in Figure 11 and listed in Table 35. Individual characteristics and location requirements follow.

Figure 11. Typical Crossing Signs

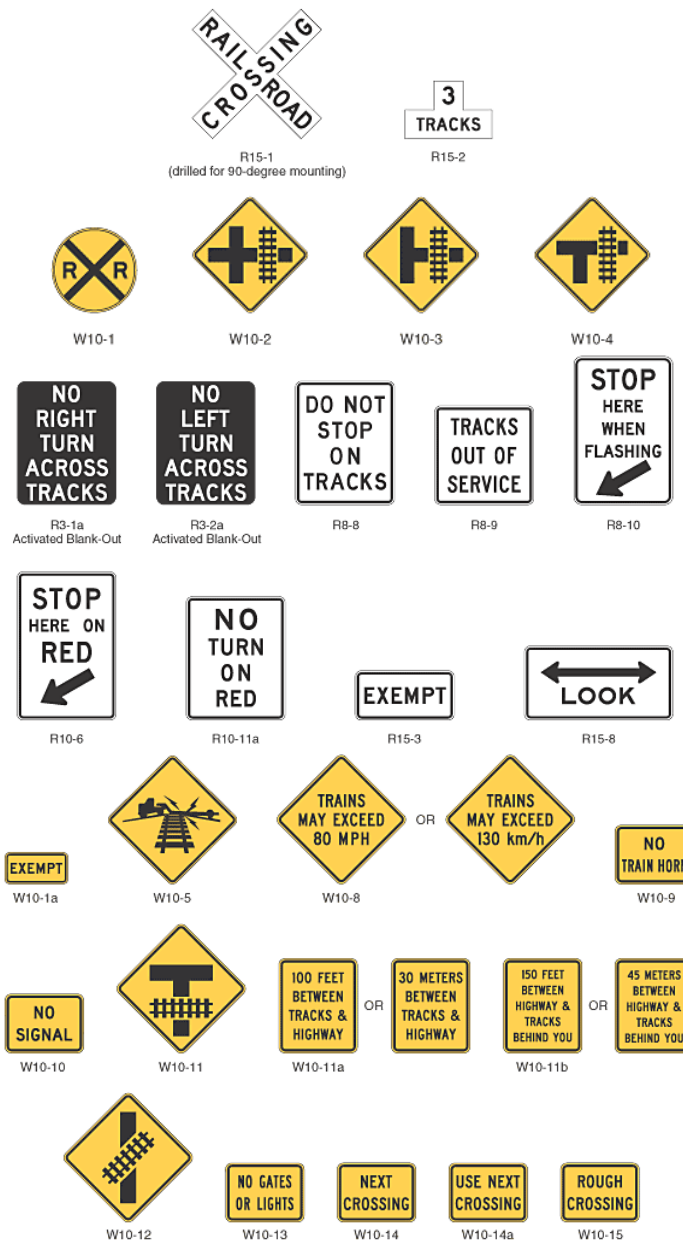

Source: Manual on Uniform Traffic Control Devices, 2003 Edition. Washington, DC: Federal Highway Administration, 2003.

Table 35. Current MUTCD Devices

MUTCD no.	Section	Traffic control device	Application or indication of need
R3-1a	8B.06, 10C.09	No Right Turn Across Tracks	Used to prohibit turning movements toward the highway-rail grade crossing during preemption.
R3-2a	8B.06, 10C.09	No Left Turn Across Tracks	Used to prohibit turning movements toward the highway-rail grade crossing during preemption.
R8-8	8B.07, 10C.05	Do Not Stop on Tracks	Where queuing occurs or where storage space is limited between a nearby highway intersection and the tracks; may be supplemented with a flashing light activated by queuing traffic in the exit lane(s) from the crossing. (See discussion on queue cutter signals.)
R8-9	8B.09, 10C.06	Tracks Out of Service	Applicable when there is some physical disconnection along the railroad tracks to prevent trains from using those tracks.
R8-10	8B.10, 10C.08	Stop Here When Flashing	May be used at a highway-rail grade crossing to inform drivers of the location of the stop line or the point at which to stop when the flashing light signals (Section 8D.02) are activated.
R10-6	8B.11, 10C.07	Stop Here on Red	May be used at locations where vehicles frequently violate the stop line or where it is not obvious to road users where to stop.
R10-11a	8D.07, 10C.09	No Turn on Red	If there is a nearby signalized intersection with insufficient clear storage distance for a design vehicle or the highway-rail grade crossing does not have gates.
R15-1	8B.03, 10C.02	Highway-Rail Grade Crossing (crossbuck)	Required device.
R15-2	8B.03, 10C.02	Number of Tracks	Standard required device, with two or more tracks and no gate; optional with gate.
R15-3	8B.05, 10C.10	Exempt	School buses and commercial vehicles that are usually required to stop at crossings are not required to do so where authorized by ordinance.
R15-4a	10C.13	Light Rail Only Right Lane	For multilane operations where roadway users might need additional guidance on lane use and/or restrictions.
R15-4b	10C.13	Light Rail Only Left Lane	For multilane operations where roadway users might need additional guidance on lane use and/or restrictions.
R15-4c	10C.13	Light Rail Only Center Lane	For multilane operations where roadway users might need additional guidance on lane use and/or restrictions.
R15-5	10C.14	Light Rail Do Not Pass	Where vehicles are not allowed to pass LRT vehicles loading or unloading passengers where no raised platform physically separates the lanes.
R15-5a	10C.14	Do Not Pass Stopped Train	Where vehicles are not allowed to pass LRT vehicles loading or unloading passengers where no raised platform physically separates the lanes.
R15-6	10C.12	Do Not Drive On Tracks Light Rail Symbol	Used where there are adjacent vehicle lanes separated from the LRT lane by a curb or pavement markings.
R15-6a	10C.12	Do Not Drive On Tracks	Used where there are adjacent vehicle lanes separated from the LRT lane by a curb or pavement markings.
R15-7	10C.11	Light Rail Divided Highway Symbol	Use with appropriate geometric conditions.
R15-7a	10C.11	Light Rail Divided Highway Symbol (T-intersection)	Use with appropriate geometric conditions.
R15-8	8B.16, 10C.03	Look	<ul style="list-style-type: none"> • Multiple tracks • Collision experience • Pedestrian presence
W10-1	8B.04, 10C.15	Highway-Rail Grade Crossing Advance Warning	Required device, with MUTCD exceptions (Section 8B.04); school buses and commercial vehicles that are usually required to stop at crossings are not required to do so where authorized by ordinance.
W10-1a	8B.05, 10C.10	Exempt	

(continued)

MUTCD no.	Section	Traffic control device	Application or indication of need
W10-2,3,4	8B.04, 10C.15	Highway-Rail Grade Crossing Advance Warning	Based upon specific situations with a nearby parallel highway.
W10-5	8B.17, 10C.16	Low Ground Clearance Highway-Rail Grade Crossing	As indicated by MUTCD guidelines, incident history, or local knowledge.
W10-7	10C.17	Light Rail Activated Blank-Out Symbol	Supplements the traffic control signal to warn road users turning across the tracks of an approaching parallel LRT vehicle.
W10-8	8B.13	Trains May Exceed 130 km/h (80 mph)	Where train speed is 80 mph (130 km/hr.) or faster.
W10-9	8B.14	No Train Horn	Shall be used only for crossings in FRA-authorized quiet zones.
W10-10	8B.15	No Signal	May be used at passive controlled crossings.
W10-11	8B.18, 10C.18	Storage Space Symbol	Where the parallel highway is close to the crossing, particularly with limited storage space between the highway intersection and tracks.
W10-11a	8B.18, 10C.18	Storage Space XX Meters (Feet) Between Tracks & Highway	Where the parallel highway is close to the crossing, particularly with limited storage space between the highway intersection and tracks.
W10-11b	8B.18, 10C.18	Storage Space XX Meters (Feet) Between Highway & Tracks Behind You	Used where there is a highway intersection in close proximity to the highway-rail grade crossing and an engineering study determines that adequate space is not available to store a design vehicle(s) between the highway intersection and the train dynamic envelope.
W10-12	8B.19, 10C.19	Skewed Crossing	May be used at a skewed highway-rail grade crossing to warn drivers that the railroad tracks are not perpendicular to the highway.
W10-13	8B.15	No Gates or Lights	May be installed at highway-rail grade crossings that are not equipped with automated signals.
W10-14	8B.17	Next Crossing	Placed below the W10-5 sign at the nearest intersecting highway where a vehicle can detour or at a point on the highway wide enough to permit a U-turn.
W10-14a	8B.17	Use Next Crossing	Placed below the W10-5 sign at the nearest intersecting highway where a vehicle can detour or at a point on the highway wide enough to permit a U-turn.
W10-15	8B.17	Rough Crossing	If the highway-rail grade crossing is rough.
I-12	10C.20	Light Rail Station Symbol	Used to direct road users to a light rail station or boarding location.
I-13	8B.12, 10C.21	Emergency Notification	Post at all crossings to provide for emergency notification.
I-13a	8B.12, 10C.21	Emergency Notification	Post at all crossings to provide for emergency notification.

Source: Manual on Uniform Traffic Control Devices, 2003 Edition. Washington, DC: Federal Highway Administration, 2003.

In general, MUTCD specifies that signs should be located on the right-hand side of the highway, where the driver is looking for them. Signs should be located to optimize visibility. Signs should not be located in a highway dip or beyond the crest of a hill. Care should be taken so that the sign is not obscured by parked cars or foliage or covered by roadside splatter or snow accumulation.

In rural areas, signs along the side of the road should be at least 5 feet high, measured from the bottom of the

sign to the elevation of the near edge of the pavement. In business, commercial, and residential areas, where parking and/or pedestrian movements are likely to occur or where there are other sight obstructions, the clearance to the bottom of the sign should be at least 7 feet. The height to the bottom of a secondary sign mounted below another sign may be 1 foot lower than the height specified above.

Signs should have the maximum practical lateral clearance from the edge of the traveled way for the

safety of motorists who may leave the highway and strike the sign supports (see MUTCD, 2003 Edition, Section 2A.19). Advantage should be taken of existing guardrails, overcrossing structures, and other conditions to minimize the exposure of sign supports to traffic.

Normally, signs should not be closer than 6 feet from the edge of the shoulder or, if none, 12 feet from the edge of the traveled way. In urban areas, a lesser clearance may be used where necessary. Although 2 feet is recommended as a working urban minimum, a clearance of 1 foot from the curb face is permissible if sidewalk width is limited or where existing poles are close to the curb.

Signs should be mounted approximately at right angles to the direction of and facing the traffic they are intended to serve. Post-mounted signs located close to the highway should be turned slightly away from the highway to avoid the reflection of headlights off the sign directly back into drivers' eyes.

Sign posts and their foundations and sign mountings should be constructed to hold signs in a proper and permanent position, to resist swaying in the wind or displacement by vandalism. If ground-mounted sign supports cannot be sufficiently offset from the pavement edge, sign supports should be of a suitable breakaway or yielding design. Concrete bases for sign supports should be flush with the ground level.

Sign materials are usually aluminum, wood, or galvanized or nongalvanized steel. Signs are retroreflectorized or illuminated to provide visibility at night. The requirements of sign illumination are not considered to be satisfied by street or highway lighting or by strobe lighting. Information on reflective materials is contained in the *Traffic Control Devices Handbook*. A 2003 study presents updated minimum recommended retroreflectivity levels in recognition of available sheeting materials, the needs of older drivers, and the evolution of vehicles and headlamps.⁸⁶ FHWA has been developing standards on the retroreflectivity of signs, which include minimum values to be provided and maintained. FHWA recently published a Supplemental Notice of Proposed Amendments to MUTCD. The provisions were out for comment at the time this handbook was prepared.⁸⁷

86 Carlson, Paul J. and H. Gene Hawkins, Jr. *Updated Minimum Retroreflectivity Levels for Traffic Signs*. FHWA-RD-03-081, July 2003.

87 23CFR Part 655, FHWA Docket No. FHWA-2003-15149. Federal Register, May 8, 2006.

“Railroad Crossing” (crossbuck) sign (R15-1) and “Number of Tracks” sign (R15-2).

The “Railroad Crossing” sign, commonly identified as the crossbuck sign, consists of a white reflectorized background with the words RAILROAD CROSSING in black lettering, as shown in Figures 11 and 12. A minimum of one crossbuck shall be used on each highway approach to every crossing, alone or in combination with other traffic control devices.

Note: Crossbuck signs are not usually used at light-rail grade crossings where the tracks run in the street and traffic is controlled by traffic signals. Refer to Chapter IX, Part C for a discussion of clarifying language approved by the National Committee on Uniform Traffic Control Devices (NCUTCD) in June 2005. If there are two or more tracks at the crossing, the number of tracks is to be indicated on an auxiliary sign mounted below the crossbuck, as shown in Figure 12. The use of this auxiliary sign is optional at crossings with automatic gates.

Figure 12. Crossing Sign (Crossbuck)

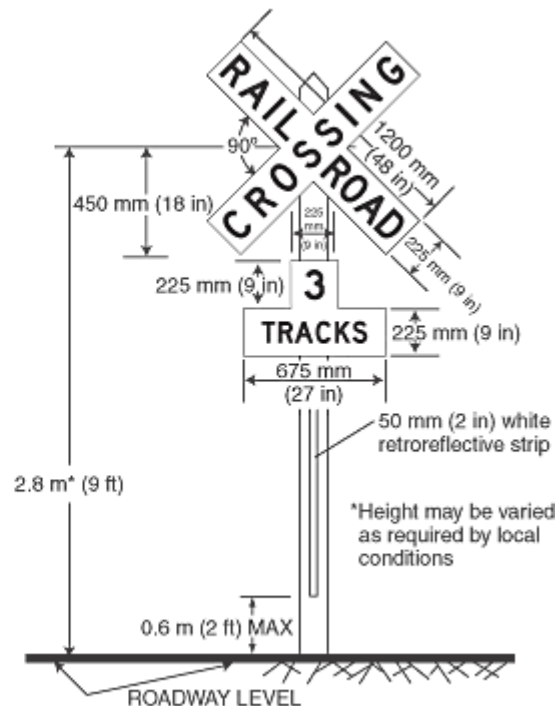

Source: Manual on Uniform Traffic Control Devices, 2003 Edition. Washington, DC: Federal Highway Administration, 2003.

Where physically feasible and visible to approaching traffic, the crossbuck sign should be installed on the right-hand side of the highway on each approach to the crossing. Where an engineering study finds restricted

sight distance or unfavorable road geometry, crossbuck signs shall be placed back to back or otherwise located so that two faces are displayed to that approach. Some states and railroads use back-to-back crossbucks at every crossing; other states and railroads place reflectorized white stripes on the back of every crossbuck.

Crossbuck signs should be located with respect to the highway pavement or shoulder as discussed above for all signs and should be located with respect to the nearest track in accordance with signal locations as discussed in the next section. Where unusual conditions exist, the placement of crossbucks should provide the best possible combination of view and safety clearances as determined by engineering judgment.

Advance warning signs (W10-1, W10-2, W10-3, W10-4). The round, black, and yellow advance warning sign (W10-1) is located in advance of the crossing and serves to alert the motorist that a crossing is ahead. The advance warning sign has a minimum diameter of 36 inches for conventional roads. The sign is required in advance of all crossings except:

- On an approach to a highway-rail grade crossing from a T-intersection with a parallel highway, if the distance from the edge of the track to the edge of the parallel roadway is less than 30 meters (100 feet) and W10-3 signs are used on both approaches of the parallel highway; or
- On low-volume, low-speed highways crossing minor spurs or other tracks that are infrequently used and are flagged by train crews; or
- In business districts where active highway-rail grade crossing traffic control devices are in use; or
- Where physical conditions do not permit even a partially effective display of the sign.

When the crossing is on a divided highway, it is desirable to place an additional advance warning sign on the left side of each approach. It may also be desirable to place an additional sign on the left side of a highway approach when the highway alignment limits the visibility of signs mounted on the right side.

The distance from the advance warning sign to the track is dependent upon the highway speed but in no case should be less than 100 feet in advance of the nearest rail. This distance should allow the driver sufficient time to comprehend and react to the sign's

message and to perform any necessary maneuver. The recommended distances are shown in Tables 36 and 37. Condition A is used for advanced warning sign placement.

Where a road runs parallel to a railroad and the perpendicular distance between the two is less than 100 feet, there is not enough distance to display the advance warning sign (W10-1). For traffic turning from the parallel road, one of three other warning signs (W10-2, W10-3, and W10-4) can be used when their need has been determined from an engineering study. Figure 13 shows typical sign placements for crossings located near highway intersections; Figure 14 indicates a recommended treatment for crossings that lack adequate clear storage distance; and Figure 15 shows possible signage placement for locations with limited sight distance.

“No Signal” and “Signal Ahead” signs (W10-10 and W10-16). A recent study of passive devices at highway-rail grade crossings recommended that a supplemental sign should be placed at the location of the advance warning sign to inform highway users as to whether passive or active devices are present at a downstream grade crossing.⁸⁸ Subsequently, at the January 2006 meeting of NCUTCD, the council approved proposed changes to MUTCD that would allow use of “No Signal” and “Signal Ahead” signs (W10-10 and W10-16) for locations where the grade crossing advance warning sign is placed.

Advisory speed plate (W13-1). The advisory speed plate should be used when sight or geometric conditions require a speed lower than the posted speed limit. It should not be erected until the recommended speed has been determined by an engineering study of the specific crossing. If the plate is used, the recommended speed should be periodically reviewed and revised as necessary. Should it be determined that the advisory speed plate is not effective in reducing vehicular speeds, it may be appropriate to use a regulatory speed limit sign (R2-1). The advisory speed plate must be mounted on the same assembly and is normally below the advance warning sign (W-10 series).

STOP and YIELD signs (R1-1 & R1-2). The 2003 edition of MUTCD requires the crossbuck (R15-1) sign for all highway approaches to railroad grade crossings. It also allows the optional use of YIELD or STOP signs at passive crossings.

88 Lerner, Neil D. et al. *Traffic-Control Devices for Passive Railroad-Highway Grade Crossings*. Washington, DC: National Cooperative Highway Research Program Report 470, Transportation Research Board, 2002.

Table 36. Placement Distances for Advance Warning Signs (English Units)

Posted or 85th-Percentile Speed	Advance Placement Distance ¹								
	Condition A: Speed Reduction and Lane Changing in Heavy Traffic ²	Condition B: Deceleration to the listed advisory speed (mph) for the condition ⁴							
		0 ³	10	20	30	40	50	60	70
20 mph	225 ft.	N/A ⁵	N/A ⁵	—	—	—	—	—	—
25 mph	325 ft.	N/A ⁵	N/A ⁵	N/A ⁵	—	—	—	—	—
30 mph	450 ft.	N/A ⁵	N/A ⁵	N/A ⁵	—	—	—	—	—
35 mph	550 ft.	N/A ⁵	N/A ⁵	N/A ⁵	N/A ⁵	—	—	—	—
40 mph	650 ft.	125 ft.	N/A ⁵	N/A ⁵	N/A ⁵	—	—	—	—
45 mph	750 ft.	175 ft.	125 ft.	N/A ⁵	N/A ⁵	N/A ⁵	—	—	—
50 mph	850 ft.	250 ft.	200 ft.	150 ft.	100 ft.	N/A ⁵	—	—	—
55 mph	950 ft.	325 ft.	275 ft.	225 ft.	175 ft.	100 ft.	N/A ⁵	—	—
60 mph	1100 ft.	400 ft.	350 ft.	300 ft.	250 ft.	175 ft.	N/A ⁵	—	—
65 mph	1200 ft.	475 ft.	425 ft.	400 ft.	350 ft.	275 ft.	175 ft.	N/A ⁵	—
70 mph	1250 ft.	550 ft.	525 ft.	500 ft.	425 ft.	350 ft.	250 ft.	150 ft.	—
75 mph	1350 ft.	650 ft.	625 ft.	600 ft.	525 ft.	450 ft.	350 ft.	250 ft.	100 ft.

Notes:

¹ The distances are adjusted for a sign legibility distance of 175 ft. for Condition A. The distances for Condition B have been adjusted for a sign legibility distance of 250 ft., which is appropriate for an alignment warning symbol sign.

² Typical conditions are locations where the road user must use extra time to adjust speed and change lanes in heavy traffic because of a complex driving situation. Typical signs are Merge and Right Lane Ends. The distances are determined by providing the driver a PIEV time of 14.0 to 14.5 seconds for vehicle maneuvers (2001 AASHTO Policy, Exhibit 3-3, Decision Sight Distance, Avoidance Maneuver E) minus the legibility distance of 175 ft. for the appropriate sign.

³ Typical condition is the warning of a potential stop situation. Typical signs are Stop Ahead, Yield Ahead, Signal Ahead, and Intersection Warning signs. The distances are based on the 2001 AASHTO Policy, Stopping Sight Distance, Exhibit 3-1, providing a PIEV time of 2.5 seconds, a deceleration rate of 11.2 ft./second², minus the sign legibility distance of 175 ft.

⁴ Typical conditions are locations where the road user must decrease speed to maneuver through the warned condition. Typical signs are Turn, Curve, Reverse Turn, or Reverse Curve. The distance is determined by providing a 2.5 second PIEV time, a vehicle deceleration rate of 10 ft./second², minus the sign legibility distance of 250 ft.

⁵ No suggested distances are provided for these speeds, as the placement location is dependent on site conditions and other signing to provide an adequate advance warning for the driver.

Source: Manual on Uniform Traffic Control Devices, 2003 Edition. Washington, DC: Federal Highway Administration, 2003.

Table 37. Placement Distances for Advance Warning Signs (Metric Units)

Posted or 85th-Percentile Speed (km/hr.)	Advance Placement Distance ¹												
	Condition A: Speed Reduction and Lane Changing in Heavy Traffic ²	Condition B: Deceleration to the listed advisory speed (km/hr.) for the condition ⁴											
		0 ³	10	20	30	40	50	60	70	80	90	100	110
30	60 m	N/A ⁵	N/A ⁵	—	—	—	—	—	—	—	—	—	—
40	100 m	N/A ⁵	N/A ⁵	N/A ⁵	—	—	—	—	—	—	—	—	—
50	150 m	N/A ⁵	N/A ⁵	N/A ⁵	—	N/A ⁵	—	—	—	—	—	—	—
60	180 m	30 m	N/A ⁵	N/A ⁵	N/A ⁵	N/A ⁵	N/A ⁵	—	—	—	—	—	—
70	220 m	50 m	40 m	30 m	N/A ⁵	N/A ⁵	N/A ⁵	N/A ⁵	—	—	—	—	—
80	260 m	80 m	60 m	55 m	50 m	40 m	30 m	N/A ⁵	N/A ⁵	—	—	—	—
90	310 m	110 m	90 m	80 m	70 m	60 m	40 m	N/A ⁵	N/A ⁵	N/A ⁵	—	—	—
100	350 m	130 m	120 m	115 m	110 m	100 m	90 m	70 m	60 m	40 m	N/A ⁵	—	—
110	380 m	170 m	160 m	150 m	140 m	130 m	120 m	110 m	90 m	70 m	50 m	N/A ⁵	—
120	420 m	200 m	190 m	185 m	180 m	170 m	160 m	140 m	130 m	110 m	90 m	60 m	40 m
130	460 m	230 m	230 m	230 m	220 m	210 m	200 m	180 m	170 m	150 m	120 m	100 m	70 m

Notes:

¹ The distances are adjusted for a sign legibility distance of 50 m for Condition A. The distances for Condition B have been adjusted for a sign legibility distance of 75 m, which is appropriate for an alignment warning symbol sign.

² Typical conditions are locations where the road user must use extra time to adjust speed and change lanes in heavy traffic because of a complex driving situation. Typical signs are Merge and Right Lane Ends. The distances are determined by providing the driver a PIEV time of 14.0 to 14.5 seconds for vehicle maneuvers (2001 AASHTO Policy, Exhibit 3-3, Decision Sight Distance, Avoidance Maneuver E) minus the legibility distance of 50 m for the appropriate sign.

³ Typical condition is the warning of a potential stop situation. Typical signs are Stop Ahead, Yield Ahead, Signal Ahead, and Intersection Warning signs. The distances are based on the 2001 AASHTO Policy, Stopping Sight Distance, Exhibit 3-1, providing a PIEV time of 2.5 seconds, a deceleration rate of 3.4 m/second², minus the sign legibility distance of 50 m.

⁴ Typical conditions are locations where the road user must decrease speed to maneuver through the warned condition. Typical signs are Turn, Curve, Reverse Turn, or Reverse Curve. The distance is determined by providing a 2.5 second PIEV time, a vehicle deceleration rate of 3 m/second², minus the sign legibility distance of 75 m.

⁵ No suggested distances are provided for these speeds, as the placement location is dependent on site conditions and other signing to provide an adequate advance warning for the driver.

Source: Manual on Uniform Traffic Control Devices, 2003 Edition. Washington, DC: Federal Highway Administration, 2003.

Figure 13. Supplemental Advance Warning Signs

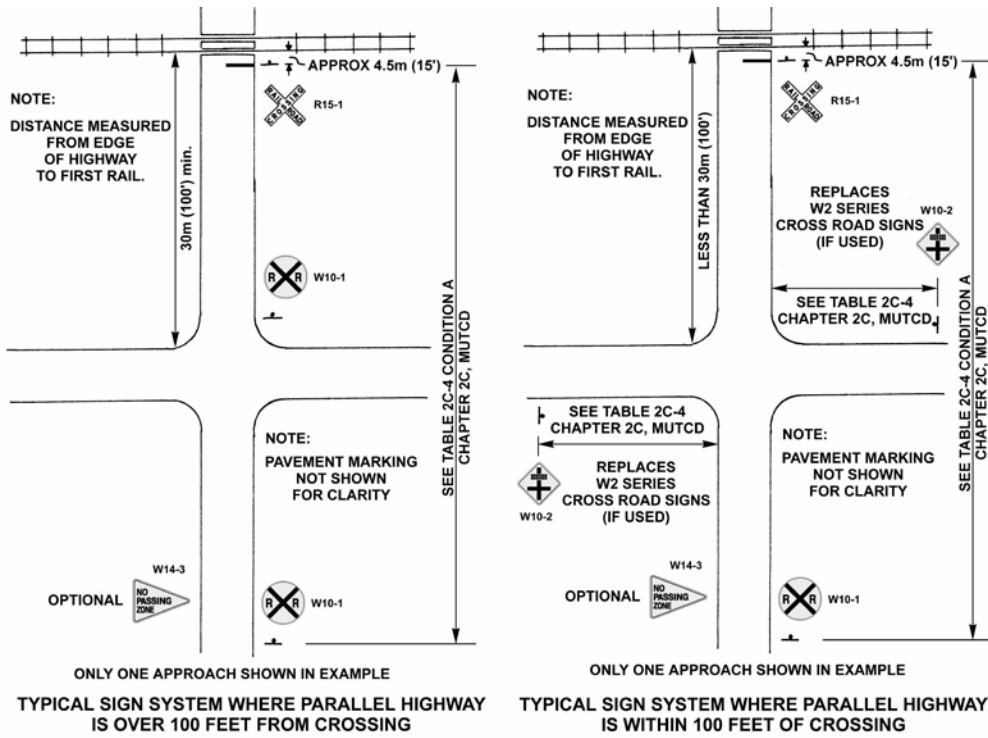
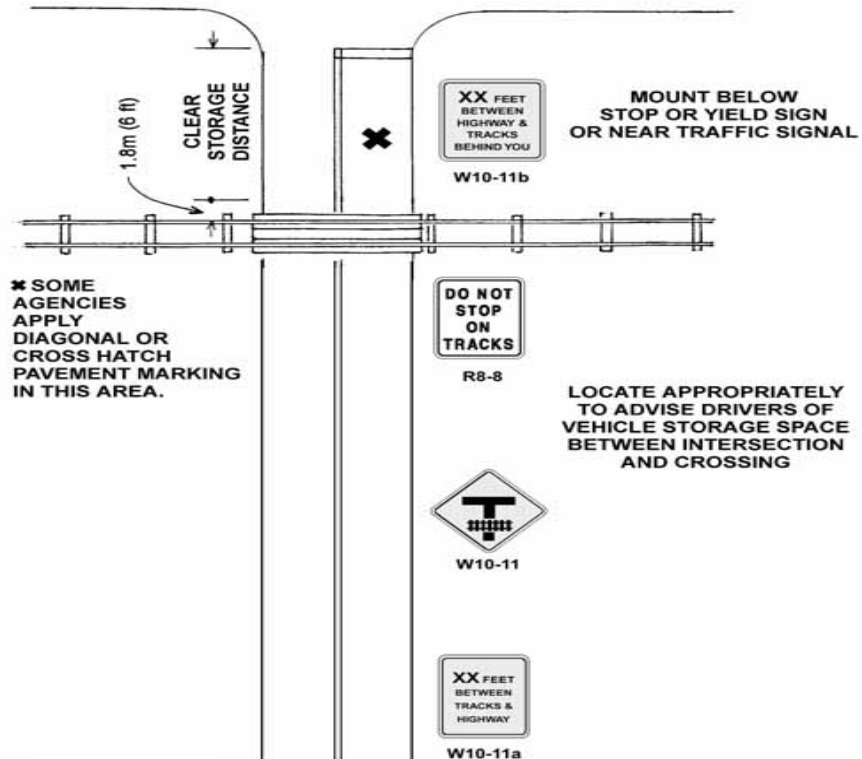
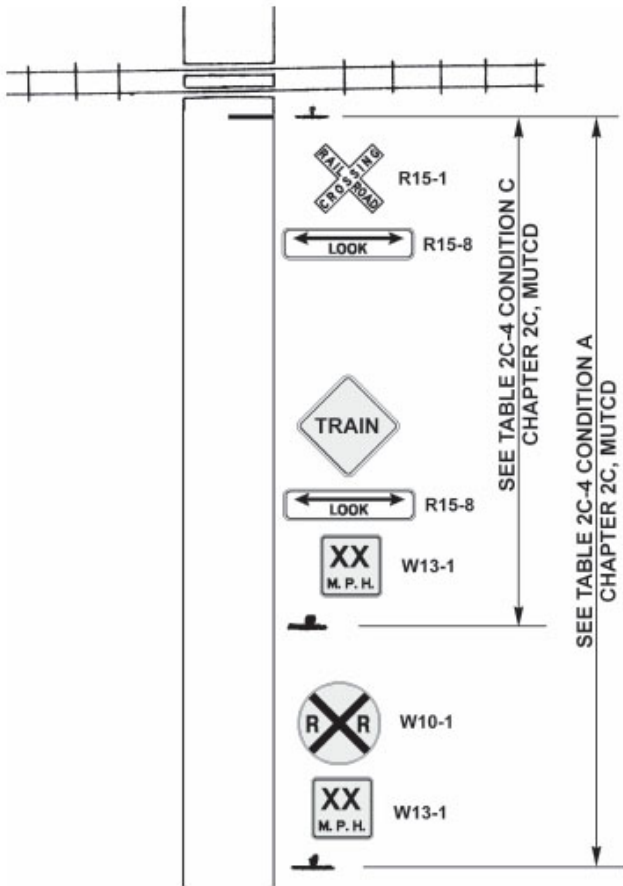

Figure 14. Substandard Clear Storage Distance



Source: Traffic Control Devices Handbook. Washington, DC: Institute of Transportation Engineers, 2001.

Figure 15. Possible Sign System Where Sight Distance Is Limited On Approach to the Crossing



Source: Traffic Control Devices Handbook. Washington, DC: Institute of Transportation Engineers, 2001.

Although the crossbuck sign is a regulatory sign that requires vehicles to yield to trains and stop if necessary, recent research indicates insufficient road user understanding of and compliance with that regulatory requirement when just the crossbuck sign is present at passive crossings. FHWA encourages consideration of the use of the YIELD sign in conjunction with the crossbuck sign at all passive crossings, except where train crews always provide flagging to roadway users. The STOP sign should be used at locations where engineering judgment determines it is appropriate. Figure 16 shows the typical layout, where STOP or YIELD signs are provided. For determination of the need for STOP or YIELD signs, refer to criteria provided in Chapter V of this handbook.

Figure 16. Typical Sign System Where STOP or YIELD at Crossing Is Required

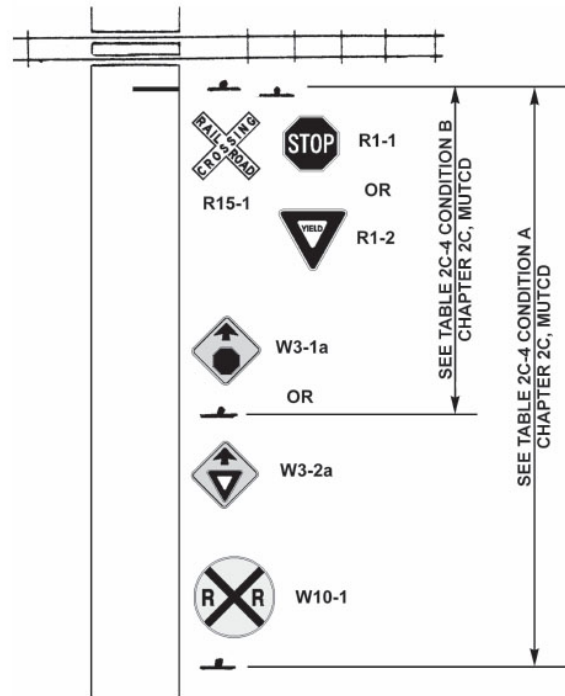

Source: Traffic Control Devices Handbook. Washington, DC: Institute of Transportation Engineers, 2001.

When used at a passive crossing, the YIELD or STOP sign shall be installed in conformance with the general principles and standards for sign installations in Part 2 and Part 8 of MUTCD. In addition, the following guidance can be considered for the installation of YIELD or STOP signs at passive crossings:

- When the YIELD or STOP sign is installed on the same support as the crossbuck sign, a strip of retroreflective material shall be used on the front and back of the support. The color of the retroreflective strip on the front of the support may be red (as per Section 2A.21) or white (as per Section 8B.03). The color of the retroreflective strip on the back of the support shall be white. The dimensions and placement of the retroreflective strips shall be in conformance with the standards in Section 8B.03.
- When a STOP sign is installed in conjunction with the crossbuck sign, a stop line should be installed, if appropriate to the roadway surface, to indicate the point behind which vehicles are required to stop, as per Section 3B.16.
- When a YIELD sign is used in conjunction with the crossbuck sign, either a yield line

Figure 17. Highway-Rail Grade Crossing (Crossbuck) Sign and STOP or YIELD Sign on Same Post

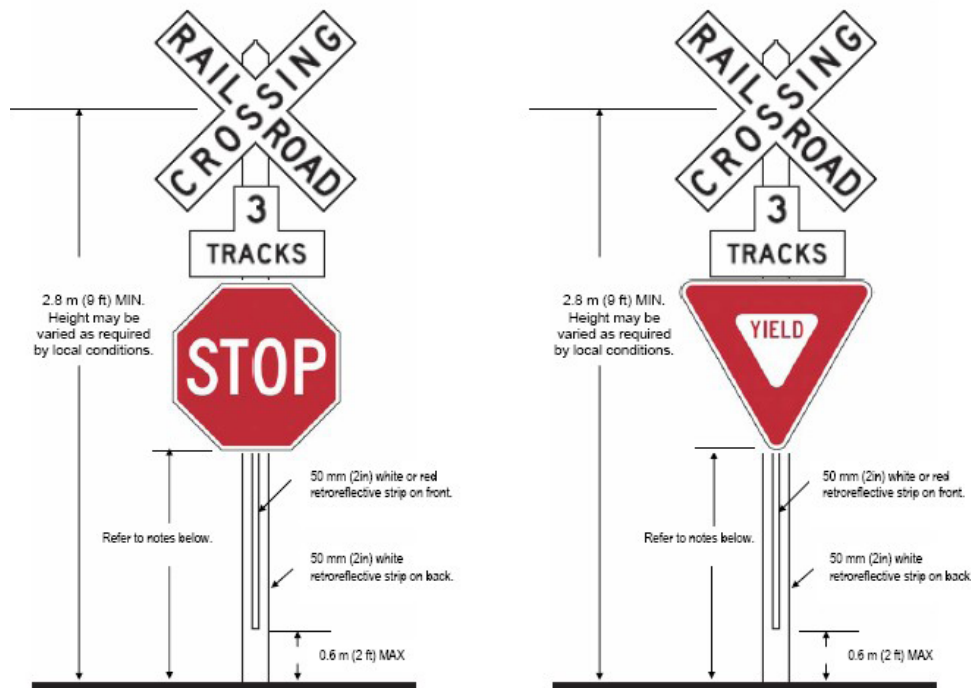

* Note: 1.2-meter (4-foot) minimum for installations of STOP or YIELD sign on existing crossbuck sign support; 2.1-meter (7-foot) minimum in areas with pedestrian movements or parking.

Source: Guidance for Use of YIELD or STOP Signs with the Crossbuck Sign at Passive Highway-Rail Grade Crossings. Memo issued by Jeffrey P. Paniati, Associate Administrator for Operations, and John R. Baxter, Acting Associate Administrator for Safety, Federal Highway Administration, Washington, DC, March 2006.

(per Section 3B.16) or a stop line (per Section 8B.21 and Figure 8B-6) may be installed to supplement the YIELD sign. When used, the stop line or yield line (such as size, pattern, and location) must be in conformance with provisions in the current edition of MUTCD.

- The stop line or yield line should be located no less than 4.6 meters (15 feet) measured perpendicular from the nearest rail, as per Figure 8B-6.

Examples of design and placement of YIELD or STOP signs in conjunction with crossbuck signs are shown in Figures 17 and 18.

“Stop Ahead” and “Yield Ahead” signs (W3-1 & W3-2). MUTCD also requires that “Stop Ahead” or “Yield Ahead” advance warning signs shall be installed if STOP or YIELD signs are used at the crossing and highway users do not have a continuous view of at least two sign faces for the distances specified in

MUTCD Table 4D-1 (see Tables 38 and 39.) If used, the placement of “Stop Ahead” or “Yield Ahead” advance signs shall be in accordance with MUTCD Table 2C-4 (refer to Tables 36 and 37.)

“Do Not Stop on Tracks” sign (R8-8). In accordance with MUTCD Section 8B.07, whenever engineering judgment determines that the potential for vehicles stopping on the tracks is high, a “Do Not Stop on Tracks” (R8-8) sign should be used. The sign, if used, should be located on the right side of the highway on either the near or far side of the highway-rail grade crossing, depending upon which side provides better visibility to approaching drivers. “Do Not Stop on Tracks” signs may be placed on both sides of the track. On divided highways and one-way streets, a second “Do Not Stop on Tracks” sign may be placed on the near or far left side of the highway-rail grade crossing to further improve visibility of the sign.

Figure 18. Highway-Rail Grade Crossing (Crossbuck) Sign and STOP or YIELD Sign on Separate Posts

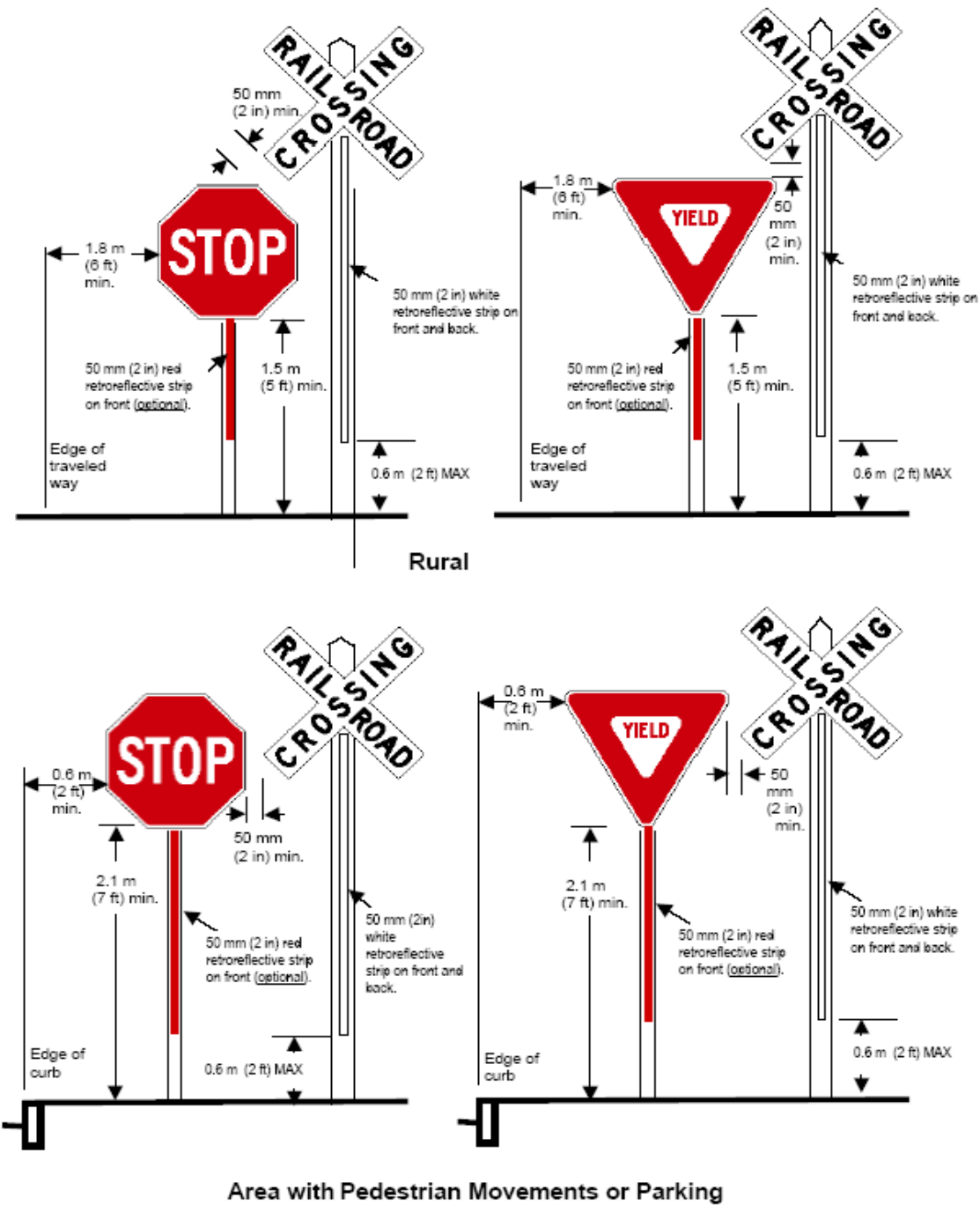

* Note: Place face of signs in the same plane and the YIELD or STOP sign closest to the traveled way; 50-millimeter (2-inch) minimum separation between the edge of the crossbuck sign and the edge of YIELD or STOP sign.

Source: Guidance for Use of YIELD or STOP Signs with the Crossbuck Sign at Passive Highway-Rail Grade Crossings. Memo issued by Jeffrey P. Paniati, Associate Administrator for Operations, and John R. Baxter, Acting Associate Administrator for Safety, Federal Highway Administration, Washington, DC, March 2006.

**Table 38. Minimum Sight Distance Table
(English Units)**

85 th -percentile speed (mph)	Minimum sight distance (feet)
20	175
25	215
30	270
35	325
40	390
45	460
50	540
55	625
60	715

Source: Manual on Uniform Traffic Control Devices, 2003 Edition.
Washington, DC: Federal Highway Administration, 2003.

**Table 39. Minimum Sight Distance Table
(Metric Units)**

85 th -percentile speed (km/hr.)	Minimum sight distance (meters)
30	50
40	65
50	85
60	110
70	140
80	165
90	195
100	220

Source: Manual on Uniform Traffic Control Devices, 2003 Edition.
Washington, DC: Federal Highway Administration, 2003.

“Exempt” sign (R15-3, W-10-1a). When authorized by law or regulation, a supplemental “Exempt” (R15-3) sign with a white background bearing the word EXEMPT may be used below the crossbuck sign or “Number of Tracks” sign, if present, at the highway-rail grade crossing, and a supplemental “Exempt” (W10-1a) sign with a yellow background bearing the word EXEMPT may be used below the highway-rail advance warning (W10-1) sign. These supplemental signs inform drivers of vehicles carrying passengers for hire, school buses carrying students, or vehicles carrying hazardous materials that a stop is not required at certain designated highway-rail grade crossings, except when a train, locomotive, or other railroad equipment is approaching or occupying the highway-rail grade crossing or the driver’s view is blocked.

Turn prohibition signs (R3-1a and R3-2a). Per MUTCD Section 8B.06, at a signalized intersection located within 60 meters (200 feet) of a highway-rail grade crossing, measured from the edge of the track

to the edge of the roadway, where the intersection traffic control signals are preempted by the approach of a train, all existing turning movements toward the highway-rail grade crossing should be prohibited during the signal preemption sequences. A blank-out or changeable message sign, and/or appropriate highway traffic signal indication or other similar type sign, may be used to prohibit turning movements toward the highway-rail grade crossing during preemption. The R3-1a and R3-2a signs shown in Figure 11 may be used for this purpose. Turn prohibition signs that are associated with preemption shall be visible only when the highway-rail grade crossing restriction is in effect.

“No Passing Zone” sign (W14-3). The “No Passing Zone” sign may be installed at crossings to supplement “No Passing” pavement markings. This sign consists of black letters and border on a yellow background and shall be a pennant-shaped isosceles triangle with its longer axis horizontal and pointing to the right with dimensions of 36 inches by 48 inches by 48 inches. The sign is to be placed on the left side of the highway at the beginning of the no passing zone.

2. Pavement Markings

Pavement markings are used to supplement the regulatory and warning messages presented by crossing signs and signals. Pavement markings have limitations in that they may be obliterated by snow, may not be clearly visible when wet, and may not be very durable when subjected to heavy traffic.

Pavement markings in advance of highway-rail grade crossings shall consist of an X, the letters RR, a NO PASSING marking for two-lane roads, and certain transverse lines, as shown in Figure 19. These pavement markings shall be placed on each approach lane on all paved approaches to crossings where crossing signals or automatic gates are located, and at all other crossings where the prevailing speed of highway traffic is 40 mph or greater. These markings are also to be placed at crossings where engineering studies indicate there is a significant potential conflict between vehicles and trains. These markings may be omitted at minor crossings or in urban areas if an engineering study indicates that other crossing devices provide suitable control. Figure 19 shows a placement example of warning signs and pavement markings at highway-rail grade crossings.

The most common pavement marking material is paint; however, a wide variety of other materials is available. Pavement markings are to be retroreflectorized by mixing glass beads in wet paint or thermoplastic material. Raised pavement markers can be used

Figure 19. Example of Placement of Warning Signs and Pavement Markings at Highway-Rail Grade Crossings

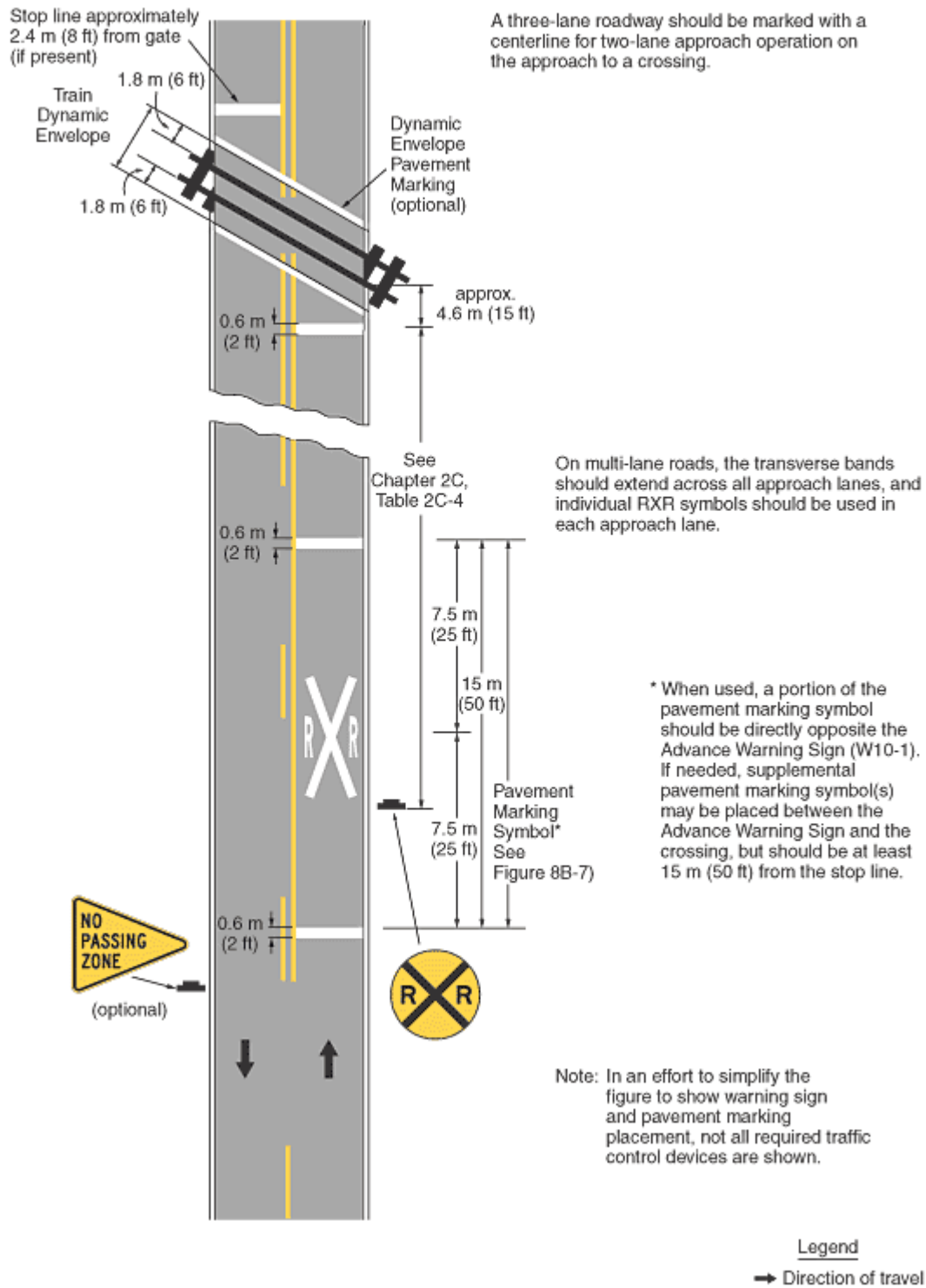

Source: Manual on Uniform Traffic Control Devices, 2003 Edition. Washington, DC: Federal Highway Administration, 2003.

to supplement pavement markings in advance of crossings. The "X" lane lines and the stop line can be delineated by raised retroreflective markers to provide improved guidance at night and during periods of rain and fog. Disadvantages of raised pavement markers include the initial cost and the possibility of being damaged or removed by snow plows.

All pavement markings are to be retroreflectorized white except for the NO PASSING markings that are to be retroreflectorized yellow. The stop line is to be 2 feet in width and extend across the approach lanes. The stop line should be located perpendicular to the highway centerline and approximately 15 feet from the nearest rail. Where automatic gates are installed, the stop line should be located approximately 8 feet in advance of where the gate arm crosses the highway surface. Figure 20 shows alternate pavement markings that place the paint out of the wheel path.

Transit Cooperative Research Program Report 69 recommends that the "Keep Clear" zone be striped with 0.15-meter (6-inch) white striping at a 45-degree angle to the roadway, with 1.5-meter (5-foot) separations between centerlines (see Figure 21,

which was developed from the Illinois Department of Transportation policy on pre-signals). It also recommends that the striping not continue over the railroad crossing panels, but it shall be continued between panels of multiple tracks. The report also recommends that, at skewed crossings where the angle between the diagonal stripes and the rail would be less than about 20 degrees, the stripes should be sloped in the opposite direction. Pavement marking shall conform to MUTCD, Part 3.⁸⁹

I. Active Traffic Control Devices

Active traffic control devices are those that give advance notice of the approach of a train. They are activated by the passage of a train over a detection circuit in the track, except in those few situations where manual control or manual operation is used. Active traffic control devices are supplemented with the

89 Korve, Hans W., Brent D. Ogden, Joaquin T. Siques, D. Mansel, et al. *Light Rail Service: Pedestrian and Vehicular Safety*. Washington, DC: Transit Cooperative Research Program Report 69, National Academy Press, 2001, p. 85-86.

Figure 20. Alternate Pavement Markings at Highway-Rail Grade Crossings

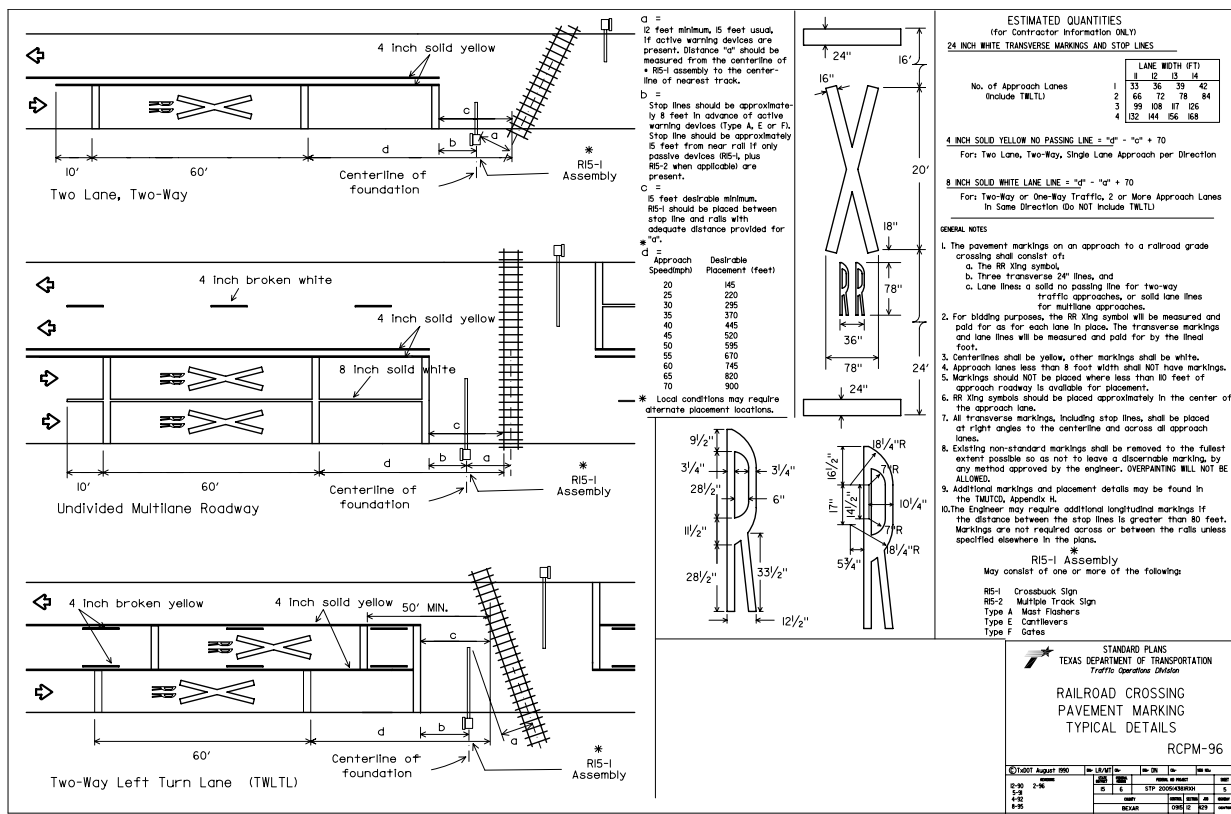

Source: Texas Department of Transportation.

Figure 21. Typical Supplemental Signing and Pavement Marking Treatment for Railroad Crossings
TYPICAL SUPPLEMENTAL SIGNING AND PAVEMENT MARKING TREATMENT FOR RAILROAD CROSSINGS

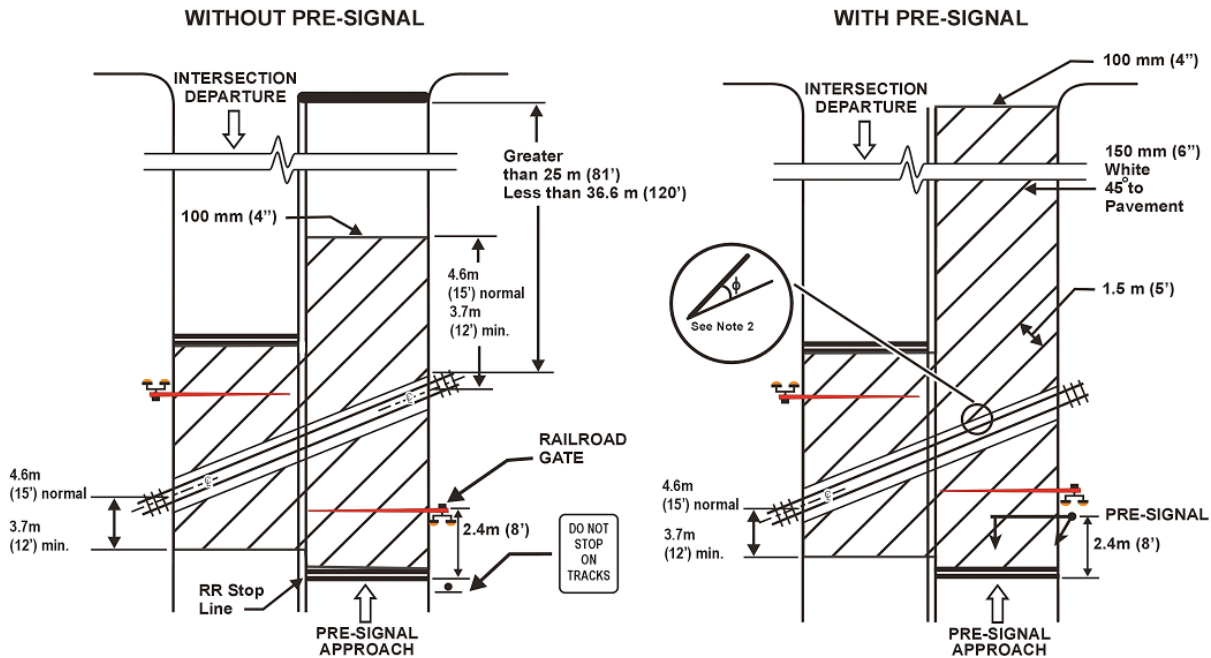

Note: 1. Pavement markings to be installed only on approaches to intersections controlled by traffic signals which are interconnected with the railroad warning signals.

2. Where the angle between the diagonal stripes and the track (ϕ) would be less than approximately 20° , the stripes should be sloped in the opposite direction from that shown.

NO SCALE

Source: Korve, Hans W., Brent D. Ogden, Joaquin T. Siques, D. Mansel, et al. Light Rail Service: Pedestrian and Vehicular Safety. Washington, DC: Transit Cooperative Research Program Report 69, National Academy Press, 2001, p. 85-86.

same signs and pavement markings used for passive control, except that STOP or YIELD signs shall not be used where active traffic control devices are installed. Active traffic control devices include flashing light signals (both mast-mounted and cantilevered), bells, automatic gates, active advance warning devices, and highway traffic signals. Also included in this section is a description of the various methods of train detection.

Driving tasks at crossings with active traffic control devices differ somewhat from those at crossings with passive devices. Passive devices indicate that a crossing is present and that a highway user must look for an approaching train and take appropriate action. At crossings with active traffic control devices, a motorist is told when a train is approaching. The motorist must take appropriate action when the devices are activated.

Crossing traffic control devices that are train activated normally incorporate some “fail-safe” design principles. The warning system is designed to give an indication of an approaching train whenever the system has failed.

Active traffic control devices have proven an effective method of improving safety and operations at highway-railroad grade crossings. Effectiveness is the percentage reduction in collisions due to a crossing improvement. Utilizing data contained in the U.S. DOT National Highway-Rail Crossing Inventory and the Railroad Accident/Incident Reporting System databases, effectiveness factors have been developed for active devices. The effectiveness factors are shown in Table 40 along with results obtained from a California study and a study by William J. Hedley covering 23 years of experience on the Wabash Railroad.

The effectiveness factors presented in Table 40 were developed from before-and-after collision crash experience of groups of crossings actually improved. The same effectiveness would not necessarily be experienced at any other crossing where the same improvements (changes) were made. It should be remembered that, in those studies, the crossings were selected for improvement by competent authorities as a precondition to performance of the work. Similar effectiveness could be anticipated under similar conditions.

Table 40. Effectiveness of Active Crossing Warning Devices

Category	Effectiveness Factors (Percent)		
	1980 U.S. DOT	1974 California	1952 Hedley
Passive to Flashing Lights	70	64	63
Passive to Automatic Gates	83	88	96
Flashing Lights to Automatic Gates	69	66	68

Source: Railroad-Highway Grade Crossing Handbook, Second Edition. Washington, DC: U.S. Department of Transportation, Federal Highway Administration, 1986.

The U.S. DOT Technical Working Group guidance document provides guidelines for selecting active devices (see Chapter V).

1. Flashing Light Signals

Flashing light signals consist of two light units that flash alternately at a rate of 45 to 65 times per minute. Thus, like their predecessor, the wigwag, they simulate a watchman swinging a red lantern. Wigwags consist of a single red light unit that sways back and forth.

The main components of a flashing light unit are the hood, background, roundel, lamp, lampholder reflector, and housing. The background is 20 or 24 inches in diameter and is painted a nonreflecting black to provide a contrast for the red light. The hood is also painted black.

Current standards call for the use of 12-inch diameter heads.

The roundel is red and comes in a variety of designs that direct the light toward the motorist. The "spreadlight" roundel distributes light through the entire angle, one-half the angle on each side of the beam axis. A deflecting roundel directs a portion of the light from the beam to one side of the axis in the direction indicated on the lens. A roundel having both spreadlight and deflecting features is designed so that the deflection is at a right angle to the spread. An example is the 3-degree horizontal deflection and 15-degree vertical spread. A roundel using a 20-degree spread and 32-degree downward deflection can be used on cantilevers. Back light units may use a 70-degree horizontal spread.

The lamp consists of a low-wattage bulb used to ensure operation on stand-by battery power should commercial power fail. The wattage most commonly used is 18 or 25 watts; however, some railroads use quartz iodide bulbs of 16 or 36 watts. The reflector, or mirror, is mounted behind the lamp and directs the light back through the roundel.

Figure 22. Typical Alignment Pattern for Flashing Light Signals with 30-15 Degree Roundel, Two-Lane, Two-Way Roadway

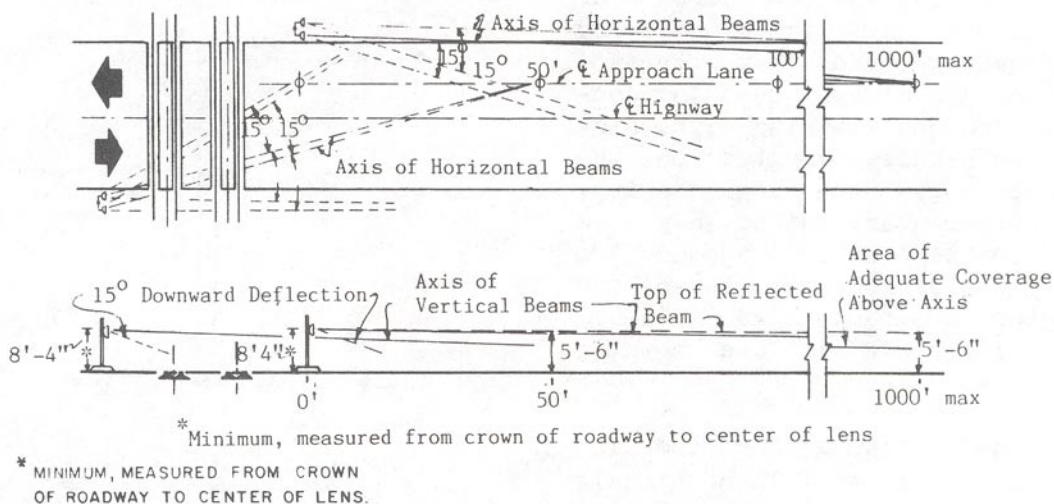

Source: Railroad-Highway Grade Crossing Handbook, Second Edition. Washington, DC: U.S. Department of Transportation, Federal Highway Administration, 1986.

Proper alignment of the light is essential. The lamp must be precisely aligned to direct the narrow intense beam toward the approaching motorist. The flashing light unit on the right-hand side of the highway is usually aligned to cover a distance far from the crossing. The light units mounted on the back of the signals on the opposing approach and, thus, on the left, are usually aligned to cover the near approach to the crossing. Figures 22 and 23 show typical alignment patterns for a two-lane, two-way highway and for a multilane highway.

Figure 23. Typical Alignment Pattern for Flashing Light Signals with 20-32 Degree Roundel, Multilane Roadway

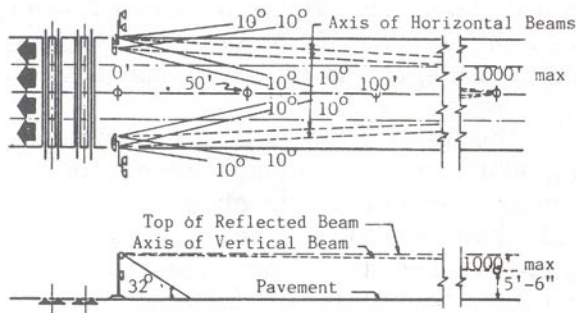

Source: Railroad-Highway Grade Crossing Handbook, Second Edition. Washington, DC: U.S. Department of Transportation, Federal Highway Administration, 1986.

MUTCD provides that when indicating the approach or presence of a train, the flashing light signal shall display toward approaching highway traffic two red lights mounted in a horizontal line and flashing alternately. Flashing light signals shall be placed to the right of approaching highway traffic on all highway approaches to a highway-rail grade crossing. They shall be located laterally with respect to the highway in conformance with Figure 24, except where such location would adversely affect signal visibility. At highway-rail grade crossings with highway traffic in both directions, back-to-back pairs of lights shall be placed on each side of the tracks. On multilane one-way streets and divided highways, flashing light signals shall be placed on the approach side of the highway-rail grade crossing on both sides of the roadway or shall be placed above the highway. A crossbuck is always used in conjunction with the flashing light signal and is usually mounted on the same post above the light units. Other supplementary signs may be mounted on the post, such as the “Do Not Stop on Tracks” sign (R8-8) and the “Number of Tracks” sign (R15-2). Flashing light signals are shown in Figures 25 and 26.

National warrants for the installation of flashing light signals have not been developed. Some states have established criteria based on exposure factors or priority indices. Other considerations include the following:

- Volume of vehicular traffic.
- Volume of railroad traffic.
- Speed of vehicular traffic.
- Speed of railroad traffic.
- Volume of pedestrian traffic.
- Collision record.
- Sight distance restrictions.

Specific criteria for the use of active warning devices such as flashing light assemblies are provided in the guidance document prepared by the U.S.DOT Technical Working Group (see Chapter V).

Post-mounted flashing light signals are normally located on the right side of the highway on all highway approaches to the crossing. Horizontal clearances for flashing light signals are discussed in the next section along with clearances for automatic gates.

2. Cantilevered Flashing Light Signals

Flashing light signals are generally post-mounted, but where improved visibility to approaching traffic is required, cantilevered flashing light signals are used. Cantilevered flashing lights may be appropriate when any of the following conditions exist:

- Multilane highways (two or more lanes in one direction).
- Highways with paved shoulders or a parking lane that would require a post-mounted light to be more than 10 feet from the edge of the travel lane.
- Roadside foliage obstructing the view of post-mounted flashing light signals.
- A line of roadside obstacles such as utility poles (when minor lateral adjustment of the poles would not solve the problem).
- Distracting backgrounds such as an excessive number of neon signs (conversely, cantilevered flashing lights should not distract from nearby highway traffic signals).
- Horizontal or vertical curves at locations where the extension of flashing lights over the traffic lane will provide sufficient visibility for the required stopping sight distance.

A typical installation consists of one pair of cantilevered lights on each highway approach, supplemented with a pair of lights mounted on the

Figure 24. Typical Clearances for Flashing Light Signals with Automatic Gates

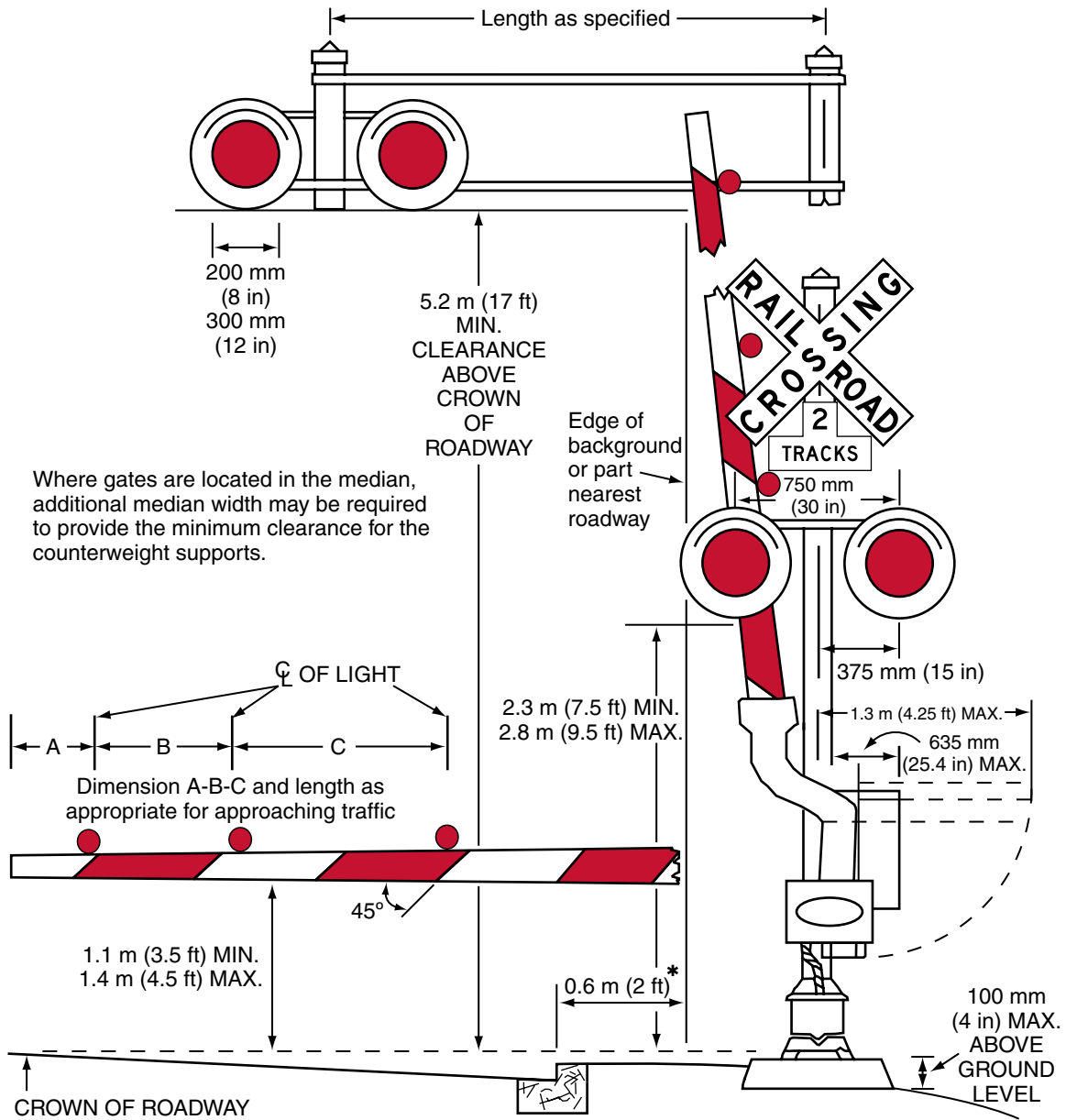

* For locating this reference line at other than curb section installation, see Section 8D.01.

* Note: At the January 2006 meeting of NCUTCD, the council approved a change that will require use of vertical red and white bands on crossing gate arms if incorporated into MUTCD.

Source: Manual on Uniform Traffic Control Devices, 2003 Edition. Washington, DC: Federal Highway Administration, 2003.

**Figure 25. Typical Flashing Light Signal—
Post Mounted**

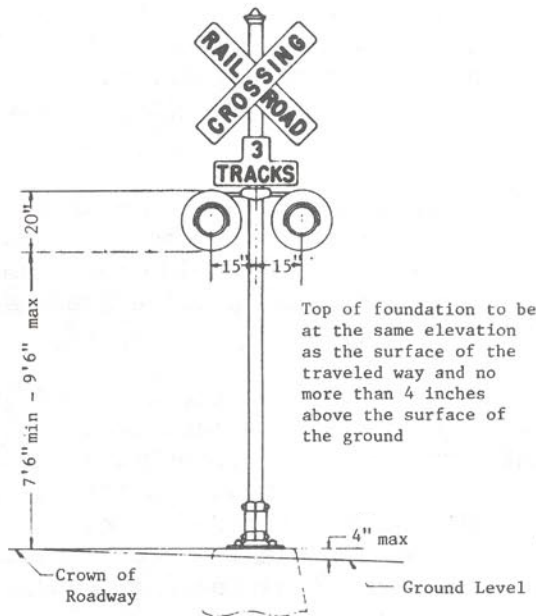

Source: Railroad-Highway Grade Crossing Handbook, Second Edition. Washington, DC: U.S. Department of Transportation, Federal Highway Administration, 1986.

**Figure 26. Typical Flashing Light Signal—
Cantilevered**

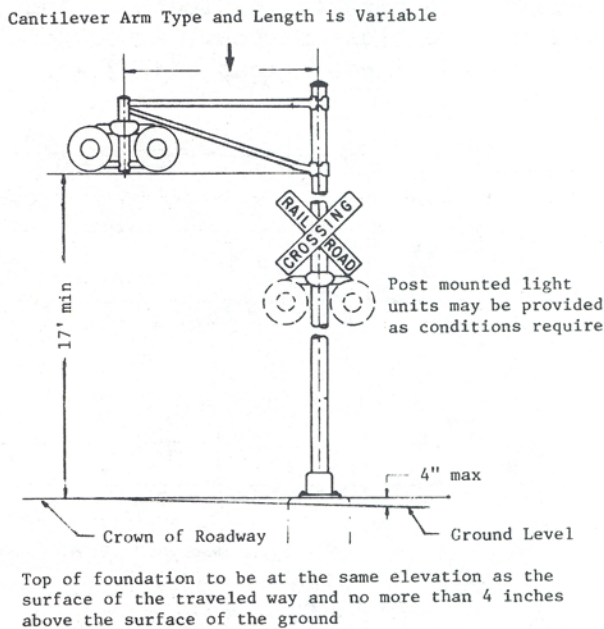

Source: Railroad-Highway Grade Crossing Handbook, Second Edition. Washington, DC: U.S. Department of Transportation, Federal Highway Administration, 1986.

supporting mast. However, two or more pairs of cantilevered flashing lights may be desirable for multilane approaches, as determined by an engineering study. The cantilevered lights can be placed over each lane so that the lights are mutually visible from adjacent driving lanes.

Cantilevers are available with fixed, rotatable, or walkout supports. The primary disadvantage of the fixed support is that maintenance of the light unit is usually performed from equipment in the traffic lane, thereby blocking highway traffic. Rotatable cantilevers can be turned to the side of the highway for maintenance but not for aligning the flashing lights.

Most current installations utilize walkout cantilevers. The inclusion of a ladder and access walkway allows for easier maintenance with less impact to highway traffic. Standard cantilevers for mounting flashing lights are made with arm lengths up to 40 feet. Where cantilever arm length in excess of 35 feet is required, a bridge structure is preferred.

3. Supplemental Flashing Light Signals

Additional pairs of light units may also be installed for side roads intersecting the approach highway near the crossing or for horizontal curves. Figure 27 shows the use of multiple pairs of lights to cover a horizontal curve to the left on the approach highway. A horizontal curve to the right may be covered by placing another roadside flashing light unit on the opposite side of the highway, as shown in Figure 28.

4. Light-Emitting Diode Flashing Light Signals

Light-emitting diode (LED) flashing light signal units may offer the following advantages over conventional incandescent lamps:

- Higher visibility at greater distances for in-line observations.
- Greater visibility on angles.
- Wider beam pattern and, therefore, easier beam alignment.
- Pure red signal with fast on-off transition, which improves conspicuity.
- Lower current consumption at nominal voltage, thereby suitable for solar-powered applications.
- Longer life expectancy.

Designers of LED systems should be aware of the voltage-current characteristics of the LED device they intend to use. The current versus voltage characteristic

Figure 27. Use of Multiple Flashing Light Signals for Adequate Visibility Horizontal Curve to the Left

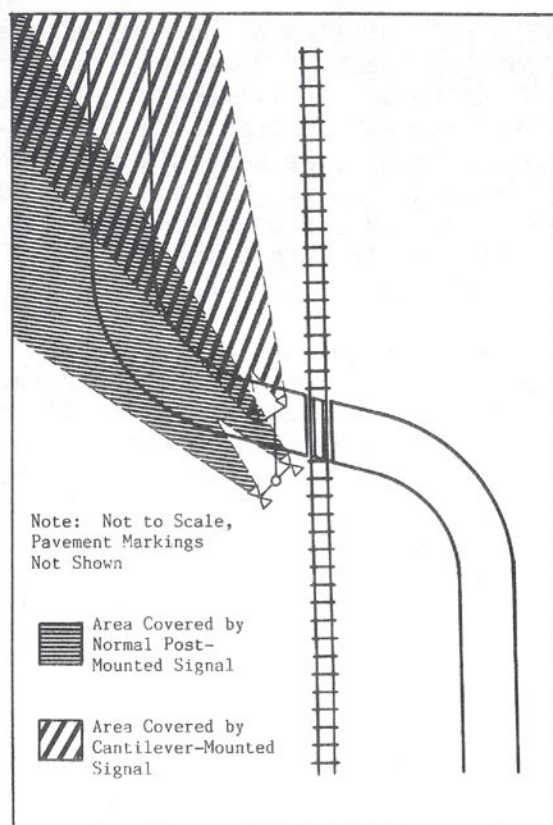
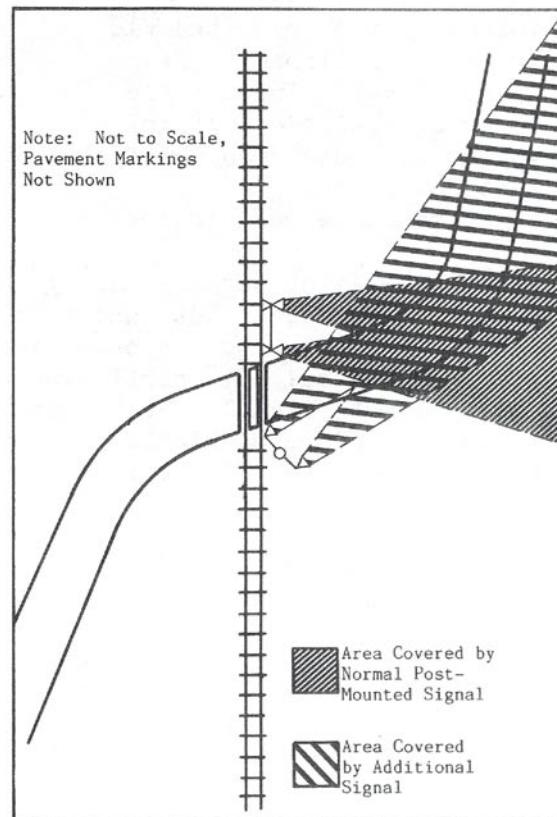

Figure 28. Use of Multiple Flashing Light Signals for Adequate Visibility Horizontal Curve to the Right



Source: Railroad-Highway Grade Crossing Handbook, Second Edition. Washington, DC: U.S. Department of Transportation, Federal Highway Administration, 1986.

of an incandescent lamp is relatively linear over the normal operating range. At 5 volts, a 10-volt, 25-watt incandescent lamp draws approximately 1.8 amps. At 12 volts, it may draw 2.8 amps. Users should be aware that the current consumption of LED signals is dependent on the design of the LED array. Some LED flashing light units are resistive and, at 12 volts, may draw three times the current drawn at 10 volts. Other brands of LED flashing light units have power supplies designed to compensate for lower voltages. These lamps may draw more current when the voltage is less than 10 volts, which is a realistic concern during power outages. To avoid damaging control circuits, which may result in dark signals, designers of LED flashing light signal circuits should consider the maximum current drawn by LED units over the expected voltage range.

5. Automatic Gates

An automatic gate serves as a barrier across the highway when a train is approaching or occupying the crossing. The gate is reflectorized with 16-inch diagonal

red and white stripes.⁹⁰ To enhance visibility during darkness, three red lights are placed on the gate arm. The light nearest to the tip burns steadily; the other two flash alternately. The gate is combined with a standard flashing light signal (see Figure 29 for a typical installation) that provides additional warning before the arm starts to descend, while the gate arm is across the highway, and until the gate arm ascends to clearance. The gate mechanism is either supported on the same post with the flashing light signal or separately mounted on a pedestal adjacent to the flashing light signal post.

In a normal sequence of operation, the flashing light signals and the lights on the gate arm in its normal upright position are activated immediately upon the detection or approach of a train. Industry standards require that the gate arm shall start its downward motion

⁹⁰ At the January 2006 meeting of the National Committee on Uniform Traffic Control Devices (NCUTCD), the council approved a change that will require use of vertical red and white bands on crossing gate arms if incorporated into the *Manual on Uniform Traffic Control Devices* (MUTCD).

not less than 3 seconds after the signal lights start to operate; shall reach its horizontal position before the arrival of the train; and shall remain in that position as long as the train occupies the crossing. When the train clears the crossing, and no other train is approaching, the gate arm shall ascend to its upright position normally in not more than 12 seconds, following which the flashing lights and the lights on the gate arm shall cease operation. In the design of individual installations, consideration should be given to timing the operation of the gate arm to accommodate slow-moving trucks.

In determining the need for automatic gates, the following factors may be considered:

- Multiple mainline railroad tracks.
- Multiple tracks where a train on or near the crossing can obscure the movement of another train approaching the crossing.
- High-speed train operation combined with limited sight distance.
- A combination of high-speed and moderately high-volume highway and railroad traffic.
- Presence of school buses, transit buses, or farm vehicles in the traffic flow.
- Presence of trucks carrying hazardous materials, particularly when the view down the track from a stopped vehicle is obstructed (curve in track, etc.).
- Continuance of collisions after installation of flashing lights.
- Presence of passenger trains.

In addition to the above factors, some states utilize a specified level of exposure or the priority index as a guideline for the selection of automatic gates.

The most recent criteria for the use of automatic gates are provided in the guidance document prepared by the U.S. DOT Technical Working Group (see Chapter V).

On two-way streets, the gates should cover enough of the approach highway to physically block the motorist from driving around the gate without going into the opposing traffic lane. On multilane divided highways, an opening of approximately 6 feet may be provided for emergency vehicles.

Gates may be made of aluminum, fiberglass, or wood. Fiberglass or aluminum gates may be designed with a breakaway feature so that the gate is disengaged from the mechanism when struck. The American Railway Engineering and Maintenance-of-Way Association (AREMA) *Communications and Signal Manual* sets a limit of 38 feet for the gate length. Some railroads request reconfiguration of the crossing when gate arm

lengths would exceed 32 feet and it may be necessary to place gate assemblies in the median to cover the approach highway. In these cases, crash cushions or other safety barriers may be desirable. Under no circumstances should signals or gate assemblies be placed in an unprotected painted median. Conversely, some railroads would prefer longer gate arms rather than a gate mechanism in the median. A typical clearance plan for a flashing light signal with automatic gate is shown in Figure 24.

When no train is approaching or occupying the crossing, the gate arm is held in a vertical position and the minimum clearance from the face of the vertical curb to the nearest part of the gate arm or signal is 2 feet, for a distance of 17 feet above the highway. Where there is no curb, a minimum horizontal clearance of 2 feet from the edge of a paved or surfaced shoulder is required, with a minimum clearance of 6 feet from the edge of the traveled highway. Where there is no curb or shoulder, the minimum horizontal clearance from the traveled way is 6 feet. Where flashing lights or gates are located in the median, additional width may be required to provide the minimum clearances for the counterweight support.

The lateral location of flashing light and gate assemblies must also provide adequate clearances from the track as well as space for construction of the foundations. Figure 29 shows typical locational requirements for the foundations for flashing lights and cantilevered flashing lights with gates. The area for the foundation and excavation must be analyzed to determine the effect on sidewalks, utility facilities, and drainage. Although these plans indicate a 12-foot minimum clearance between the center of the flashing light assembly and the center of the tracks, some railroads prefer a 15-foot minimum clearance.

Figures 30 through 36 show typical location plans for flashing light signals with and without gates. If it is necessary to locate the supporting post in a potentially hazardous position to ensure adequate visibility, some type of safety barrier should be considered. These are discussed in a later section.

It should be noted that gate arms have a maximum standard length of 11.6 meters (38 feet). Some railroads prefer to limit arm lengths to 9.75 meters (32 feet). In addition, FRA requires that the gate arm cover 90 percent of the approach lane; a 7.3-meter (24-foot) gate arm would be required to control two 3-meter (10-foot) lanes if mounted with the center of the mast 1.5 meters (5 feet) back from the face of curb. Clearly, large multilane intersections and intersections with unusual configurations will require careful study

Figure 29. Typical Location of Signal Devices

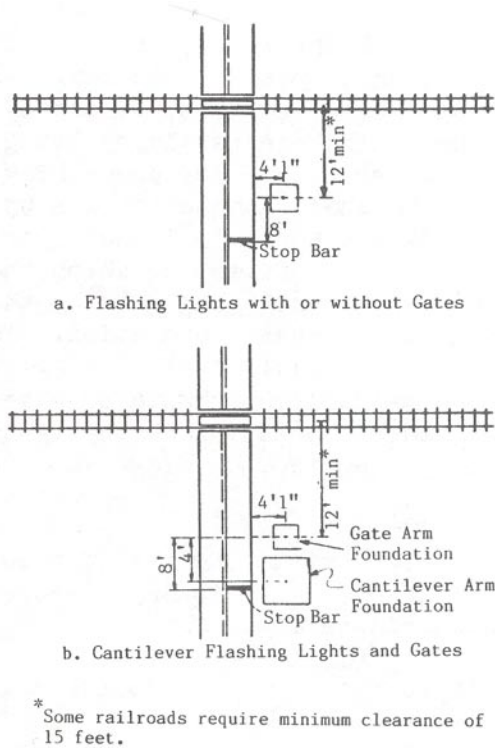

Source: Railroad-Highway Grade Crossing Handbook, Second Edition. Washington, DC: U.S. Department of Transportation, Federal Highway Administration, 1986.

to determine the appropriate layout of crossing gate locations. For such conditions, gate arm requirements may become a principal factor in the layout of the intersection geometry and channelization from the outset. The crossing gate (and, therefore, traffic control) treatment should be an integral part of the design of an intersection, not an afterthought.

6. Four-Quadrant Gates

Four-quadrant gate systems consist of a series of automatic flashing light signals and gates in which the gates extend across both the approach and the departure side of roadway lanes. Unlike two-quadrant gate systems, four-quadrant gates provide additional visual constraints and inhibit nearly all traffic movements over the crossing after the gates have been lowered.

At this time, only a small number of four-quadrant gate systems have been installed in the United States, and they incorporate different types of designs to prevent vehicles from being trapped between the gates. In some installations, the exit gates are delayed to allow roadway vehicles to clear before the crossing is secured; other systems include vehicle presence detection to hold the exit gates up while vehicles are within the crossing zone.

Four-quadrant gates are recognized as a supplemental safety measure under the Final Rule for quiet zones (refer to Chapter II, Section B.) It should be noted that FRA has assigned a lower effectiveness to installations that include vehicle presence detection because the act of raising the exit gates may allow vehicles to enter the crossing. On the other hand, the California Public Utilities Commission, which has modified its General Orders to address use of four-quadrant gates, requires installation of a vehicle presence system “subject to a Commission staff diagnostic field meeting recommendation and an engineering study performed by railroad or local road agencies.”⁹¹

Figure 30. Typical Location Plan, Right Angle Crossing, One-Way, Two Lanes

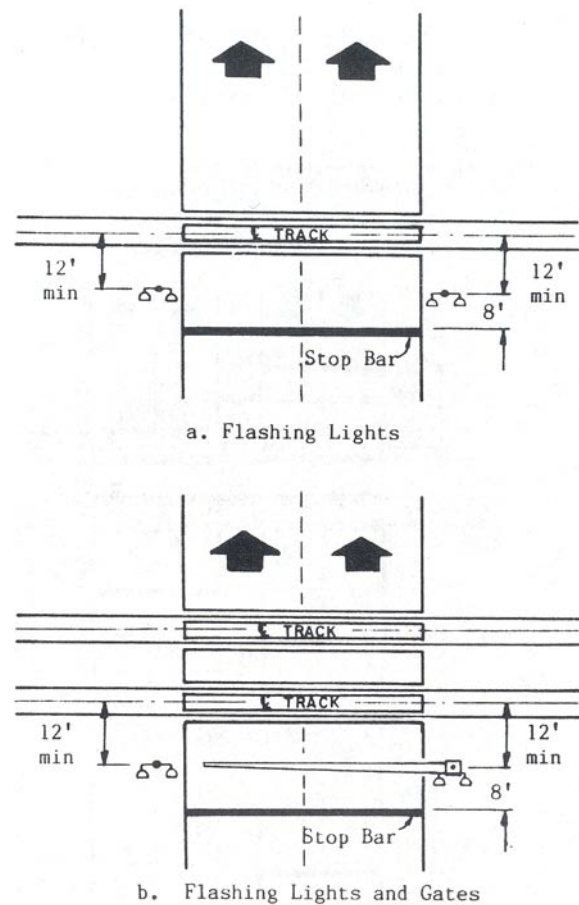

Note: Two gate arms may be used as an alternate.

Source: Railroad-Highway Grade Crossing Handbook, Second Edition. Washington, DC: U.S. Department of Transportation, Federal Highway Administration, 1986.

91 “Regulations Governing the Protection Of Crossings At Grade Of Roads, Highways And Streets With Railroads In The State Of California.” Section 6.71 (www.cpuc.ca.gov/word_pdf/GENERAL_ORDER/20555.doc).

Figure 31. Typical Location Plan, Right Angle Crossing, One-Way, Three Lanes

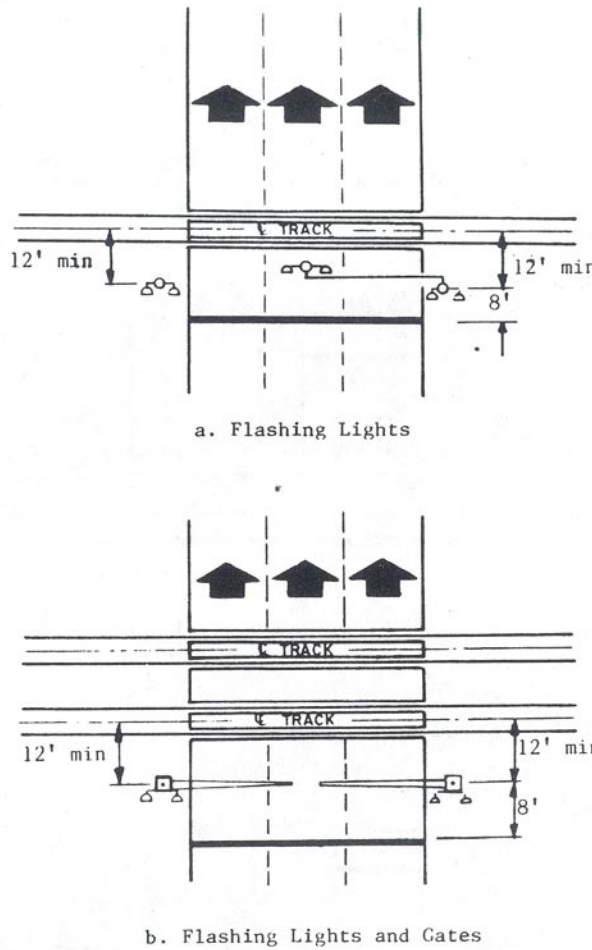
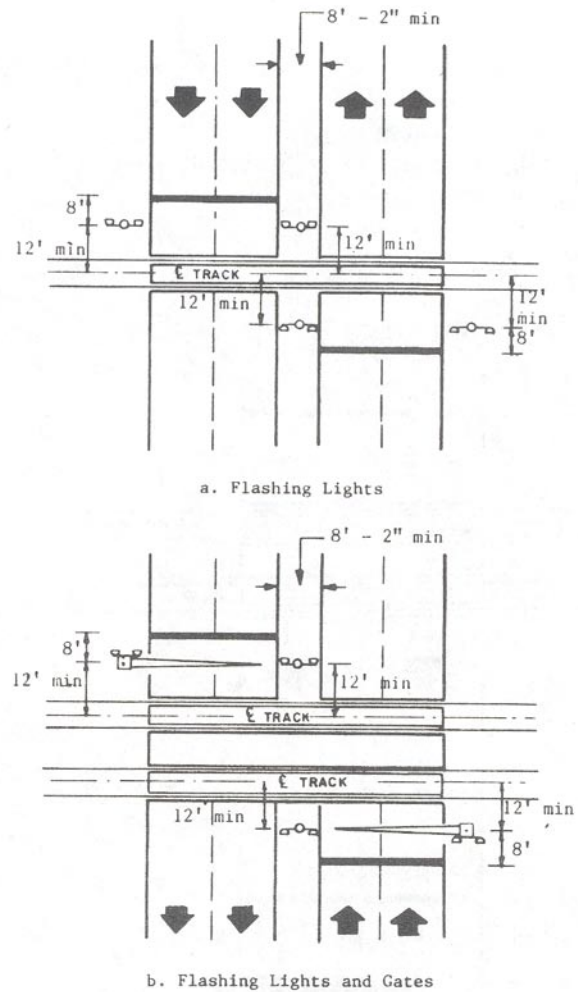

Figure 32. Typical Location Plan, Divided Highway with Signals in Median, Two Lanes Each Way



Source: Railroad-Highway Grade Crossing Handbook, Second Edition. Washington, DC: U.S. Department of Transportation, Federal Highway Administration, 1986.

7. Use of Channelization with Gates

Despite the dangers of crossing in front of oncoming trains, drivers continue to risk lives and property by driving around crossing gates. At many crossings, drivers are able to cross the centerline pavement marking and drive around a gate with little difficulty. The number of crossing gate violations can be reduced by restricting driver access to the opposing lanes. Highway authorities have implemented various median separation devices, which have shown a significant reduction in the number of vehicle violations at crossing gates.

Limitations are common to the use of any form of traffic separation at highway-rail grade crossings. These include restricting access to intersecting streets, alleys, and driveways within the limits of the median, and possible adverse safety effects. The median should

Note: The median width of 8'2" is an operation requirement and is not an AASHTO recommendation for median width.

Source: Railroad-Highway Grade Crossing Handbook, Second Edition. Washington, DC: U.S. Department of Transportation, Federal Highway Administration, 1986.

be designed to allow vehicles to make left turns or U-turns through the median where appropriate, based on engineering judgment and evaluation.

It should be noted that median treatments meeting the requirements of 49 CFR 222 are considered supplemental safety measures by FRA for use in a quiet zone (refer to Chapter II, Components of a Highway-Rail Grade Crossing).

Various styles of median treatments include barrier wall systems, wide raised medians, and mountable raised curb systems.

Figure 33. Typical Location Plan, Divided Highway with Signals in Median, Three Lanes Each Way

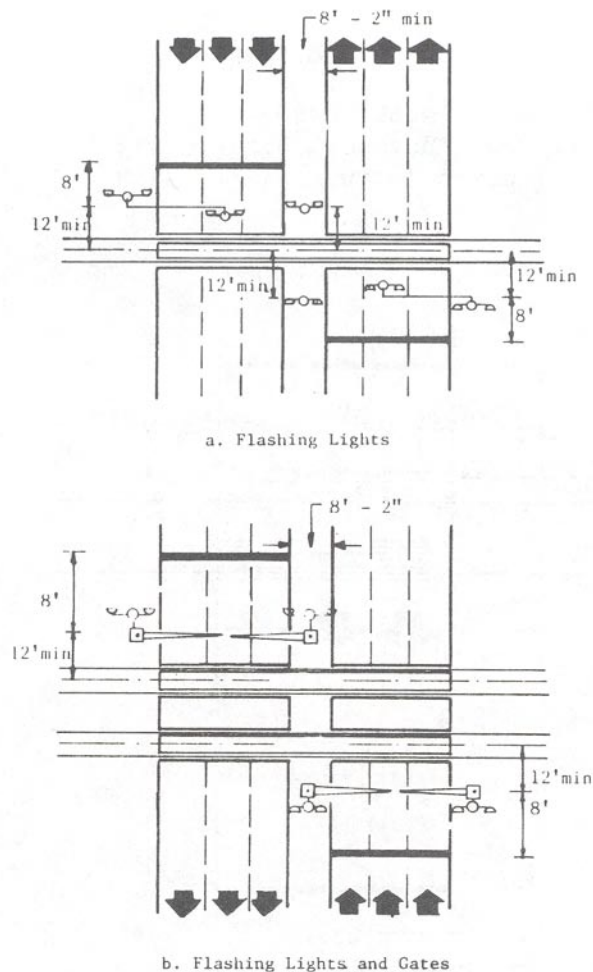

Note: The median width of 8'2" is an operation requirement and is not an AASHTO recommendation for median width.

Source: Railroad-Highway Grade Crossing Handbook, Second Edition. Washington, DC: U.S. Department of Transportation, Federal Highway Administration, 1986.

Barrier wall systems. Concrete barrier walls and guardrails generally prevent drivers from crossing into opposing lanes throughout the length of the installation. In this sense, they are the most effective deterrent to crossing gate violations. However, the road must be wide enough to accept the width of the barrier and the appropriate end treatment. Sight restrictions for vehicles with low driver eye heights and any special needs for emergency vehicles to make a U-turn maneuver should be considered (but not for the purpose of circumventing the traffic control devices at the crossing). Installation lengths can be more effective if they extend beyond a minimum length of 46 meters (150 feet).

Figure 34. Typical Location Plan, Divided Highway with Insufficient Median for Signals, Two Lanes Each Way

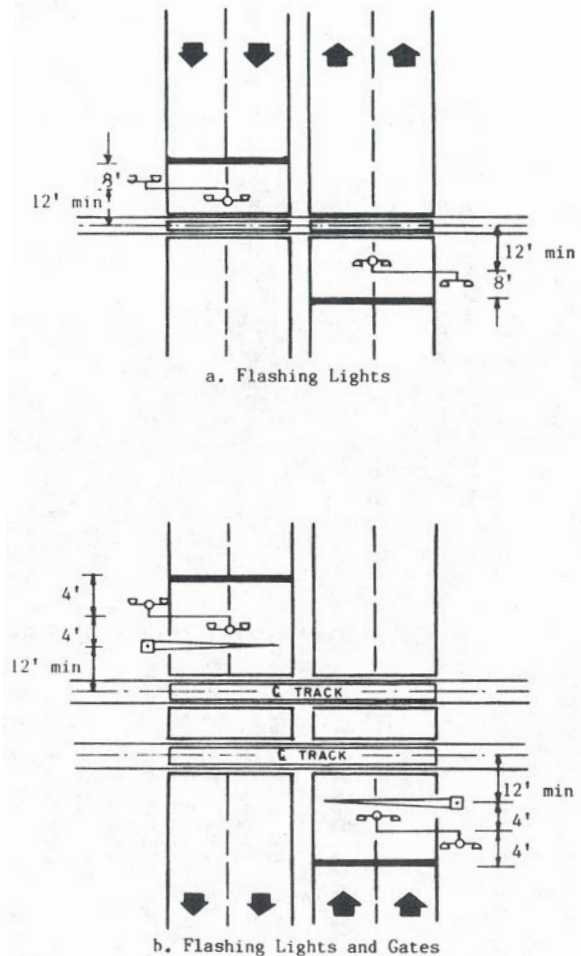

Source: Railroad-Highway Grade Crossing Handbook, Second Edition. Washington, DC: U.S. Department of Transportation, Federal Highway Administration, 1986.

Wide raised medians. Curbed medians generally range in width from 1.2 to more than 30 meters (4 to 100 feet). Although they do not present a true barrier, wide medians can be nearly as effective because a driver would have significant difficulty attempting to drive across to the opposing lanes. The impediment becomes more formidable as the width of the median increases. A wide median, if attractively landscaped, is often the most aesthetically pleasing separation method.

Drawbacks to implementing wide raised medians include the availability of sufficient right of way and the maintenance of surface and/or landscape. Additions such as trees, flowers, and other vegetation higher than .9 meter (3 feet) above the roadway can restrict drivers' view of approaching trains. Maintenance

Figure 35. Typical Location Plan, Acute Angle Crossing for Divided Highway with Signals in Median, Two or Three Lanes Each Way

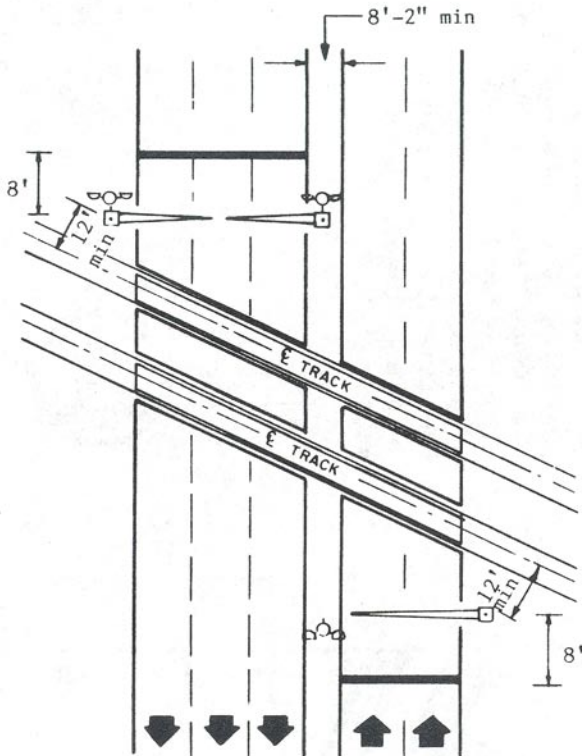

Note: The median width of 8'2" is an operational requirement and is not an AASHTO recommendation for median width.

Source: Railroad-Highway Grade Crossing Handbook, Second Edition. Washington, DC: U.S. Department of Transportation, Federal Highway Administration, 1986.

can be expensive, depending on the treatment of the median. Limitation of access can cause property owner complaints, particularly for businesses. Non-mountable curbs can increase the total crash rate and the severity of collisions when struck by higher-speed vehicles (greater than 64 km/hr. (40 mph)).

Non-mountable curb islands. Non-mountable curb islands are typically 6 to 9 inches in height and at least .6 meter (2 feet) wide and may have reboundable, reflectorized vertical markers. Drivers have significant difficulty attempting to violate these types of islands because the 6- to 9-inch heights cannot be easily mounted and crossed.

Some disadvantages should be considered. The road must be wide enough to accommodate a 2-foot median. The increased crash potential should be evaluated. AASHTO recommends that special attention be given to high visibility if such a narrow device is used in higher-speed (greater than 64 km/hr. (40 mph))

Figure 36. Typical Location Plan, Obtuse Angle Crossing for Divided Highway with Signals in Median, Two or Three Lanes Each Way

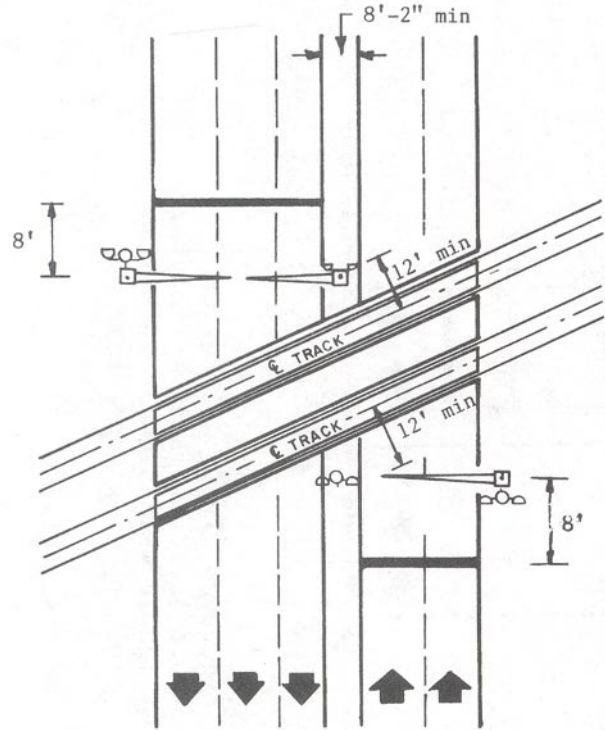

Note: The median width of 8'2" is an operational requirement and is not an AASHTO recommendation for median width.

Source: Railroad-Highway Grade Crossing Handbook, Second Edition. Washington, DC: U.S. Department of Transportation, Federal Highway Administration, 1986.

environments. Care should be taken to assure that an errant vehicle cannot bottom-out and protrude into the oncoming traffic lane. Sight restrictions for low driver eye heights should be considered if vertical markers are installed. Access requirements should be fully evaluated, particularly allowing emergency vehicles to cross opposing lanes (but not for the purpose of circumventing the traffic control devices at the crossing). Paint and reflective beads should be applied to the curb for night visibility.

The state of Illinois has developed a standard that uses a combination of mountable and non-mountable curbs to provide a wide raised median with escape zones both in the median as well as to the shoulder (see Figure 37).

Mountable raised curb systems. Mountable raised curb systems with reboundable vertical markers present drivers with a visual impediment to crossing to the opposing traffic lane. The curbs are no more than 6

Figure 37. Example of Combination of Mountable and Non-Mountable Curbs from Illinois Department of Transportation

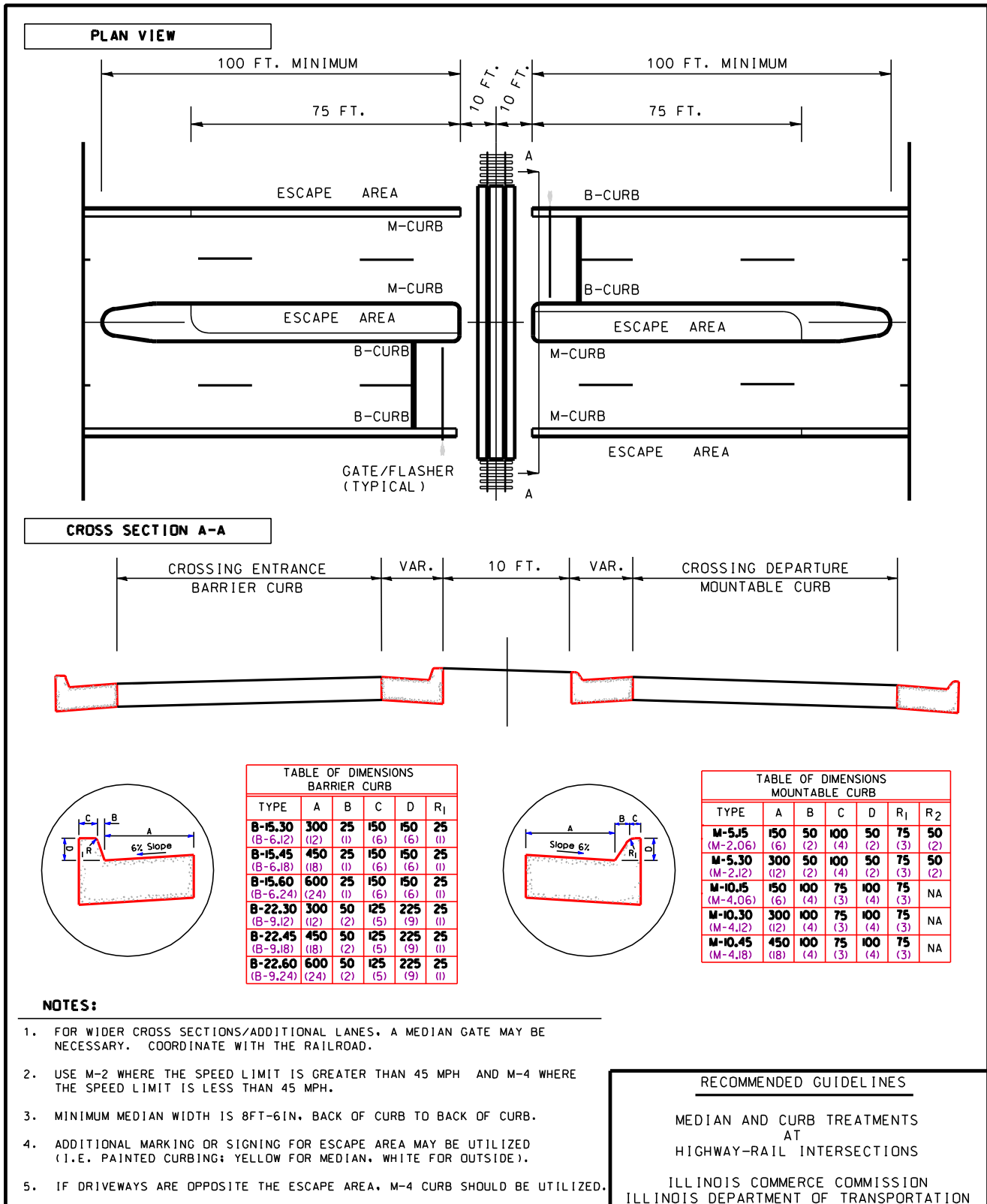

Source: Illinois Department of Transportation.

inches in height, less than 12 inches in width, and built with a rounded design to create minimal deflection upon impact. When used together, the mountable raised median and vertical delineators discourage passage. These systems are designed to allow emergency vehicles to cross opposing lanes (but not for the purpose of circumventing the traffic control devices at the crossing). Usually, such a system can be placed on existing roads without the need to widen them.

Because mountable curbs are made to allow emergency vehicles to cross and designed to deflect errant vehicles, they also are the easiest of all the barriers and separators to violate. Large, formidable vertical markers will inhibit most drivers. Care should be taken to assure that the system maintains its stability on the roadway with design traffic conditions and that retroreflective devices or glass beads on the top and sides of the curb are maintained for night visibility. Curb colors should be consistent with the location and direction of traffic adjacent to the device.⁹²

These devices have proven a low-cost investment with a high rate of return in safety at crossings. The separators are installed along the centerline of roadways, in most cases extending approximately 20 to 30 meters (70 to 100 feet) from the crossing. They prevent motorists from crossing lanes to “run around” activated crossing gates. The separators consist of prefabricated, mountable islands made of a composite material. Attached to the islands are flat delineator panels or tubes with reflectorized taping for better visibility at night. The delineator panels are flexible yet securely anchored to return to their original positions if struck by a vehicle.

The use of median separators at the Sugar Creek Road crossing in the North Carolina Sealed Corridor Program has resulted in a 77-percent reduction in crossing violations. The use of median separators in conjunction with four-quadrant gates has produced a 98-percent reduction in crossing violations. Also being installed, especially in conjunction with roadway widening projects, are concrete median separators with tubular markers mounted on them.⁹³

8. Barrier Gate

The barrier gate is a movable automatic gate designed to close an approaching roadway temporarily at a

highway-rail crossing. A typical installation includes a housing containing electromechanical components that lower and raise the gate arm, the arm itself, and a locking assembly bolted to a concrete foundation to receive and hold the lowered gate arm in place. The barrier gate arm itself has been installed with a system consisting of three steel cables, the top and bottom of which are enclosed aluminum tubes.

Barrier devices should at least meet the evaluation criteria for a National Cooperative Highway Research Program (NCHRP) Report 350 (Test Level 2) attenuator; stopping an empty, 4,500-pound pick-up truck traveling at 70 km/hr. (43 mph). Barrier gates have been tested to safely stop a pick-up truck traveling at 72 km/hr. (45 mph) and have been installed in Madison, Wisconsin and Santa Clara County, California.

Barrier gates could be applied to situations requiring a positive barrier, such as in a down position, closing off-road traffic, and opening only on demand. FRA rules require consideration of barrier and/or enhanced warning systems subject to FRA approval for operation over 110 mph. FRA has indicated that a barrier gate, if equipped with monitoring and confirmation as required by the Final Rule, may be applicable to enforce a nighttime closure for partial quiet zones.

9. Warning Bell

A crossing bell is an audible warning device used to supplement other active traffic control devices. A bell is most effective as a warning to pedestrians and bicyclists.

When used, the bell is usually mounted on top of one of the signal support masts. The bell is usually activated whenever the flashing light signals are operating. Bell circuitry may be designed so that the bell stops ringing when the lead end of the train reaches the crossing. When gates are used, the bell may be silenced when the gate arms descend to within 10 degrees of the horizontal position. Silencing the bell when the train reaches the crossing or when the gates are down may be desired to accommodate residents of suburban areas.

10. Wayside Horn System

The wayside horn system consists of a horn or series of horns located at the highway-rail grade crossing and directed at oncoming motorists. The system is designed on fail-safe principles and provides a means to verify sound output. The wayside horn system:

⁹² *Guidance on Traffic Control Devices at Highway-Rail Grade Crossings*. Washington, DC: FHWA, Highway/Rail Grade Crossing Technical Working Group, November 2002.

⁹³ North Carolina Department of Transportation Sealed Corridor Program Website, “Median Separators” (www.bytrain.org/safety/sealed.html).

Figure 38. Example of Location Plan for Flashing Light Signals and Four-Quadrant Gates

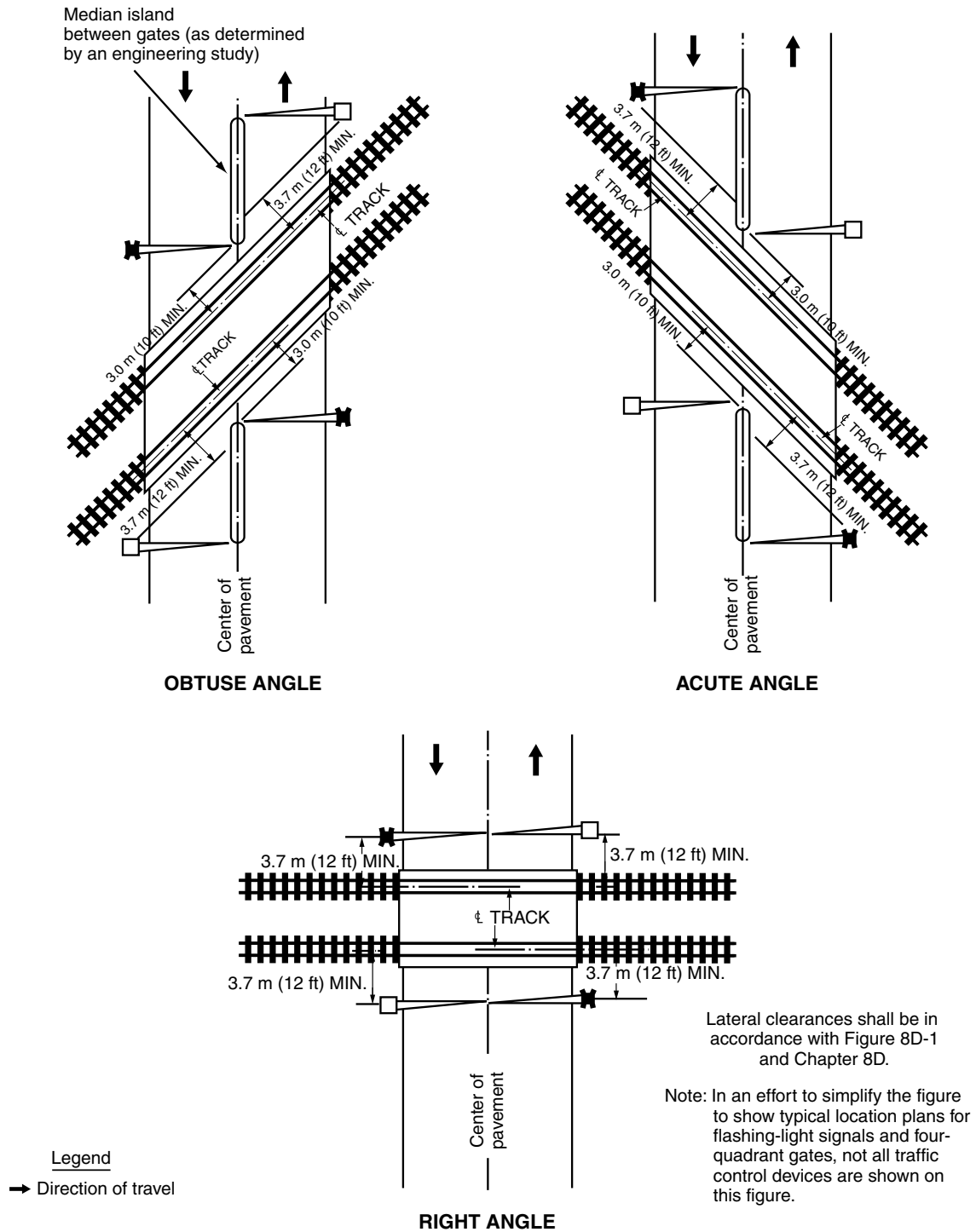

Source: Manual on Uniform Traffic Control Devices, 2003 Edition. Washington, DC: Federal Highway Administration, 2003.

- Simulates the sound and pattern of a train horn.
- Provides similar (or safer) response from road users.
- Minimizes the audible impact on individuals located near the highway-rail grade crossing.

The purpose of the wayside horn system is to focus the horn sound level on the road user while minimizing the noise impact adjacent to the railroad from the point the train horn is required to be sounded.

The system is used as an adjunct to train-activated warning systems to provide audible warning of an approaching train for traffic on all approaches to the highway-rail grade crossing. It is not required to direct the wayside horn system toward approaching roadway users from roadways adjacent to the railroad if the roadway users' movements toward the crossing are controlled by a STOP sign or traffic signal.

When a wayside horn system is used at highway-rail grade crossings where the locomotive-mounted horn is not sounded, the highway-rail grade crossings must be equipped with flashing lights and gates and constant warning circuitry, where practical. In such instances, the wayside horn should also provide a "confirmation" indication to the locomotive engineer; in the absence of a confirmation signal, the engineer would need to activate the locomotive-mounted horn.

The wayside horn system simulates a train horn and sounds at a minimum of 15 seconds prior to the train's arrival at the highway-rail grade crossing, or simultaneously with the activation of the flashing lights or descent of the gate, until the lead locomotive has traversed the crossing. Where multiple tracks are present, the wayside horn system is immediately reactivated when another train is detected before the previous train clears the crossing. Wayside horn systems should include a 3- to 5-second delay after activation of flashing lights signals before sounding.

At its June 2006 meeting, the NCUTCD council approved a proposed new section to Part 8 of MUTCD to recognize use of the wayside horn either as a supplemental audible device or as an alternative to the sounding of a locomotive-mounted horn. The council also approved new language for Part 10, which allows use of the wayside horn for light rail. The text in Part 10 would allow a wayside horn to be used to reproduce

the tone and sound level of wayside equipment. This would allow use of directional horns in lieu of traditional crossing bells at locations with light rail not subject to FRA jurisdiction, such as urban light-rail crossings.

11. Active Advance Warning Sign

The active advance warning sign (AAWS) consists of one or two 12-inch yellow hazard identification beacons mounted above the advance warning sign, as shown in Figure 39. An advisory speed plate sign indicating the safe approach speed also should be posted with the sign.⁹⁴ The AAWS provides motorists with advance warning that a train is approaching the crossing. The beacons are connected to the railroad track circuitry and activated on the approach of a train. The AAWS should continue to be activated until the crossing signals have been deactivated.

Figure 39. Examples of Active Advance Warning Signs and Cantilevered Active Advance Warning Sign

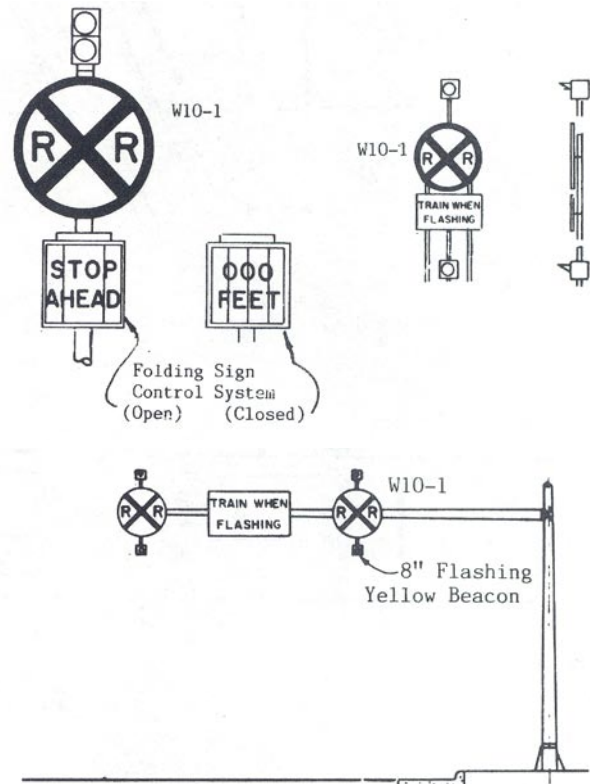

Source: Railroad-Highway Grade Crossing Handbook, Second Edition. Washington, DC: U.S. Department of Transportation, Federal Highway Administration, 1986.

94 *Guidance on Traffic Control Devices at Highway-Rail Grade Crossings*. Washington, DC: FHWA, Highway/Rail Grade Crossing Technical Working Group, November 2002.

A train-activated advance warning sign should be considered at locations where the crossing flashing light signals cannot be seen until an approaching motorist has passed the decision point (the distance from the track from which a safe stop can be made). Use of the AAWS may require some modification of the track circuitry. Consideration should be given to providing a back-up source of power in the event of commercial power failure.

AAWS is sometimes supplemented with a message, either active or passive, that indicates the meaning of the device, such as “Train When Flashing.” A passive supplemental message remains constant; an active supplemental message changes when the device is activated by the approach of a train.

To allow the traffic queue at the crossing time to dissipate safely, the advance flashers should continue to operate for a period of time after the active control devices at the crossing deactivate, as determined by an engineering study.

If such an advance device fails, the driver would not be alerted to the activated crossing controls. If there is concern for such failure, some agencies use a passive “Railroad Signal Ahead” sign to provide a full-time warning message. The location of this supplemental advance warning sign is dependent on vehicle speed and the geometric conditions of the roadway.

AAWS should be placed at the location where the advance warning sign would normally be placed. To enhance visibility at crossings with unusual geometry or site conditions, the devices may be cantilevered or installed on both sides of the highway. An engineering study should determine the most appropriate location.

12. “Second Train Coming” Active Warning Sign

Train detection systems can also be used to activate a “Train Coming” supplemental warning sign. This sign is used on a limited basis, normally near commuter stations where multiple tracks and high volumes of pedestrian traffic are present. The sign will activate when a train is located within the crossing’s approach circuits and a second train approaches the crossing. It is also being evaluated at multiple-track highway-rail grade crossings as a supplement to automatic gates. Because this sign is not currently in MUTCD, any jurisdictions wishing to use symbols to convey any part of this message must request permission to experiment

from FHWA.⁹⁵ (Refer to Chapter X, Special Issues, for use of the “Second Train Coming” pedestrian device as well as the “Train Coming” icon active warning sign used at LRT crossings.)

13. Active Turn Restriction Signs

At a signalized intersection located within 60 meters (200 feet) of a highway-rail grade crossing, measured from the edge of the track to the edge of the roadway, where the intersection traffic control signals are preempted by the approach of a train, all existing turning movements toward the highway-rail grade crossing should be prohibited during the signal preemption sequences.

A blank-out or changeable message sign and/or appropriate highway traffic signal indication or other similar type sign may be used to prohibit turning movements toward the highway-rail grade crossing during preemption.⁹⁶

14. New Traffic Signals

During the time this handbook was being updated, NCUTCD and FHWA were considering a proposal to amend MUTCD to include a new traffic signal warrant that would apply, under certain conditions, to highway-highway intersections in close proximity to highway-railroad grade crossings.

The proposed warrant under consideration is specifically intended to apply to situations in which:

- A major roadway runs more or less parallel to a line of railroad, and a minor roadway intersects both the major roadway and the line of railroad at grade.
- The resulting highway-highway intersection does not otherwise meet any of the other currently approved traffic signal warrants in MUTCD.
- Motorist compliance with the existing (passive) traffic control devices at the highway-highway intersection often results in highway vehicles queuing across or fouling the nearby highway-railroad grade crossing.
- Other strategies to mitigate such queuing/fouling are deemed impractical, inappropriate, or not feasible.

When applied, any traffic signals installed pursuant to

⁹⁵ Ibid.

⁹⁶ *Manual on Uniform Traffic Control Devices, 2003 Edition*. Washington, DC: FHWA, 2003.

this new warrant would also need to include provisions for railroad preemption (for example, if not already existing, some means of automatically detecting a train approaching the highway-railroad grade crossing would also need to be provided), to allow for clearing any queued vehicles off the grade crossing prior to the arrival of a train.

Draft language proposing the new warrant was approved by the National Council at the June 2006 meeting of NCUTCD. This proposed warrant or some version thereof is likely to be included in a formal Notice of Proposed Amendment to MUTCD, which is currently expected to be issued by FHWA in late 2007 or early 2008. A Final Rule formally including it in MUTCD is expected to be issued in 2009.

15. Preemption of Traffic Signals

Where a signalized highway intersection exists in close proximity to a railroad crossing, the railroad and traffic signal control equipment should be interconnected, and the normal operation of the traffic signals controlling the intersection should be preempted to operate in a special control mode when trains are approaching (see MUTCD Sections 8D.07 and 10D.05). A preemption sequence compatible with railroad crossing active traffic control devices is extremely important to provide safe vehicular and pedestrian movements. Such preemption serves to ensure that the actions of these separate traffic control devices complement rather than conflict with each other. The text beginning on the next page incorporates key provisions of a recommended practice prepared by the Institute of Transportation Engineers (ITE).⁹⁷

16. Train Detection

To serve their purpose of advising motorists and pedestrians of the approach or presence of trains, active traffic control devices are activated by some form of train detection. Generally, the method is automatic and requires no personnel to operate it, although a small number of such installations are operated under manual control. The automatic method uses the railroad circuit. This electrical circuit uses the rails as conductors in such a way that the presence of a solid electrical path, as provided by the wheels and axles of a locomotive or railroad car, shunts the circuit. The system is also designed to be fail-safe; that is, any shunt of the circuit,

whether by railroad equipment, vandalism, or an “open circuit,” such as a broken rail or track connection, causes the crossing signals to be activated.

Standard highway traffic signals display a green, yellow, or red light at all times except when power has failed and the signals are dark. Crossing signals are normally dark unless a train is approaching or occupying the crossing. There is no indication to the highway user when power has failed. Therefore, crossing control systems are designed to also operate on stand-by battery power should commercial power be terminated for any reason. Solar energy may be used to charge storage batteries to power signals at crossings in remote locations.

Storage battery stand-by power is provided to span periods of commercial power failure. The stand-by assures normal operation of crossing signals during a commercial power outage. When this practice was initiated, the crossing signals were normally supplied with AC power through a step-down transformer. The same AC source provided charging current through a rectifier for the stand-by battery to maintain the battery in a charged condition. When commercial AC power failed, crossing signal power connections were transferred from the AC source to the battery, as shown in Figure 45. This arrangement was necessary because the “constant current” rectifiers used in this service were unable to respond to changes in battery voltage or load.

Present day “constant voltage” rectifiers can respond to changes in battery voltage and load and can provide high DC current to the battery and load during periods when crossing signals are energized, tapering off quickly as soon as stand-by battery capacity has been replenished after the crossing signals are de-energized. This ability of modern rectifiers permits DC operation of the signals whether AC supply voltage is present or not. The signals are connected directly to battery terminals and the power transfer is eliminated, as shown in Figure 40.

On tracks where trains operate at speeds of 20 mph or higher, the circuits controlling automatic flashing light signals shall provide for a minimum operation of 20 seconds before the arrival of any train. This 20-second warning time is a minimum. The warning time should be of sufficient length to ensure clearance of a vehicle that might have stopped at the crossing and then proceeded to cross just before the flashing lights began operation. Some railroads use a warning time of 25 seconds at crossings with automatic gates. Factors that can affect this time include the width of the crossing, the length and acceleration capabilities

⁹⁷ *Preemption of Traffic Signals Near Railroad Crossings: An ITE Recommended Practice*. Prepared by Traffic Engineering Council Committee TENC-99-06. Washington, DC: Institute of Transportation Engineers, 2006.

PREEMPTION OF TRAFFIC SIGNALS NEAR RAILROAD CROSSINGS

The traffic engineer designing the preemption system must understand how the traffic signal controller unit operates in response to a call for a preemption sequence. The engineer must consult with railroad personnel who are responsible for railroad signal design and operations to ensure that appropriate equipment is specified and that both highway and railroad signal installations operate properly and with full compatibility. Continuous cooperation between highway and railroad personnel is essential for safe operation. Important information concerning the type of railroad signal equipment that can be used is available from the operating railroad and from the AREMA *Communications and Signal Manual*. In addition, state and local regulations should be consulted.

Preemption of traffic signals for railroad operations is very complex and must be designed and operated for a specific location, often with unique conditions. With the extremely large number of variables involved, it is difficult to simply quantify all the time and distance elements. The goal of this recommended practice is to identify as many elements as possible and provide references where feasible. Recommendations are therefore provided in the generic sense, with the expectation that applications will be designed for local conditions. The list of conditions requiring preemption is not intended to be complete but should provide an awareness of the factors necessitating preemption of normal traffic signal operation.

When to preempt. If either of the two conditions listed below prevails, consideration should be given to interconnecting traffic signals on public and private highways with active warning devices at railroad crossings:

- Highway traffic queues have the potential for extending across a nearby rail crossing; or
- Traffic backed up from a nearby downstream railroad crossing could interfere with signalized highway intersections.

A crossing equipped with a passive control device may need to be upgraded to include active warning devices so that preemption of the traffic signal can be implemented effectively. Such improvements are particularly important when the tracks are close to the signalized intersection or when certain conditions exist, such as high-speed train or highway approaches; tracks in highway medians; geometry such as steep grades; or special vehicles using the crossing, such as trucks carrying hazardous material or school buses.

Where a crossing with active control devices is in close proximity to a STOP-sign controlled intersection, it may be necessary to consider the installation of traffic signals to clear queues from the crossing if an engineering study indicates that other solutions or traffic control devices will not be effective.

When designing a preemption system, many important items should be considered. These include distance between the tracks and signal; intersection and crossing geometry; approach speed of trains and vehicles; train frequency; vehicle flow rates; vehicle size and classification; and operation of the traffic signal controller unit.

Traffic approaching the intersection from the tracks—long distance. The 1948 edition of MUTCD stipulated the interconnection of traffic signals to crossings with “flashers, wigwags or gates” within about 500 to 1,000 feet (150 to 300 meters). The 1961 edition of MUTCD shortened the recommended distance to about 200 feet (65 meters), except under unusual conditions, and added the term “preemption.” Although this value seems subjective, it has been retained in succeeding editions of MUTCD (including the Millennium Edition) and is referenced by several other publications. Research, however, has found this distance inadequate. The current edition of MUTCD also mentions that coordination with the flashing light system should be considered for traffic signals located farther than 200 feet (60 meters) from the crossing.¹ Coordination could include, for example, queue detection that would omit some signal phases or activate variable message signs.

Where possible, field observations of traffic queue lengths during critical traffic periods can provide guidance on the need for signal preemption. Queue arrival and dissipation studies should be made during peak travel

¹ *Manual on Uniform Traffic Control Devices, 2003 Edition*. Washington, DC: FHWA, 2003.

demand times at the site. Where field observation is not possible because the crossing is not yet in full operation, some intersection capacity analysis computer programs that provide an estimate of queue lengths can be used to determine whether the 95th-percentile queue from the signalized intersection will extend as far as the railroad crossing.

A simple but reasonably reliable estimate of 95th-percentile queue lengths (queues that will not be exceeded 95 percent of the time) can be calculated as:

Equation 1

$$L = 2qr(1+p)25$$

where:

- L = length of queue (feet)
- q = vehicle flow rate (vehicles per lane per second)
- r = effective red time (red + yellow) (seconds)
- p = proportion of heavy vehicles in traffic flow (as a decimal)

The factor of 25 represents the effective length of a passenger car (vehicle length plus space between vehicles); the factor of 2 is a random arrival factor.

Equation 1 provides a good estimate of queue lengths where the volume-to-capacity ratio (v/c) of the signalized intersection is less than 0.90. However, for v/c ratios greater than 0.90, some overflow queues could occur as a result of fluctuations in arrival rates. To compensate for this condition, it is suggested that one vehicle be added to the estimated queue length for each 1-percent increase in the v/c ratio over 0.90. Accordingly, in cases where the v/c ratio ranges between 0.90 and 1.0, the following equation applies:

Equation 2

$$L = 2qr(1+\Delta x)(1+p)(25)$$

where:

$$\Delta = 100 (v/c \text{ ratio} - 0.90)$$

For a v/c ratio of 0.95, for example, $\Delta = 5$. Equation 2 cannot be used reliably if the v/c ratio is greater than 1.0—for example, if the intersection is oversaturated. Under these conditions, a *Highway Capacity Manual* analysis or traffic simulation model may be useful alternatives.²

It is not the intent of either MUTCD or the queue calculation equation to provide a specific distance as the sole criterion to interconnect railroad and highway signals. Special consideration should be given where upstream signals cause vehicles to arrive in platoons that could result in long queue lengths. Unusual 15-minute peak-period flow rates should be evaluated. Vehicle classification studies should be performed, because trucks must be factored separately, and some trucks may have unusual size and operating characteristics.^{3,4} Similar locations may be evaluated for comparative vehicle queuing.

In some cases, observed and/or predicted queues may be so long that preemption, even if provided, may not be adequate for vehicles to clear the tracks. In these circumstances, additional anti-queuing measures are available.

² *Highway Capacity Manual*. Washington, DC: Transportation Research Board, National Research Council, 2000.

³ Harwood, D.W. "Traffic and Vehicle Operating Characteristics." In *Traffic Engineering Handbook*. Washington, DC: Institute of Transportation Engineers (ITE), 1992.

⁴ *Mandatory Stops at Railroad Grade Crossings, Appendix E*. U.S. DOT, FHWA, Report FHWA/RD/86/014, 1986.

Traffic approaching the intersection from the tracks—short distance. Where the clear storage distance between the crossing and the highway intersection stop line is not sufficient to safely store a design vehicle (typically the longest legal truck combination), or if vehicles regularly queue across the tracks, a pre-signal should be considered. An engineering study should be performed to support this recommendation. The concept is illustrated in Exhibit 1. A pre-signal should also be considered if gates are not present. See the following section for additional information regarding the application and design of pre-signals.

Exhibit 1

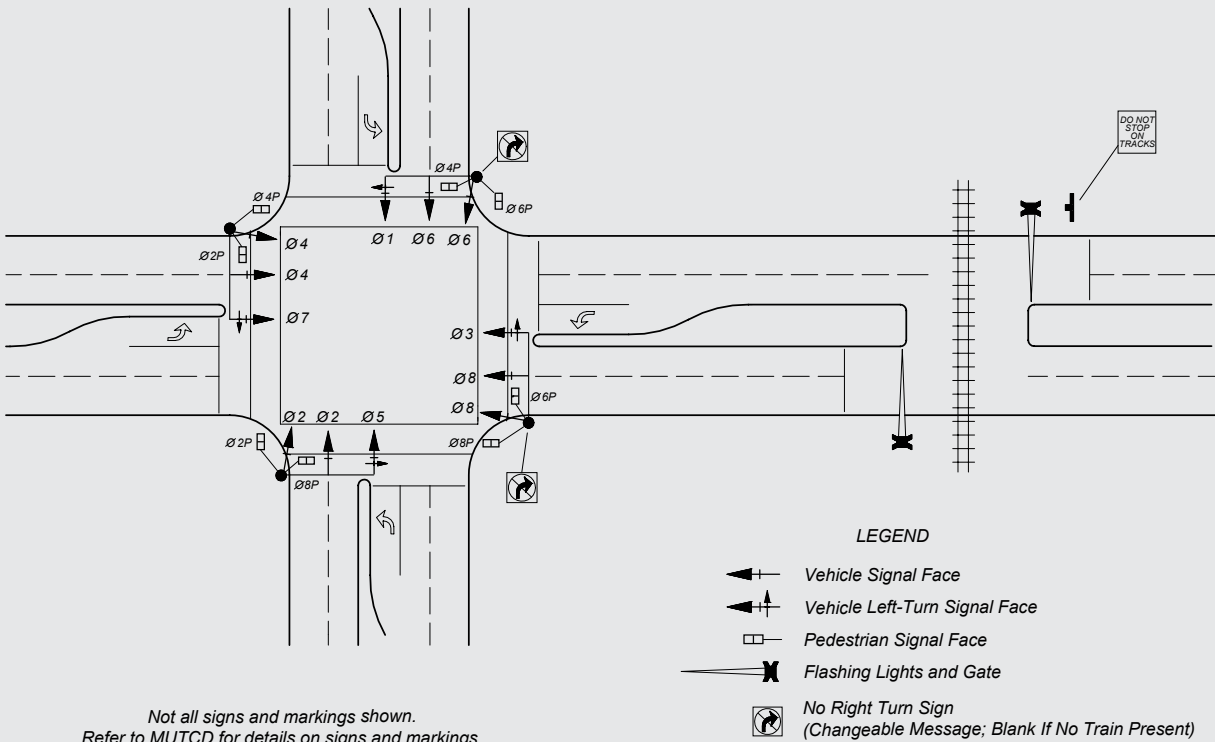

Traffic approaching the tracks from the signalized intersection. The placement of train detection equipment should be governed by the preemption time required to clear the queues. This time should take into account the critical or design vehicle and should be sufficient for this vehicle to clear the intersection safely before the arrival of the train.

A long, slow-moving truck turning toward the tracks could have a problem clearing the intersection if a simultaneous preemption call occurs at the beginning of its turn, especially where the distance between the intersection and the vehicle stop line for the crossing is very short. If the truck makes the turn, encounters a lowering gate, and stops in compliance with the gate, the exit path from the crossing for vehicles approaching the intersection may be blocked even though the traffic signal preemption is functioning and displaying track clearance green. This condition should be studied as part of the system design and, if warranted, advance preemption should be employed to allow adequate time for a truck to clear prior to activating the railroad warning devices.

A long truck or a vehicle required to stop before crossing the tracks in low gear could have a problem clearing a lowering gate as well as clearing the intersection. Both of these scenarios should be considered in the design of the preemption operation if there is a significant volume of trucks. In this case, additional gate delay time may be necessary to allow these vehicles adequate time to restart and clear the crossing prior to lowering of the gates.

Special studies may be needed to determine if traffic approaching the crossing could queue and eventually block the adjacent intersection traffic flow. If determined to be appropriate by an engineering study, blank-out, internally illuminated, or variable message signs reading “No Left Turn” or “No Right Turn” should be used in those situations.⁵ Typical locations of such signs are illustrated in Exhibit 2. Note that if Phase 5 allows permissive left turns, a blank-out “No Left Turn” sign should be used to restrict the left-turn movement during preemption. In addition, traffic signal phases conflicting with the crossing can be omitted from the preemption phasing sequence.

Exhibit 2

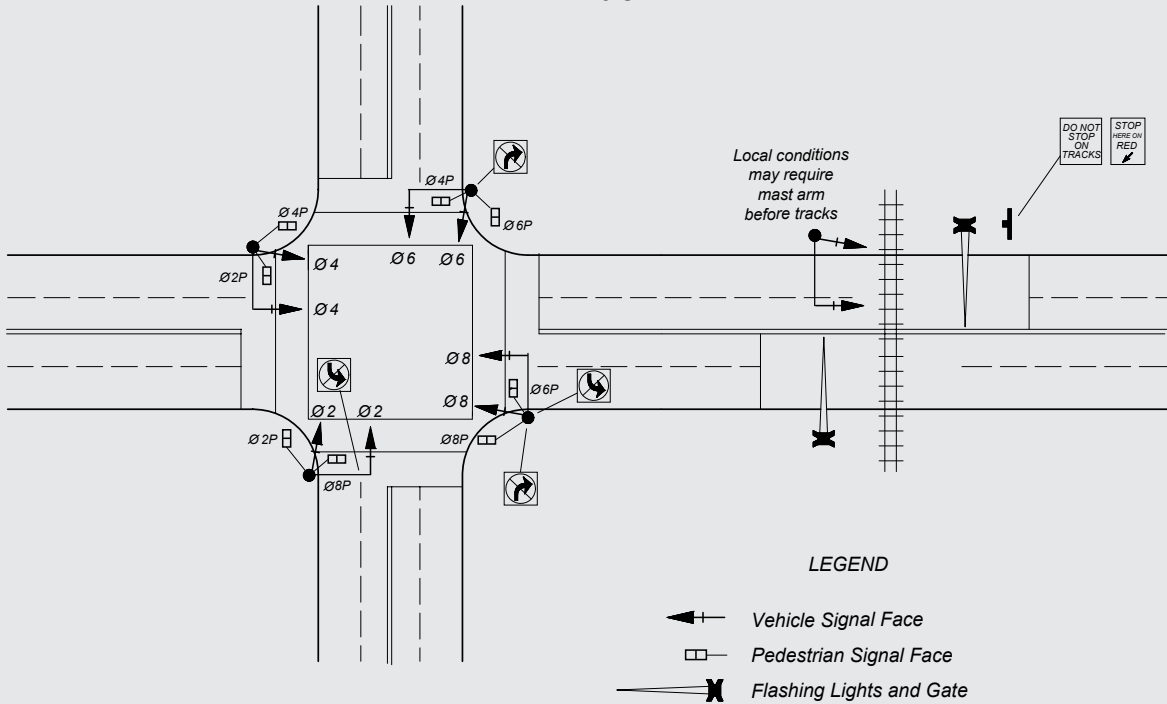

Equations 1 and 2 can also be used to estimate the queue length that is likely to develop for traffic approaching the railroad crossing. The factor q then represents the flow rate (per lane) approaching the crossing, including both traffic passing straight through the signalized intersection toward the crossing as well as traffic that turns left and right off the street that parallels the tracks. The factor r represents the effective time the crossing would be blocked by a train, and can be estimated as:

$$r = 35 + \left(\frac{L}{1.47S} \right)$$

where:

- L = train length (feet)
- S = train speed (mph)

⁵ Bowman, B.L. *Supplemental Advance Warning Devices*. National Cooperative Highway Research Program Synthesis of Highway Practice 198. 1993:48.

The factor of 35 assumes that approximately 25 seconds before the train enters the crossing plus 10 seconds after it clears the crossing, the crossing would still be blocked by the gates. These times may be adjusted as necessary for individual crossings.

Minimum warning time. MUTCD requires a 20-second minimum time for the railroad circuit to activate warning devices prior to arrival of a through train. Neither the basic 20 seconds nor an extended time computed by AREMA criteria (as prescribed by the AREMA *Communications and Signal Manual*, Part 3.3.10), may be sufficient when highway traffic signals are interconnected to a railroad crossing with active warning devices.

The following items should be considered when designing time elements for a preemption operation:

- Approach speed of trains and vehicles on all approaches to the railroad crossing
- Intersection and crossing geometry (including crossing angle, number of tracks, minimum track clearance distance, intersection width, clear storage distance, approach grades, and parallel streets)
- Vehicle volumes
- Frequency of train movement (recognizing complicated, short headway commuter or LRT operations, or switch movements from nearby railroad yards)
- Train stops within the approach to the crossing, especially where stations are located in close proximity to the crossing
- Vehicle queue lengths and dissipation rates, which affect the duration of the clear track green interval⁶
- The design vehicle or special classes of vehicles (buses and large trucks or trucks carrying hazardous cargo). Because some of these vehicles are required to stop and proceed in low gear across the tracks, clearance time for both the tracks and the signalized intersection must be considered.
- Long right-of-way transfer times due to pedestrian intervals, minimum green times, high-speed highway approaches, or unusual intersection geometry
- Types of active warning (flashing light signals alone, flashing light signals with approach-side gates only, or with four-quadrant gates)
- Variability in the warning time provided by constant warning time train detection equipment; train acceleration and deceleration affect warning time; consultation with the railroad is essential for this item.

If one or a combination of the above items requires warning time in excess of the warning time recommended by AREMA criteria, the following techniques may be considered:

- Uniformly extend railroad circuit warning time for both the railroad and the traffic signal controller units, providing simultaneous preemption. This is accomplished by requiring additional clearance time from the railroad for simultaneous preemption. Note, however, that excessive clearance time may result in increased violation of lowered gates by motorists. For this reason, excessive clearance time should be avoided.
- Use advance preemption to start highway traffic signal preemption sequences before railroad warning devices are activated at the railroad crossing.

Systems approach. MUTCD points out the need for a systems approach when designing, installing, and operating highway traffic signals interconnected to railroad crossings. The *Traffic Control Devices Handbook* describes a diagnostic team that may include persons representing highway, railroad, regulatory, and utility agencies as well as manufacturers of highway and railroad equipment. The importance of cooperation and interaction among all responsible parties cannot be emphasized enough. Such cooperation not only encourages the safest design available by combining the latest technology available (or under development) in highway and railroad equipment but also ensures proper operation. Examples include:

- Fully programmable, multiple preemption sequences in highway traffic signal controller units, which allow more than one railroad preemption sequence on a priority basis. They also interact with lesser priority preemption programs from emergency and other special highway vehicles.

⁶ Kinzel, C.D. "Traffic Studies." In *Traffic Engineering Handbook*. Washington, DC: ITE, 1992.

- Railroad constant warning time (CWT) devices, which provide relatively uniform advance warning time between the activation of warning devices and train arrival. CWT is particularly useful where trains travel at significantly different speeds or frequently stop within the control circuit limits (useful in commuter and switching operations).
- Visibility-limited traffic signal faces
- Crossing area vehicle detection systems, using various pavement-based sensing elements such as inductive loops, or non-pavement-based sensing technology such as microwave and video imaging detection equipment
- In-vehicle alert systems for emergency vehicles, school buses, and trucks hauling hazardous material; the systems would advise drivers of approaching trains.
- Supervised interconnect circuits, a circuit configuration that checks the integrity of the interconnect circuit between the railroad control cabinet and the traffic signal controller and minimizes the effect of a false preemption of the traffic signals while the railroad warning devices are not activated. The supervised circuitry can detect if the interconnect circuit is open or wires are crossed and set the traffic signals to flashing operation or send in an alarm.
- Remote monitoring of traffic signal controller assemblies and railroad signal control equipment
- Digital communication between the railroad control system and the traffic signal system; the proposed Institute of Electrical and Electronics Engineers (IEEE) Standard for the Interface Between the Rail Subsystem and the Highway Subsystem at a Highway Rail Intersection (IEEE 1570) defines the logical and physical interfaces and the performance attributes for communication between the two systems. Standardizing the interface will allow interoperability between wide varieties of equipment.
- Stand-by power systems for highway traffic signals⁷
- Train-activated variable message signs
- Pedestrian and bicycle warning devices

Pedestrian clearance phase. MUTCD provides that the pedestrian clearance phase may be “abbreviated” during the railroad preemption of traffic signals. Some agencies have elected to utilize the abbreviated interval; some eliminate the pedestrian clearance phase entirely during the preemption sequencing; others provide full clearance intervals. Abbreviating the pedestrian “Don’t Walk” phase may expedite the intended vehicular cycle; however, it may not expedite pedestrian or driver behavior. Drivers may yield to pedestrians and, thereby, prevent vehicles behind them from clearing off the tracks. To minimize this potential, full pedestrian clearance may be provided but, consequently, additional minimum preemption warning time will be required.

The preemption interconnect may consist of simultaneous preemption (traffic signals are preempted simultaneously with the activation of the railroad control devices), advance preemption (traffic signals are preempted prior to the activation of the railroad control devices), or, possibly, a special design that could consist of two separate closed-loop normally energized circuits. The first, a pedestrian clearance call, should occur at a predetermined length of time to be defined by a traffic engineering study and should continue until the train has departed the crossing. The purpose of the first call is to safely clear the pedestrian. The second, a vehicle clearance call, programmed with a higher priority in the traffic signal controller than the first call, should occur at a predetermined length of time to be determined in a traffic engineering study, but not less than 20 seconds prior to the arrival of a train, and should continue until the train departs the crossing. The purpose of the second call is to clear motor vehicle queues, which may extend into the limits of the crossing.

One preemption interconnect circuit can be used to initially clear out the pedestrian traffic, then a time delay is used for the second vehicular clearance. A system with two separate circuits provides a more uniform timing if the train speed varies once preemption occurred. This is especially important if the train accelerates after the pedestrian clearance is initiated. A timing circuit may not provide adequate warning time.

If the pedestrian clearance phase is abbreviated (or eliminated), additional signing alerting pedestrians of a shortened pedestrian cycle should be considered.

⁷ At the January 2006 meeting of NCUTCD, the council approved a change to indicate back-up power should be provided for traffic signals at locations where preemption or coordination with the railroad warning devices is provided (excepting light-rail transit) for incorporation into the next edition of MUTCD.

Traffic signal controller re-service considerations. Traffic signal controller re-service is the ability of the traffic signal controller to accept and respond to a second demand for preemption immediately after a first demand for preemption has been released, even if the programmed preemption routine/sequence is not complete. In other words, if a traffic signal controller receives an initial preempt activation and shortly thereafter is deactivated, most traffic signal controllers will continue to time out the preemption sequence; if a second demand for preemption is placed during this period, the traffic signal controller must return to the track clearance green. At any point in the preemption sequence, even during the track clear green interval, the controller must return to the start of a full track clearance green interval with a second preemption demand.

Until recently, most traffic signal controllers were unable to recognize a second preempt until the entire preemption sequence of the first activation timed out. If the second demand occurred during the initial preemption sequence, the traffic signal controllers continued the same sequence as if that was still the initial demand for preemption. The traffic signal controller re-service capability must be able to accept and respond to any number of demands for preemption.

The point at which preemption is released from the railroad active control devices to the traffic signals is critical to the proper operation of re-service. For the traffic signal controller to recognize a second demand, the first demand must be released. Therefore, the railroad active control devices must release the preempt activation just as the crossing gates begin to rise, not when they reach a fully vertical position. Otherwise, especially at locations with short storage areas between the crossing and the highway intersection, traffic may creep under the rising gates and, with a second train, a second track clear green interval will not be provided if the gates never reach a fully vertical position.

Programming security. Security of programmed parameters is critical to the proper operation of the highway-rail preemption system. As an absolute minimum, control equipment cabinets should be locked and secure to prevent tampering, and controllers should be password protected. In addition to preventing malicious tampering with control devices, security should be considered to prevent accidental changes in timing parameters, especially in the traffic signal controller, where a programming mistake can easily be made due to the large quantity of parameters, even when just viewing the data.

Some traffic signal controller manufacturers have designed systems in which the critical railroad preemption parameters can not be changed without both proper software and physically making a hardwire change in the traffic signal cabinet. Without proper data changes, the traffic signals will remain in a flashing red operation until the data are corrected. In addition, these systems prevent a different type of controller or controller software from operating the traffic signals. It is important to preserve the integrity of the system once it is tested and proven to operate properly. Another method of preserving the proper timing parameters is remote monitoring of the traffic signal controller. Routine uploads of traffic signal timings can be compared to a database to check for unapproved changes in any timing parameters.

Supervised interconnect circuitry. The interconnection circuit between the highway traffic signal control cabinet and the railroad signal cabinet should be designed as a system. Frequently, the interconnect cable circuit is designed so that the preemption relay can be falsely de-energized, thereby causing a preempt call without the railroad signals being activated. The traffic signals then will cycle through the clearance phase and remain at “stop” until the false preempt call is terminated. If a train approaches the crossing during the false preemption, the railroad signals will activate, but the traffic signals will not provide track clearance phases because they are still receiving the first false call. Even worse, a short between the wires in this type of circuit will virtually disable preemption and will only be recognizable once the railroad active control devices are activated with an approaching train.

Supervised preemption circuits may be used to address this potential problem. In its simplest form, the supervised circuit has two control relays in the traffic control cabinet, each of which is energized by the railroad crossing relay (see Exhibit 3).

One relay, the preemption relay, is energized only when the railroad active control devices are off. The second relay, the supervision relay, is energized only when the railroad active control devices are operating. When

Exhibit 3. Supervised Railroad Interconnect Circuit

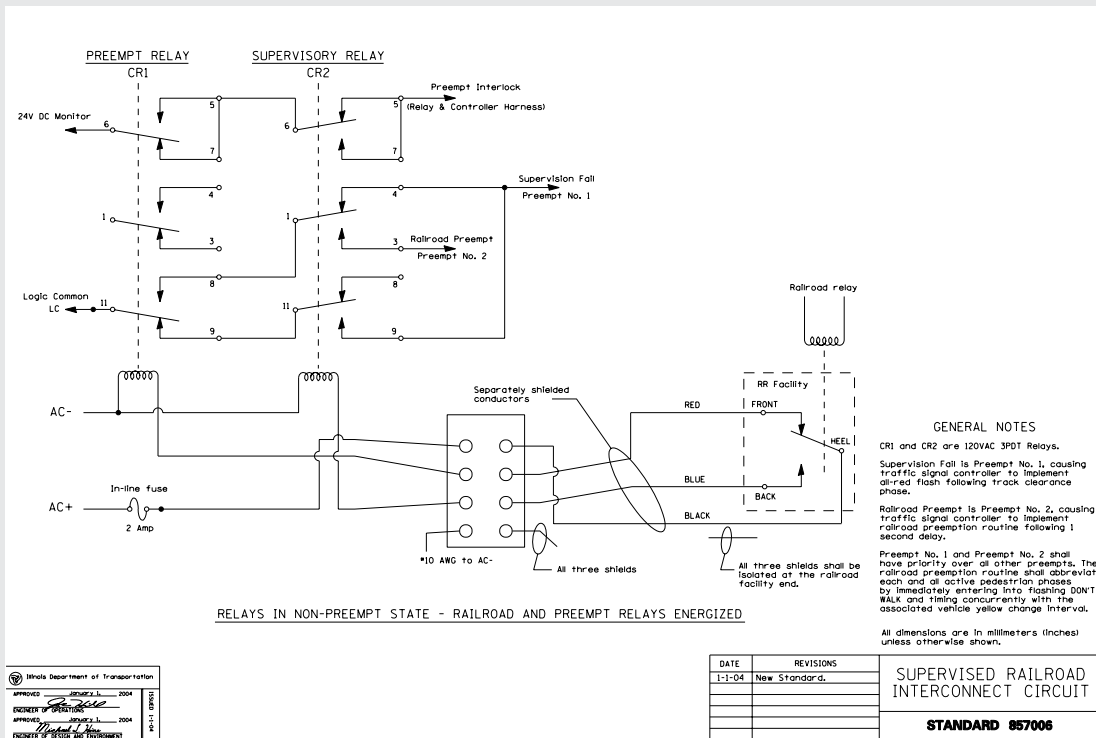

circuited in this manner, only one control relay is energized at a time. If both relays are simultaneously energized or de-energized, the supervision logic determines that there is a problem and can implement action. This action may include initiating a clearance cycle. Upon completion of the clear-out, the traffic signals can go into an all-way flashing red instead of stop. The all-way flashing red will allow traffic to advance off the tracks instead of being held by the red signal. An engineering study may determine that the all-way flashing red is undesirable due to high highway traffic volumes compared to rail traffic.

In all cases, remote monitoring devices that send alarm messages to the railroad and highway authority should be installed. Law enforcement traffic control should be used until repairs can be performed. More information on supervised circuits can be found in “Supervised Interconnection Circuits at Highway-Rail Grade Crossings.”^{8,9}

Other Elements

Use of protected left turns is recommended. A protected left-turn signal indication (a green arrow) should be provided for the intersection approach that crosses the tracks. Depending on the normal signal phase sequence, the left-turn green arrow may or may not be displayed during normal signal operation. However, during the clear track green interval, the left-turn green arrow should be displayed. The intent is to minimize delays to traffic clearing the crossing by providing an indication to left-turning drivers that they have a protected left turn.

8 *Guidance on Traffic Control Devices at Highway-Rail Grade Crossings*. Washington, DC: FHWA, Highway/Rail Grade Crossing Technical Working Group, November 2002.

9 Mansel, D.M., V.H. Waight, and J.T. Sharkey. “Supervised Interconnection Circuits at Highway-Rail Grade Crossings.” *ITE Journal*, Vol. 9, No. 3 (March 1999) (www.ite.org).

Maintain sight lines. Take care to ensure that placement of highway traffic signals does not block the view of railroad flashing light signals. Similarly, railroad crossing equipment should not block the view of highway traffic signals.

Optional use of traffic signals where train movements are slow. Where train movements are very slow, as at industrial crossings or with switching operations, highway traffic control signals can be used in lieu of railroad active warning devices (MUTCD, Section 8D.07). MUTCD stipulates that traffic control signals shall not be used in lieu of flashing light signals at a mainline railroad crossing, and that traffic control signals may be used at LRT crossings under some circumstances. If traffic control signals are used, care must be taken to assure that the system is fail-safe. Back-up power should be supplied for the traffic signals unless there is a signal indication for the train operator, and testing should be conducted to determine that no conditions exist where a green indication can be displayed to road users when a train is approaching or occupying the crossing.

Recommended treatment for crossing between two closely-spaced traffic signals. Where a railroad crossing is located between two closely-spaced signalized intersections, the two highway traffic signals must be interconnected and their preemptions coordinated to permit the track to be cleared in both directions. If the two signals are operated by different public agencies, the agencies should participate in the design and operation of the signals and their preemption or assign responsibility to one agency.

Considerations for second train at multi-track crossings. Where a railroad crossing has more than one through track, special consideration must be given to operation of the warning devices and traffic signal when a second train approaches following the passage of the first train. Provisions may include use of an “extended hold” to maintain the crossing gates down until the second train has arrived, as well as use of traffic signal control logic, which assures that a second track clearance can be provided in the event the gates have been raised prior to the arrival of a second train.

Considerations for closely-spaced multiple railroad crossings. Where multiple tracks or tracks of different railroads cross a highway within preemption distance of the signalized intersection, all the tracks should be considered a single crossing, and the clear track green interval should be of sufficient length to allow a queue across all the tracks to clear. If one or more tracks are widely separated from other tracks closer to the intersection, special track clearance sequencing is necessary, and pre-signals may be considered. When more than one railroad is involved, all the railroads should participate in the design and operation of the preemption. Separate traffic controller unit inputs should be provided for each railroad so that the active track can be distinguished. The AREMA *Communications and Signal Manual*, Part 3.1.11, addresses the design criteria to be addressed by the railroads in the design and operation of the warning devices based on specific distances. Adjacent track clearance time must be determined and implemented in the operation of the warning devices and must also be taken into consideration in designing and operating traffic signal preemption.

Considerations for diagonal crossings. Where the railroad runs diagonally to the direction of the highway, it is probable that the railroad may cross two highway approaches to an interconnected intersection. When this situation occurs, it is normally necessary to clear out traffic on both roadways prior to the arrival of the train, requiring approximately twice the preemption time computed for one approach. It is also normally required to have both railroad active traffic control device systems designed to operate concurrently. This is needed to prevent the interconnected traffic signals and railroad active control devices from falling out of coordination with each other, which otherwise can occur under certain types of train movements or when one of the two crossings experiences a false signal activation prior to an actual train movement.

When the railroad control devices activate, traffic leaving the intersection and approaching either crossing may queue back into the intersection and block traffic if there is not adequate storage for those vehicles between the crossing and the intersection. Traffic turning at the intersection toward the other crossing may also be unable to proceed due to stopped traffic. When this occurs, utilization of advance preemption together with a hybrid design may help alleviate this problem. The hybrid design could consist of delaying the activation of the railroad devices facing vehicles leaving the intersection and approaching both crossings to

help vehicles clear out of the intersection during the preemption sequence.¹⁰

Alternative treatments for long queues. In the event of very long queues, preemption may not be a practical method for clearing the tracks. An alternative treatment may be the use of an automated queue-cutter flashing light beacon upstream of the highway-rail grade crossing. They may be utilized in conjunction with “Do Not Stop on Tracks” (R8-8) signs, as stated in MUTCD. Such beacons can be activated by an induction loop on the departure side of the highway-rail grade crossing that detects a growing queue between the crossing and the distant highway intersection. If the beacons are activated only when the traffic signals on that approach are not green, they can be more effective as opposed to flashing all the time. (Refer also to the discussion of queue cutters and queue management strategies provided in Section 17, Pre-Signals.)

These are some of the many factors that should be considered when interconnecting an active traffic control device at a highway-rail grade crossing to a nearby highway traffic signal. However, it is not the intent of this document to serve as a primer for this very complicated topic. Practitioners should fully familiarize themselves with the ITE recommended practice as well as any more recent guidance and should be sure that expert knowledge and full cooperation between highway and railroad authorities are brought to bear on technical issues regarding the design, construction, operation, and maintenance of interconnected systems.

Appendix I includes forms for computing preemption timing. For additional information, see “Design Guidelines for Railroad Preemption at Signalized Intersections” and “Timing of Traffic Signal Preemption at Intersections Near Highway-Railroad Grade Crossings.”^{11,12}

10 *Guidance on Traffic Control Devices at Highway-Rail Grade Crossings*. Washington, DC: FHWA, Highway/Rail Grade Crossing Technical Working Group, November 2002.

11 Marshall, Peter S. and William D. Berg. “Design Guidelines for Railroad Preemption at Signalized Intersections.” *ITE Journal*, Vol. 67, No. 2 (February 1997).

12 Seyfried, Robert K. “Timing of Traffic Signal Preemption at Intersections Near Highway-Railroad Grade Crossings.” *Compendium of Technical Papers, 2001 Annual Meeting, Institute of Transportation Engineers, August 2001.*

Figure 40. Stand-By Power Arrangement

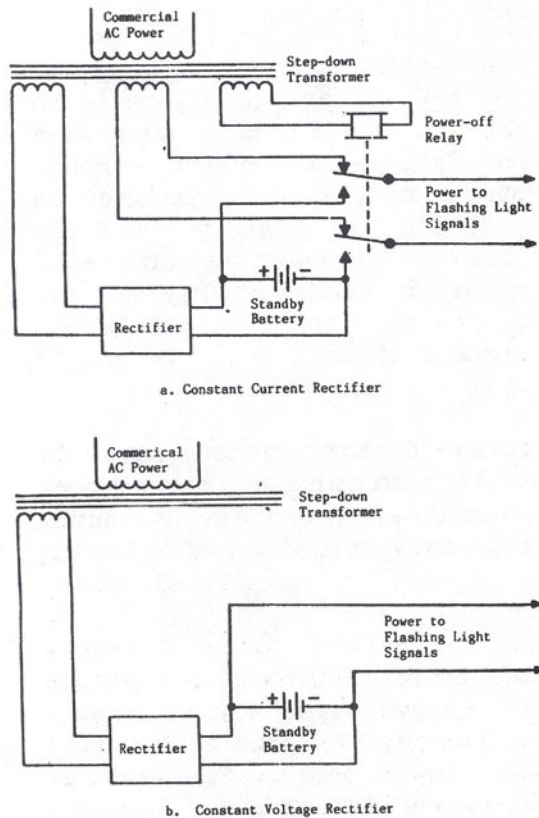

Source: Railroad-Highway Grade Crossing Handbook, Second Edition. Washington, DC: U.S. Department of Transportation, Federal Highway Administration, 1986.

of vehicles using the crossing, highway grades, and the condition of the crossing surface.

Care should be taken to ensure that the warning time is not excessive. If the motorist cannot see the train approaching (due to sight obstructions or track curvature), excessive warning time may cause a motorist to attempt to cross the tracks despite the operation of the flashing light signals.

Excessive warning time has been determined to be a contributing factor in some collisions. Motorists who are stopped at an activated flashing light signal and see no train approaching or see a distant train moving very slowly might ignore the warning of the signals and cross the tracks. A collision could result. For example, the signals may have been activated by a high-speed passenger train just out of sight, not by the slower freight. However, if motorists are successful in clearing the tracks, they may assume that other crossings have excessive warning time. When they encounter

a crossing with minimum warning time, they may ignore the signals, move onto the crossing, and become involved in a collision. This credibility problem is strengthened if motorists continue to successfully pass through activated signals with excessive warning time.

Equipment housing should be located where it is least likely to be struck by a vehicle leaving the roadway. It should not unduly obstruct motorists' view of an approaching train. Factors that may be considered in the design and installation of a train detection system include:

- Existing rail and ballast conditions.
- Volume, speed, and type of highway and rail traffic.
- Other train detection circuits that may be used on the same pair of rails for the regulation of train movements.
- Train propulsion currents on electrified lines.
- Track switch locations within the approach warning distances for a crossing.
- Train detection circuits used for other crossings within the approaches (overlapping).
- Number of tracks.

The design and application of train detection circuits are accomplished by railroad signal engineers. Five basic types of train detection systems are in use today:

- Direct current (DC) track circuit.
- AC-DC track circuit.
- Audio frequency overlay (AFO) track circuit.
- Motion-sensitive track circuit.
- Constant warning time track circuit.

DC track circuit. The DC track circuit, as shown in Figure 41, was the first means used for automatic train detection. It is a relatively simple circuit and is still used in many crossing warning systems. The maximum length of these circuits is more than adequate to provide the necessary warning time for crossing warning systems with today's train speeds.

Figure 41. DC Track Circuit

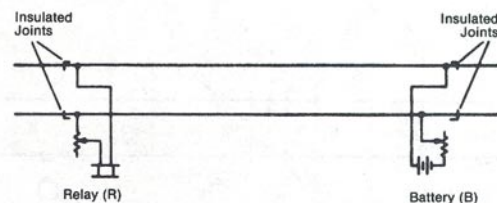

Source: Railroad-Highway Grade Crossing Handbook, Second Edition. Washington, DC: U.S. Department of Transportation, Federal Highway Administration, 1986.

The rails are used as conductors of energy supplied by a battery. This energy flows through a limiting resistor to one rail, then through another limiting resistor to the coil of a DC relay, back over the other rail to the battery, thereby completing a simple series circuit. The relay is energized as long as the rails are intact and no train is present on the circuit between the battery and the relay. The limits of the circuit are established by the use of insulated joints, devices placed between adjoining rail sections to electrically isolate the two sections.

To provide a means for stopping the operation of the crossing warning system as soon as the train clears the crossing, three-track circuits, as shown in Figure 42, and associated logic elements are required per track. The logic elements are arranged such that, as the train moves through the crossing, the crossing clears for highway traffic as soon as the rear end of the train leaves the island section.

Figure 42. Three-Track Circuit System

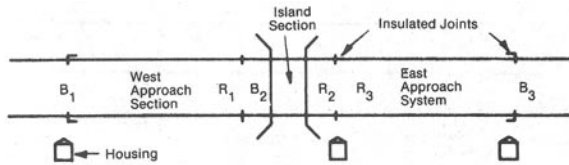

Source: Railroad-Highway Grade Crossing Handbook, Second Edition. Washington, DC: U.S. Department of Transportation, Federal Highway Administration, 1986.

All trains activate the crossing warning system as soon as the first set of wheels of the train enters the approach track circuit. This track circuit must be long enough to provide the minimum warning time for the fastest train. A slow train will operate the crossing warning system for a longer period of time. If a train stops before it reaches the crossing, the crossing warning system continues to operate, which results in an additional delay to highway traffic.

To overcome this problem, approach sections may be divided into several short track circuits, as shown in Figure 43, and timers may be incorporated into the logic. This permits more consistent warning time. Also, if a train stops in the approach section, a “time-out” feature will deactivate the warning devices to allow highway traffic to move over the crossing.

Figure 43. Track Circuits with Timing Sections

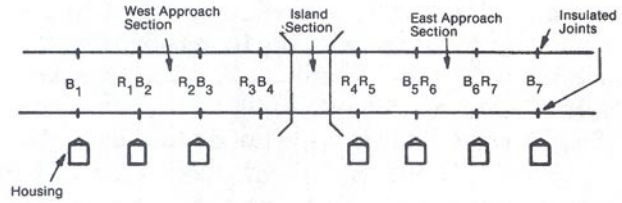

Source: Railroad-Highway Grade Crossing Handbook, Second Edition. Washington, DC: U.S. Department of Transportation, Federal Highway Administration, 1986.

AC-DC track circuit. The AC-DC track circuit, as shown in Figure 44 (sometimes referred to as Type C), is used extensively when approach distances are less than 3,000 feet and no other circuits are present on the rails. The AC-DC track circuit is a half-wave rectified AC circuit with all operating equipment located at the crossing. A rectifier is connected across the rails at the far end of the track circuit. As is the case with DC circuits, insulated joints define the limits. An advantage of this circuit is that all control equipment is located in a single housing at the crossing. Shunting is also improved due to the somewhat higher voltages used across the rails.

Figure 44. AC-DC Track Circuit

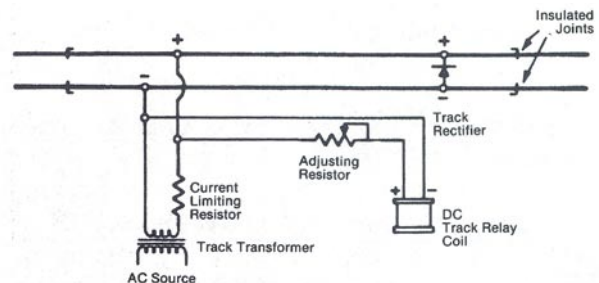

Source: Railroad-Highway Grade Crossing Handbook, Second Edition. Washington, DC: U.S. Department of Transportation, Federal Highway Administration, 1986.

A simple explanation of the operation of the AC-DC (or Type C) track circuit is that the major portion of the transformer secondary current flows through the rectifier during one half-cycle and through the relay during the other half-cycle, providing a net DC component in the track relay. A shunt on the rails reduces the rail voltage, causing the track relay to release, thereby activating the system. As is the case with DC track circuits, three circuits are normally used to establish train direction.

AFO track circuit. The AFO track circuit, as shown in Figure 45, is similar in application to the DC track circuit, except that it can be superimposed over other

Figure 45. Audio Frequency Overlay Track Circuit

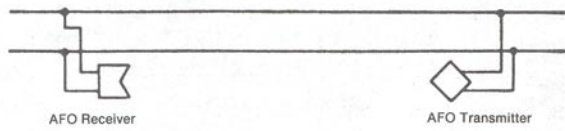

Source: Railroad-Highway Grade Crossing Handbook, Second Edition. Washington, DC: U.S. Department of Transportation, Federal Highway Administration, 1986.

circuits that may exist on the rails. Instead of the battery and relay used in the DC circuit, a transmitter and receiver of the same frequency are used for each AFO track circuit. No insulated joints are required with this type of circuit.

The AFO track circuit uses an AC signal applied to the rails through a transmitter. This signal is transmitted via the rails to a receiver at the opposite end of the track circuit, which converts the AC signal to DC to operate a relay, which, in turn, performs the function of operating the warning devices via the control logic similar to the DC track circuit. Once again, three circuits are required to establish the direction in which the train is moving.

Motion-sensitive track circuit. This type of circuit employs audio frequencies similar to AFO equipment and is designed to detect the presence as well as the direction of motion of a train by continuously monitoring the track circuit impedance. As long as the track circuit is unoccupied or no train is moving within the approach, the impedance of the track circuit is relatively constant. Decreasing track circuit impedance indicates that a train is moving toward the crossing. If a train subsequently stops, the impedance will again remain at a constant value. If the train is moving away from a crossing, the impedance will increase. Thus, if the train stops on the approach or moves away from the crossing, the crossing warning system is deactivated and the crossing is cleared for highway traffic.

This type of circuit is advantageous where trains stop or conduct switching operations within the normal approach limits of a particular crossing. All powered equipment is located at the crossing, with the additional advantage that insulated joints are not required when applied in a bi-directional manner, as shown in Figure 46. Adjacent crossing circuits can be overlaid and overlapped with other train detection circuits. Tuned electrical shunts are required to define the end limits of motion sensitive circuits, and coupling units are required to bridge any existing

Figure 46. Motion-Sensitive Track Circuit, Bi-Directional Application

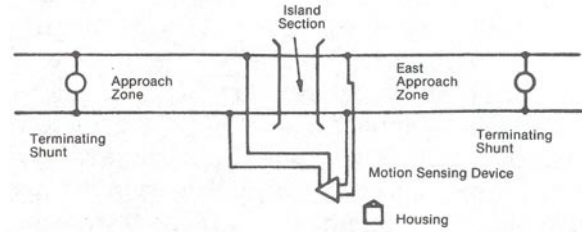

Source: Railroad-Highway Grade Crossing Handbook, Second Edition. Washington, DC: U.S. Department of Transportation, Federal Highway Administration, 1986.

insulated joints used in conjunction with other types of track circuits, such as might be required for wayside signaling purposes.

Where longer approach zones are required or where ballast or track conditions dictate, a uni-directional application may be desirable. In this type of application, one device is required for each approach zone, with insulated rail joints used to separate the two approach zones, as shown in Figure 47.

Figure 47. Motion-Sensitive Track Circuit, Uni-Directional Application

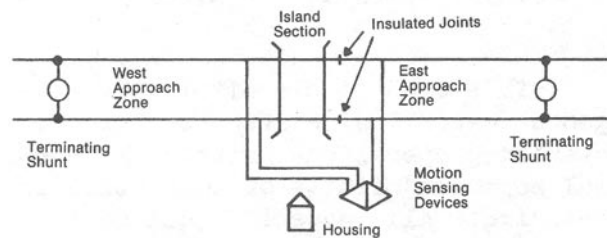

Source: Railroad-Highway Grade Crossing Handbook, Second Edition. Washington, DC: U.S. Department of Transportation, Federal Highway Administration, 1986.

Constant warning time track circuit. Constant warning time equipment has the capability to sense a train in the approach section, measure its speed and distance from the crossing, and activate the warning equipment to provide the selected minimum warning time. Thus, regardless of train speed, a uniform warning time is provided. If a train stops prior to reaching the crossing or is moving away from the crossing, the warning devices are deactivated to allow highway traffic to move over the crossing. With constant warning time equipment, trains beyond 700 feet (213 meters) can

move or switch on the approaches without reaching the crossing and, depending on their speed, never cause the crossing warning devices to be activated, thus eliminating unnecessary delays to highway traffic.

The latest constant warning time devices, like motion-sensitive devices, may be applied either in a uni-directional or bi-directional mode, as shown in Figures 48 and 49, respectively. A uni-directional application requires two devices, one monitoring each approach zone, with the approach zones separated by insulated rail joints. A terminating shunt is placed at the outermost end of each approach zone. The location of the terminating shunt is determined by the fastest train using the crossing.

Figure 48. Constant Warning Time Track Circuit, Uni-Directional Application

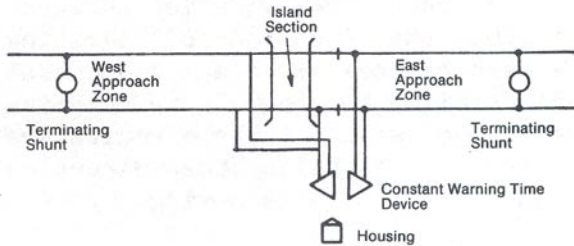

Source: Railroad-Highway Grade Crossing Handbook, Second Edition. Washington, DC: U.S. Department of Transportation, Federal Highway Administration, 1986.

Figure 49. Constant Warning Time Track Circuit, Bi-Directional Application

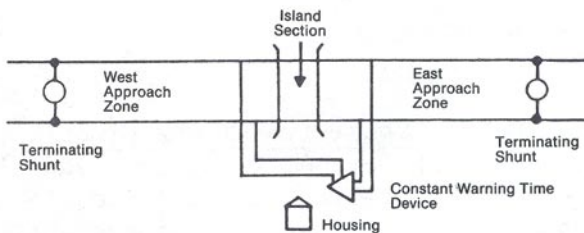

Source: Railroad-Highway Grade Crossing Handbook, Second Edition. Washington, DC: U.S. Department of Transportation, Federal Highway Administration, 1986.

A uni-directional application is suggested in situations where there are closely following train moves or to break up frequency pollution. Uni-directional installations are suggested to avoid bypassing insulated joint locations when bypassing these joints is not desirable.

A bi-directional application uses a single constant warning time device, which monitors both approach

zones. Insulated rail joints are not required. Again, terminating shunts are placed at the outermost end of each approach zone. The bi-directional application is normally used where moderate train speeds are employed, thus requiring shorter approach zones, and where track and ballast conditions permit.

Motion-sensing and constant warning time track circuits should be considered for crossings on railroad mainlines, particularly at crossings with variations in train speeds and with a number of switching movements on the approach sections.

Warning time and system credibility.

Reasonable and consistent warning times reinforce system credibility. Unreasonable or inconsistent warning times may encourage undesirable driver behavior. Research has shown that when warning times exceed 40–50 seconds, drivers will accept shorter clearance times at flashing lights, and a significant number will attempt to drive around gates. Although mandated maximum warning times do not yet exist, efforts should be made to ensure that traffic interruptions are reasonable and consistent without compromising the intended safety function of an active control device system’s design.

Excessive warning times are generally associated with a permanent reduction in the class of track and/or train speeds without a concomitant change in the track circuitry or without constant warning time equipment. When not using constant warning train detection systems, track approach circuits should be adjusted accordingly when train speeds are permanently reduced. Another frequent cause of excessive warning times at crossings without constant warning time equipment is variable-speed trains, such as intercity passenger trains or fast commuter trains interspersed with slower freight trains.

A major factor affecting system credibility is an unusual number of false activations at active crossings. Every effort should be made to minimize false activations through improvements in track circuitry, train detection equipment, and maintenance practices. A timely response to a system malfunction coupled with repairs made without undue delay can reduce credibility issues. Remote monitoring devices are an important tool.

Joint study and evaluation are needed between the highway agency and the railroad to make a proper selection of the appropriate train detection system.

Train detection systems are designed to provide the minimum warning time for a crossing. In general,

MUTCD requires that the system provide for a minimum of 20 seconds of warning time. When determining if the minimum 20 seconds of warning time should be increased, the following factors should be considered:

- Track clearance distances due to multiple tracks and/or angled crossings (add 1 second for each 3 meters (10 feet) of added crossing length in excess of 10.7 meters (35 feet)).
- The crossing is located within close proximity of a highway intersection controlled by STOP signs where vehicles have a tendency of stopping on the crossing.
- The crossing is regularly used by long tractor-trailer vehicles.
- The crossing is regularly used by vehicles required to make mandatory stops before proceeding over the crossing (such as school buses and hazardous materials vehicles).
- The crossing's active traffic control devices are interconnected with other highway traffic signal systems.
- Provide at least 5 seconds between the time the approach lane gates to the crossing are fully lowered and when the train reaches the crossing, per 49 CFR Part 234.
- The crossing is regularly used by pedestrians and non-motorized components.
- Where the crossing and approaches are not level.
- Where additional warning time is needed to accommodate a four-quadrant gate system.

It should be noted that even when constant warning devices are used, the calculated arrival time of the train at the crossing is based on the instantaneous speed of the train as it enters the crossing circuit. Once the calculation is made, changes in train speed will change train arrival time at the crossing and, correspondingly, reduce (or increase) the elapsed warning time at the crossing. This factor must be considered at a crossing interconnected to a nearby highway traffic signal utilizing either a simultaneous or advance preemption sequence.

Design information about railroad interconnection circuits and approach length calculations can be found in the AREMA *Communications and Signal Manual*, Part 3.1.10, "Recommended Functional/Operating Guidelines for Interconnection Between Highway Traffic Signals and Highway-Rail Grade Crossing Warning Systems," and Part 3.3.10, "Recommended Instructions for Determining Warning Time and Calculating Minimum Approach Distance for Highway-Rail Grade Crossing Warning Systems."⁹⁸

98 American Railway Engineering and Maintenance-of-Way Association. *Communications and Signal Manual*, Part 3.1.10 (www.arema.org/pubs/pubs.htm).

17. Pre-Signals

A recent article in *ITE Journal* describes and summarizes the state of the practice regarding the use of pre-signals—highway signals installed to stop traffic before it crosses the railroad.⁹⁹ The purpose of installing highway traffic signals in this manner at a crossing is to prevent vehicles from queuing across the grade crossing and finding themselves stopped on the tracks in the area now known as the minimum track clearance distance.

Differing names or descriptions were given to early pre-signal installations, such as double clearance signals, signals before the tracks, and overlap signals, among others. Previously, there were no broadly accepted guidelines for the use of these specialized signals. In June 1997, a U.S. DOT task force established industry-standard definitions relating to the interconnection of highway traffic signals with highway-rail grade crossing warning systems. In this report, pre-signals were defined as: "supplemental highway traffic signal faces [that are] operated as a part of the highway intersection traffic signals, [and are] located in a position that controls [highway] traffic approaching the railroad crossing and intersection."¹⁰⁰

The timing and display of these highway traffic signals are integrated with the railroad's preemption program. FHWA's "Guidance on Traffic Control Devices at Highway-Rail Grade Crossings" illustrates a typical installation of pre-signals at a gated crossing. The illustration depicts the elements common to the pre-signal installations normally encountered.¹⁰¹

MUTCD Section 8D.07 lays out a framework of standards, guidance, and options for the use of pre-signals:

If used, the pre-signals shall display a red signal indication during the track clearance portion of a signal preemption sequence to prohibit additional vehicles from crossing the railroad track... If a pre-signal is installed at an interconnected highway-rail grade crossing near a signalized intersection, a STOP HERE ON RED (R10-6) sign shall be installed near the pre-signal or at the stop line if used. If there is a nearby signalized intersection with insufficient

99 Gilleran, Brian F. "Use of Pre-Signals in Advance of a Highway-Rail Grade Crossing: A Specialized Tool with Specific Applications." *ITE Journal*, Vol. 76, No. 5 (May 2006): 22–25.

100 *Implementation Report of the U.S. DOT Grade Crossing Safety Task Force, Report to Secretary Rodney E. Slater*. FHWA-SA-97-085, Grade Crossing Safety Task Force, 1997.

101 *Guidance on Traffic Control Devices at Highway-Rail Grade Crossings*. Washington, DC: FHWA, Highway/Rail Grade Crossing Technical Working Group, November 2002.

clear storage distance for a design vehicle, or the highway-rail grade crossing does not have gates, a NO TURN ON RED (R10-11) sign shall be installed for the approach that crosses the railroad track.

The option is offered in MUTCD Section 8D.07 to time the pre-signals with an offset from the signalized intersection (by providing a “green extension” at the downstream intersection signal); this would keep vehicles from occupying either the roadway area between the gates or the area between the grade crossing and the downstream signalized intersection. This option should be explored during a field review by the diagnostic team prior to the design and installation of the pre-signals.

Criteria for use. In 2004, ITE issued a recommended practice that provides the following guidance:¹⁰²

Pre-signals can be located to stop vehicular traffic before the railroad crossing where the clear storage distance (measured between 6 ft. (2 m) from the rail nearest the intersection to the intersection stop line or the normal stopping point on the highway) is 50 ft. (15 m) or less. At approaches where high percentages of multi-unit vehicles are evident, the distance should be increased to 75 ft. (23 m). A vehicle classification study should be conducted to determine the types of vehicles using the crossing. Where the clear storage distance is greater than 50 ft. (15 m) or 75 ft. (23 m), depending on the roadway vehicle design length, but less than 120 ft. (37 m), pre-signals can be used only after an engineering study determines that the queue extends into the track area.

If the clear storage distance is greater than 120 ft. (37 m), any traffic signal heads located at a railroad crossing should be considered to be a separate mid-block crossing (a “queue-cutter” signal), and not a pre-signal. However, coordination with the intersection signals may still be appropriate. Pre-signals or queue-cutter signals should also be used wherever traffic could queue across the tracks and railroad warning devices consist only of flashing light signals. However, this can result in conflicting signal indications between the

flashing red lights at the crossing and a display of track clearance green beyond the crossing. The installation of gates will eliminate this conflict.

Pre-signal location. Pre-signal mast arm poles can be located upstream or downstream from the railroad crossing. In all cases, pre-signal poles must be located to maintain visibility of the railroad flashing lights. If an existing railroad cantilever exists, and upstream pre-signals are used, the heads may be mounted on the cantilever if permitted by the railroad or regulatory agency. If they are on a separate mount, they must be located to avoid blockage or interference with the visibility of the railroad flashing lights. Railroad flashing lights should be located as specified in Chapter 8D of MUTCD. Refer also to AREMA *Communications and Signal Manual* Parts 3.1.36 and 3.1.37 for additional guidance regarding the location of railroad warning devices.¹⁰³ Figure 50 shows a pre-signal mounted on the railroad cantilever.

MUTCD Section 4D.15 (“Size, Number, and Location of Signal Faces by Approach”) establishes the standards for traffic signal faces that shall be satisfied by any installation of pre-signals. Specifically, Section 4D.15 states as a standard that signal faces for the major movement on the approach shall be located not less than 12 meters (40 feet) beyond the stop line. MUTCD Table 4D-1 contains the required minimum sight distance for a range of 85th-percentile approach speeds. If these minimums cannot be met on an approach, a sign shall be installed to warn approaching traffic of the traffic control signal. In Figure 51, the pre-signal stop bar has been displaced ahead of the grade crossing to comply with this provision where the pre-signal is mounted ahead of the grade crossing.

Downstream signal.

The downstream traffic signal faces at the roadway intersection that control the same approach as the pre-signal may be equipped with programmable-visibility heads or louvers as appropriate based on an engineering study. The purpose of the signal programmable-visibility heads or louvers is to limit visibility of the downstream signal faces to the area from the intersection stop line to the location of the first vehicle behind the pre-signal stop line. This is to prevent vehicles stopped at the railroad crossing stop line from seeing the distant green signal indication during the clear track green. An engineering study

¹⁰² *Preemption of Traffic Signals Near Railroad Crossings: An ITE Recommended Practice.* Prepared by Traffic Engineering Council Committee TENC-99-06. Washington, DC: Institute of Transportation Engineers, July 2003.

¹⁰³ *Ibid.*

Figure 50. Pre-Signal Mounted on Railroad Cantilever, Rollins Road and State Route 83 at Wisconsin Central, Round Lake, Illinois



Source: Korve Engineering, Inc.

Figure 51. Pre-Signal Located Ahead of Grade Crossing with Displaced Stop Bar, S. Mary and W. Evelyn at Caltrain Commuter Line, Sunnyvale, California



Source: Korve Engineering, Inc.

Figure 52. Pre-Signal with Louvered Downstream Intersection Signal, Sierra and Orange at Metrolink Commuter Line, Fontana, California



Source: Korve Engineering, Inc.

should be conducted to review the specific site conditions, including the eye heights of drivers of vehicles likely to use the crossing, and establish the final design necessary to meet the visibility requirements.¹⁰⁴

Figure 52 shows a pre-signal with a louvered downstream intersection signal. The pre-signal has been installed beyond the grade crossing to address the previously mentioned MUTCD 40-foot set-back requirement for traffic signal heads.

Pre-signal and downstream signal operation.

The pre-signal intervals should be progressively timed with the downstream signal intervals to provide adequate time to clear vehicles from the track area and the downstream intersection. Vehicles that are required to make a mandatory stop such as

school buses, vehicles hauling hazardous materials, etc., should be considered when determining the progressive timing to ensure that they will not be stopped within the minimum track clearance distance. Where the clear storage distance is inadequate to store a design vehicle clear of the minimum track clearance distance and crossing gates are present, consideration should be given to installation of vehicle detection within the clear storage distance to prevent vehicles from being trapped within the minimum track clearance distance by extending the clear track green interval.¹⁰⁵

Queue cutters. It is valuable to remember that although a queue cutter signal may in many ways resemble a pre-signal, it differs in certain ways. A signal should be used as a queue cutter when the

104 Ibid.

105 Ibid.

Figure 53. Queue Cutter, Magnolia Street at Union Pacific Railroad, Riverside, California



Source: Korve Engineering, Inc.

clear storage distance exceeds 120 feet and the traffic signal uses downstream vehicle detection to change the signals to red when the standing queue from the downstream signal is about to extend into the minimum track clearance distance. Such a queue cutter signal will be interconnected for simultaneous preemption and may or may not function as a part of the downstream intersection signal system. A field analysis and review should be conducted, sufficient to determine whether to pursue coordination of the queue cutter with the downstream intersection signals. Figure 53 indicates a stand-alone queue cutter (no other intersection signals are present).

Advance heads. Advance heads are traffic signal heads that provide the same display indication upstream from the grade crossing as the primary traffic signal heads mounted at the downstream intersection (see Figure 54). A vehicle that encounters a yellow indication at the advance head may not be able to clear the downstream intersection and, therefore, may stop in the clear storage area between the intersection and the grade crossing. For this reason, advance heads are best used when there is little or no clear storage distance beyond the grade crossing. However, vehicles

arriving after the onset of the red phase will be held upstream from the grade crossing. Therefore, use of an advance head can reduce the likelihood of queuing on the tracks during the red phase. Advance heads can also address issues in which the intersection heads are not readily visible to drivers approaching the grade crossing due to roadway geometrics.

Overcoming resistance to pre-signals. Some traffic engineers may be reluctant to use pre-signals because they believe that vehicles stopped upstream from the crossing at the pre-signal will be prevented from being able to advance to the highway intersection and turn right on red. The temporary loss of flow due to right turn on red being precluded during the presence of a train is outweighed by the reduction in the potential for a severe collision between a stopped vehicle and a train. Unfortunately, the opportunity for this type of collision is frequent when viewed on a national basis. In addition, the capacity lost from right turns on red often can be recaptured by more precise timing of the traffic signal preemption sequence based upon site conditions, especially when the railroad crossing is frequently used by train traffic.

Figure 54. Advance Head, Broadway and Arguello at Caltrain Commuter Line, Redwood City, California



Source: Korve Engineering, Inc.

Avoiding common pitfalls of pre-signals. As stated in an *ITE Journal* article, pre-signals are a specialized tool with specific applications.¹⁰⁶ Traffic engineers should bear in mind several important principles when considering the use of a pre-signal system at a highway-rail grade crossing:

- A pre-signal is not a substitute for a proper track clearance green interval.
- Employing pre-signals requires that engineers consider the use of “No Turn on Red” signage at the pre-signal to deter drivers wishing to turn right on red at the downstream intersection from passing the pre-signals and crossing the tracks.
- A pre-signal face located less than 40 feet from the stop line will not be effective for motorists at the stop line. In the case of a shorter separation distance between pre-signal and stop line, motorists may be tempted to pull out onto the track when the track clearance green interval is displayed.
- A pre-signal is not an alternative to the use of advance preemption. Advance preemption

is necessary where the right-of-way transfer time, queue clearance time, and separation time exceed the railroad warning time, and the clear storage distance exceeds approximately 80 feet (adequate storage distance for a 65-foot tractor-trailer combination). Advance preemption also may be required where this distance is less than 80 feet to prevent vehicle-gate interaction (striking the vehicle with the descending gate arm) or to prevent turning vehicles approaching the crossing from the intersection side from blocking the exit path of vehicles attempting to vacate the crossing during track clearance green.

- If a pre-signal is expected to keep vehicles off the tracks and function as a part of the preemption sequence, it must be provided with battery back-up equivalent to that provided for the railroad warning devices.

18. Queue Prevention Strategies

In the event that queuing extends across multiple intersections, use of preemption, pre-signals, and/or queue cutters may be ineffective, and a broader treatment may be required. The following guidance was adapted

¹⁰⁶ Gilleran, Brian F. “Use of Pre-Signals in Advance of a Highway-Rail Grade Crossing: A Specialized Tool with Specific Applications.” *ITE Journal*, Vol. 76, No. 5 (May 2006): 22–25.

Figure 55. Queue Prevention Strategies

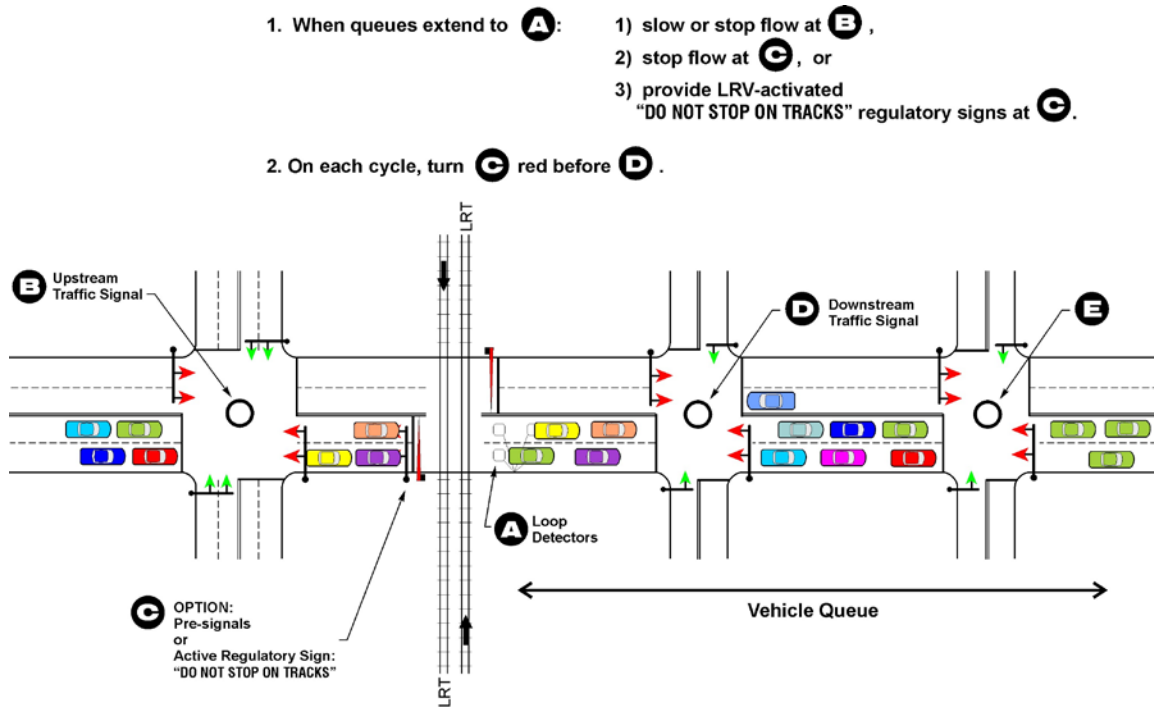

Source: Korve Engineering, Inc.

from material presented in the context of managing cross-street queuing at LRT grade crossings.¹⁰⁷

At highway-rail grade crossings located near signalized intersections, where traffic congestion precludes using standard traffic signal preemption, traffic control strategies may be used to prevent queues from extending back over the tracks (see Figure 55). Standard traffic signal preemption operates under the assumption that motor vehicles queue back from the nearby signalized intersection (signal D in Figure 55). The preemption sequence (occurring at the traffic signals downstream of the grade crossing) then clears these queued vehicles off the tracks before the train arrives at the crossing.

However, at some locations, it may not be practical or possible to clear vehicles from the tracks by preempting the downstream traffic signals. For example, if the roadway corridor extending downstream from the grade crossing is heavily congested, preempting the downstream traffic signals still may not allow motor vehicles to move forward enough to clear the crossing because of downstream congestion. If the level of

traffic congestion is substantial, it may be necessary to preempt several downstream traffic signals, which requires an approaching train to be detected (and predicted) several minutes before it arrives at the crossing. In such cases, a queue prevention strategy may be more appropriate.

The basic concept of queue prevention is as follows: If a queue is detected across a highway-rail grade crossing, traffic approaching the crossing will be stopped by a signal upstream of the grade crossing (signals B or C in Figure 55) to prevent the queue from building back across the tracks. As indicated, vehicle detectors can be installed at location A; if stopped or slow vehicles are detected at location A, logic built into the traffic signal system could:

- Stop the major flow of traffic at signal B (including control of turning traffic if necessary and appropriate).
- Stop the flow of traffic at signal C by using traffic signals on the near side of the LRT crossing (such as pre-signals, as previously described).
- Warn highway users not to stop on the tracks by providing an activated, internally illuminated "Do Not Stop on Tracks" sign (R8-8) mounted on a mast arm over each lane of

107 Korve, Hans W., Brent D. Ogden, Joaquin T. Siques, D. Mansel, et al. *Light Rail Service: Pedestrian and Vehicular Safety*. Washington, DC: Transit Cooperative Research Program Report 69, National Academy Press, 2001, p. 85–86.

traffic at location C (these signs would activate when queues are detected at location A).

- Provide exclusion zone diagonal striping as described elsewhere in this handbook. (The use of diagonal striping to provide an area where motorists cannot stop is standard practice in Illinois at all grade crossings that are interconnected to an adjacent traffic signal. The NCUTCD grade crossing committee is considering provisions for future versions of the manual).

In the event that such a queue management strategy were provided, the grade crossing would in principle be clear of highway users at all times, whether or not a train was approaching the crossing, and the use of preemption would operate more as a fail-safe measure rather than a primary measure for keeping the tracks clear.

J. Pedestrian and Bicycle Considerations

Non-motorist crossing safety should be considered at all highway-rail grade crossings, particularly at or near commuter stations and at non-motorist facilities, such as bicycle/walking trails, pedestrian-only facilities, and pedestrian malls.

Passive and active devices may be used to supplement highway-related active control devices to improve non-motorist safety at highway-rail crossings. Passive devices include fencing; swing gates; pedestrian barriers; pavement markings and texturing; refuge areas; and fixed message signs. Active devices include flashers; audible active control devices; automated pedestrian gates; pedestrian signals; variable message signs; and blank-out signs.

These devices should be considered at crossings with high pedestrian traffic volumes; high train speeds or frequency; extremely wide crossings; complex highway-rail grade crossing geometry with complex right-of-way assignment; school zones; inadequate sight distance; and/or multiple tracks. All pedestrian facilities should be designed to minimize pedestrian crossing time, and devices should be designed to avoid trapping pedestrians between sets of tracks.

Guidelines for the use of active and passive devices for non-motorist signals and crossings are found in MUTCD Section 10D, Part 10.¹⁰⁸

¹⁰⁸ *Guidance on Traffic Control Devices at Highway-Rail Grade Crossings*. Washington, DC: FHWA, Highway/Rail Grade Crossing Technical Working Group, November 2002.

K. Roundabouts

In the event that a grade crossing is included in a roundabout, design considerations include the provision of traffic control (such as crossing gates and flashing lights) at the grade crossing consistent with treatments at other highway-rail grade crossings. In addition, where queuing could occur (such as gridlocking within the roundabout), additional measures may be necessary up to and including the installation of supplementary devices such as traffic signals to preclude blockages of the track that cannot be cleared in advance of the arrival of a train.

At the June 2006 meeting of NCUTCD, the council approved provisions that would require an engineering study of the potential for traffic to back up across a grade crossing due to a roundabout and the identification of appropriate countermeasures, including possible use of traffic signals.

L. Site and Operational Improvements

In addition to the installation of traffic control systems, site and operational improvements can contribute greatly to the safety of highway-rail grade crossings. Site improvements are discussed in four categories: removing obstructions, crossing geometry, illumination, and safety barriers.

1. Removing Obstructions

The following text identifies treatments to address various sight distance needs, previously discussed in Chapter III as part of the diagnostic study method.

Approach. To permit this, three areas of the crossing environment should be kept free from obstructions. The area on the approach from the driver ahead to the crossing should be evaluated to determine whether it is feasible to remove any obstructions that prevent the motorist from viewing the crossing ahead, a train occupying the crossing, or active control devices at the crossing.

Clutter is often a problem in this area, consisting of numerous and various traffic control devices, roadside commercial signing, utility and lighting poles, and vegetation. Horizontal and vertical alignment can also serve to obstruct motorists' view of the crossing. Clutter can often be removed with minimal expense, improving the visibility of the crossing and associated

traffic control devices. Traffic control devices unnecessary for the safe movement of vehicles through the crossing area should be removed. Vegetation should be removed or cut back periodically. Billboards should be prohibited on the approaches.

Corner. View obstructions often exist within the sight triangle, typically caused by structures; topography; crops or other vegetation (continually or seasonal); movable objects; or weather (fog or snow). Where lesser sight distances exist, motorists should reduce speed and be prepared to stop not less than 4.5 meters (15 feet) before the near rail, unless and until they are able to determine, based upon the available sight distance, that there is no train approaching and it is safe to proceed. Wherever possible, sight line deficiencies should be improved by removing structures or vegetation within the affected area, regrading an embankment, or realigning the highway approach.

Many conditions, however, cannot be corrected because the obstruction is on private property or it is economically infeasible to correct the sight line deficiency. If available corner sight distance is less than what is required for the legal speed limit on the highway approach, supplemental traffic control devices such as enhanced advance warning signs, STOP or YIELD signs, or reduced speed limits (advisory or regulatory) should be evaluated. If it is desirable from traffic mobility criteria to allow vehicles to travel at the legal speed limit on the highway approach, active control devices should be considered.¹⁰⁹

Changes to horizontal and vertical alignment are usually more expensive. However, when constructing new highways or reconstructing existing highways, care should be taken to minimize the effects of horizontal and vertical curves at a crossing.

The approach sight triangle is the second area that should be kept free from obstructions. This area provides an approaching motorist with a view of an approaching train. It can encompass a large area that is usually privately owned. In rural areas, this sight triangle may contain crops or farm equipment that block the motorist's view. For this reason, clearing the sight triangle may be difficult to achieve. However, obstructions should be removed, if possible, to allow vehicles to travel at the legal speed limit for the approach highway. Vegetation can be removed or cut back periodically, billboards and parking should be prohibited, and small hills may be regraded.

Clearing sight distance. The third area of concern is the clearing sight distance, which pertains to the visibility available to a highway user along the track when stopped ahead of the grade crossing. Usually, this area is located on railroad right of way. Vegetation is often desired along railroad right of way to serve as an environmental barrier to noise generated from train movements. However, the safety concern at crossings is of more importance and, if possible, vegetation should be removed or cut back periodically. Also, if practical, this sight distance area should be kept free of parked vehicles and standing railroad cars. Care should be taken to avoid the accumulation of snow in this area.

Vehicle acceleration data have been interpreted from the *Traffic Engineering Handbook*. The person or agency evaluating the crossing should determine the specific design vehicle, pedestrian, bicyclist, or other non-motorized conveyance and compute clearing sight distance, if it is not represented in Table 41. Note that the table values are for a level, 90-degree crossing of a single track. If other circumstances are encountered, the values must be recomputed.

If there is insufficient clearing sight distance, and the driver is unable to make a safe determination to proceed, the clearing sight distance needs to be improved to safe conditions or flashing light signals with gates, closure, or grade separation should be considered. (Refer to the guidance developed by the U.S. DOT Technical Working Group presented in Chapter V.)

An engineering study, as described in Chapter III, should be conducted to determine if the three types of sight distance can be provided as desired. If not, other alternatives should be considered. The highway speed might be reduced, through the installation of either an advisory or regulatory speed sign, to a level that conforms to the available sight distance. It is important that the motorist understand why the speed reduction is necessary, otherwise, it may be ignored unless enforced. At crossings with passive control devices only, consideration might be given to the installation of active traffic control devices that warn of the approach of a train.

2. Crossing Geometry

The ideal crossing geometry is a 90-degree intersection of track and highway with slight-ascending grades on both highway approaches to reduce the flow of surface water toward the crossing. Few crossings have this ideal geometry because of topography or limitations of right of way for both the highway and the railroad. Every effort should be made to construct new crossings in this manner. Horizontal and vertical alignment and cross-sectional design are discussed below.

¹⁰⁹ Ibid.

Table 41. Clearing Sight Distance (in feet)*

Train speed	Car	Single-unit truck	Bus	WB-50 semitruck	65-foot double truck	Pedestrian**
10	105	185	200	225	240	180
20	205	365	400	450	485	355
25	255	455	500	560	605	440
30	310	550	600	675	725	530
40	410	730	795	895	965	705
50	515	910	995	1,120	1,205	880
60	615	1,095	1,195	1,345	1,445	1,060
70	715	1,275	1,395	1,570	1,680	1,235
80	820	1,460	1,590	1,790	1,925	1,410
90	920	1,640	1,790	2,015	2,165	1,585

* A single track, 90-degree, level crossing.

** Walking 1.1 meters per second (3.5 feet per second) across two sets of tracks 15 feet apart, with a 2-second reaction time to reach a decision point 3 meters (10 feet) before the center of the first track, and clearing 3 meters (10 feet) beyond the centerline of the second track. Two tracks may be more common in commuter station areas where pedestrians are found.

Source: Guidance on Traffic Control Devices at Highway-Rail Grade Crossings. Washington, DC: Federal Highway Administration, Highway/Rail Grade Crossing Technical Working Group, November 2002.

Horizontal alignment. Desirably, the highway should intersect the tracks at a right angle with no nearby intersections or driveways. This layout enhances the driver’s view of the crossing and tracks and reduces conflicting vehicular movements from crossroads and driveways. To the extent practical, crossings should not be located on either highway or railroad curves. Roadway curvature inhibits a driver’s view of a crossing ahead, and a driver’s attention may be directed toward negotiating the curve rather than looking for a train. Railroad curvature inhibits a driver’s view down the tracks from both a stopped position at the crossing and on the approach to the crossing. Crossings located on both highway and railroad curves present maintenance problems and poor rideability for highway traffic due to conflicting superelevations. Similar difficulties arise when superelevation of the track is opposite to the grade of the highway.

If the intersection between track and highway cannot be made at right angles, the variation from 90 degrees should be minimized. One state limits the minimum skew to 70 degrees. At skewed crossings, motorists must look over their shoulder to view the tracks. Because of this more awkward movement, some motorists may only glance quickly and not take necessary precaution.

Generally, improvements to horizontal alignment are expensive. Special consideration should be given to

crossings that have complex horizontal geometries, as described previously. These crossings may warrant the installation of active traffic control systems or, if possible, may be closed to highway traffic.

Vertical alignment. It is desirable that the intersection of highway and railroad be made as level as possible from the standpoint of sight distance, rideability, and braking and acceleration distances. Drainage would be improved if the crossing were located at the peak of a long vertical curve on the highway. Vertical curves should be of sufficient length to ensure an adequate view of the crossing and consistent with the highway design or operating speed.

Track maintenance can result in raising the track as new ballast is added to the track structure. Unless the highway profile is properly adjusted, this practice will result in a “humped” profile that may adversely affect the safety and operation of highway traffic over the railroad.

Two constraints often apply to the maintenance of grade crossing profiles: drainage requirements and resource limitations. Coordination of maintenance activities between rail and highway authorities, especially at the city and county level, is frequently informal and unstructured. Even when the need to coordinate has been identified, there may be a lack of knowledge regarding whom to contact.

In some cases, highway authorities become aware of increases in track elevation (a by-product of track maintenance) only after the fact. As a result, even if state standards exist, there is little opportunity to enforce them. Often, an individual increase in track elevation may not violate a guideline, but successive track raises may create a high-profile crossing.

Low-clearance vehicles, such as those low to the ground relative to the distance between axles, pose the greatest risk of becoming immobilized at highway-rail grade crossings due to contact with the track or highway surface. With the exception of specialized vehicles such as tank trucks, there is little standardization within the vehicle manufacturing industry regarding minimum ground clearance. Instead, manufacturers are guided by the requirements of shippers and operators.¹¹⁰

A similar problem may arise where the crossing is in a sag vertical curve. In this instance, the front or rear overhangs on certain vehicles may strike or drag the pavement.¹¹¹

Alternatives to this problem include a design standard that deals with maximum grades at the crossing; prohibiting truck trailers with a certain combination of underclearance and wheelbase from using the crossing; setting trailer design standards; posting warning signs in advance of the crossing; minimizing the rise in track due to maintenance operations; or reconstructing the crossing approaches.¹¹²

The AREMA *Manual for Railway Engineering* recommends that the crossing surface be in the same plane as the top of rails for a distance of 600 millimeters (2 feet) outside of the rails, and that the surface of the highway be not more than 75 millimeters (3 inches) higher or lower than the top of the nearest rail at a point 7.5 meters (30 feet) from the rail, unless track superelevation dictates otherwise. This standard has been adopted by AASHTO in *A Policy on Geometric Design of Highways and Streets* (see Figure 56).¹¹³

110 "Accidents That Shouldn't Happen." A Report by the U.S. Department of Transportation (U.S. DOT) Task Force on Highway-Rail Crossing Safety to Transportation Secretary Federico Pena, March 1, 1996.

111 Eck, Ronald W. and S.K. Kang. "Low Clearance Vehicles at Grade Crossings." West Virginia University, 1992.

112 "Accidents That Shouldn't Happen." A Report by the U.S. DOT Task Force on Highway-Rail Crossing Safety to Transportation Secretary Federico Pena, March 1, 1996.

113 *A Policy on Geometric Design of Highways and Streets, 2004 Edition*. Washington, DC: American Association of State Highway

Eck and Kang surveyed a large number of low-clearance vehicles on an interstate route in West Virginia and also obtained vehicle length and ground clearance data from Oregon and other sites. Based on field and engineering data, they proposed a low-clearance vehicle for design purposes that would have an 11-meter (36-foot) wheelbase and a 125-millimeter (5-inch) ground clearance.¹¹⁴

Eck and Kang also identified and summarized a number of state and railroad crossing profile standards in addition to the AREMA and AASHTO criteria described above. Among them were:

- The Illinois Commerce Commission specifies that from the outer rail of the outermost track, the road surface should be level for about 600 millimeters (24 inches). From there, for a distance of 7.6 meters (25 feet), a maximum grade of 1 percent is specified. From there to the railroad right-of-way line, a maximum grade of 5 percent is specified.
- The Division of Highways in West Virginia recommends 3 meters (10 feet) of run-off length for every 25 millimeters (1 inch) of track raise.
- A standard developed by the Southern Pacific Railroad prior to its merger with Union Pacific recommends that for a distance of 6 meters (20 feet) from a point 2 feet from the near rail, the maximum descent should be 150 millimeters (6 inches). From that point, for a distance of another 6 meters, the maximum descent should be 600 millimeters (2 feet).
- Tennessee state law requires that the road be graded level with the rails for a distance of 3 meters (10 feet) on either side of the track and between the rails thereof.
- A number of European countries have developed geometric design guidelines for highway-rail grade crossings. Great Britain provides a circular curve roadway profile. There are three categories of radii depending on traffic volume and traffic "moment" (the product of vehicular and rail traffic).

Eck and Kang developed a software package for the analysis of crossing profiles. HANGUP was developed to simulate the movement of low-clearance vehicles on grade crossings. It is useful as an analysis tool for evaluating crossings where low-clearance vehicles or overhang dragging may be a problem.¹¹⁵ At the time of this writing, the program package was being updated.

and Transportation Officials, 2004.

114 Eck, Ronald W. and Kang, S. K. "Low Clearance Vehicles at Grade Crossings." West Virginia University, 1992.

115 Ibid.

Figure 56. Highway-Rail Grade Crossing Cross Section

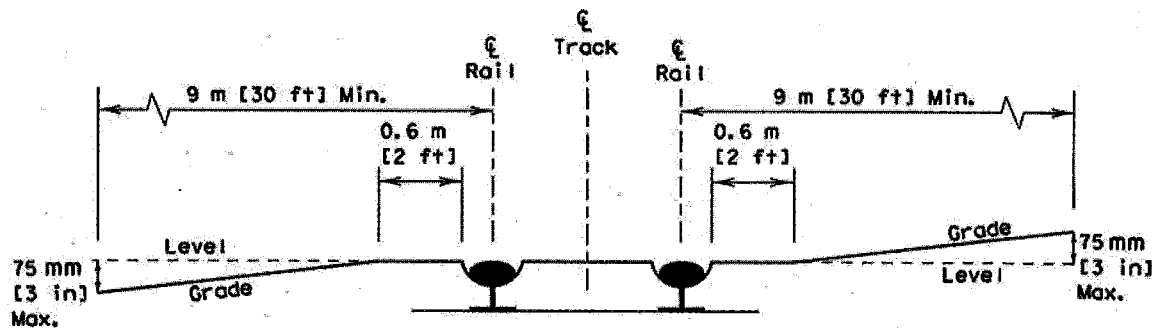

Source: From A Policy on Geometric Design of Highway and Streets, 2004, by the American Association of State Highway and Transportation Officials, Washington, DC. Used by permission.

Right of way and roadside (clear zone). The railroad and roadway rights of way at highway-rail grade crossings were usually purchased at the time the transportation facilities were built. Right-of-way restrictions frequently constrain the type and location of improvements that can be constructed. Within these rights of way, the area adjacent to the crossing should be kept as level and free from obstructions as possible, subject to the space required for traffic control devices.

Although every reasonable effort must be made to keep a vehicle on the roadway, railroad and highway engineers must acknowledge the fact that this goal will never be fully realized. Once a vehicle leaves the roadway, the probability of a collision occurring depends primarily on the speed and trajectory of the vehicle and what lies in its path. If a collision does occur, its severity is dependent upon several factors, including the use of restraint systems by vehicle occupants, the type of vehicle, and the nature of the roadside environment. Of these factors, the engineer generally has control over only one: the roadside environment.

Ideally, the roadside recovery area, or “clear zone,” should be free from obstacles such as unyielding sign and luminaire supports, non-traversable drainage structures, trees larger than 100 millimeters (4 inches) in diameter, utility or railroad line poles, or steep slopes. Design options for mitigating these features are generally considered in the following order:

- Remove the obstacle or redesign it so that it can be safely traversed.
- Relocate the obstacle to a point where it is less likely to be struck.
- Reduce impact severity by using an appropriate breakaway device.

- Redirect a vehicle by shielding the obstacle by use of a longitudinal barrier or crash cushion.
- Delineate the obstacle if the above alternatives are not appropriate.

Highway and railroad officials must cooperatively decide on the type of traffic control devices needed at a particular crossing. As a minimum, crossbucks are required and should be installed on an acceptable support. Other traffic control device supports, such as for flashers or gates, can cause an increase in the severity of injuries to vehicle occupants if struck at high speeds. In these cases, consideration should be given to shielding the support with a crash cushion if the support is located in the clear zone. Longitudinal barriers are not often used because there is seldom room for a proper downstream end treatment, a longer hazard is created by installing a guardrail, and a vehicle striking a longitudinal barrier when a train is occupying the crossing may be redirected into the train.¹¹⁶ A longitudinal guardrail should not be used at a crossing unless it is otherwise warranted, such as by a steep embankment.

A curb over 100 millimeters (4 inches) tall is not an acceptable treatment where speeds are high because it will cause vehicles to vault. Any curb (including one less than 4 inches tall) can cause vehicles to go airborne if struck at high speed. Curbs should be avoided on high-speed roads but, if needed, the curb can be located at the back of the shoulder. In some cases, curbs closer to the traveled way may be acceptable on a high-speed road where they fulfill an important function, such as blocking an illegal or undesirable traffic movement.

The purpose of a traffic barrier such as a guardrail is to protect the errant motorist by containing or redirecting

¹¹⁶ *Roadside Design Guide*, Washington, DC: AASHTO, 2002.

the vehicle. The purpose is not to protect traffic control devices against collision or possible damage. The ring type guardrail placed around a signal mast may create the same type of hazard as the mast itself; that is, the guardrail may be a roadside obstacle. These guardrails do, however, serve to protect the signal mast. Because functioning devices are vital to safety, the ring type guardrail may be used at locations with heavy traffic, such as an industrial area, and low traffic speeds.

More information can be obtained from the *Roadside Design Guide*, published by AASHTO.

3. Illumination

Illumination at a crossing may be effective in reducing nighttime collisions. Illuminating most crossings is technically feasible because more than 90 percent of all crossings have commercial power available. Illumination may be effective under the following conditions:

- Nighttime train operations.
- Low train speeds.
- Blockage of crossings for long periods at night.
- Collision history indicating that motorists often fail to detect trains or traffic control devices at night.
- Horizontal and/or vertical alignment of highway approach such that vehicle headlight beam does not fall on the train until the vehicle has passed the safe stopping distance.
- Long dark trains, such as unit coal trains.
- Restricted sight or stopping distance in rural areas.
- Humped crossings where oncoming vehicle headlights are visible under trains.
- Low ambient light levels.
- A highly reliable source of power.

Luminaires may provide a low-cost alternative to active traffic control devices on industrial or mine tracks where switching operations are carried out at night.

Luminaire supports should be placed in accordance with the principles in the *Roadside Design Guide* and NCHRP Report 350.¹¹⁷ If they are placed in the clear zone on a high-speed road, they should be breakaway.

4. Shielding Supports for Traffic Control Devices

The purpose of a traffic barrier, such as a guardrail or crash cushion, is to protect the motorist by redirecting

or containing an errant vehicle. The purpose is not to protect a traffic control device against collision and possible damage. The use of a traffic barrier should be limited to situations in which hitting the object, such as a traffic control device, is more hazardous than hitting the traffic barrier and, possibly, redirecting the vehicle into a train.

A longitudinal guardrail should not be used for traffic control devices at crossings unless the guardrail is otherwise warranted, as for a steep embankment. The longitudinal guardrail might redirect a vehicle into a train.

On some crossings, it may be possible to use crash cushions to protect the motorist from striking a traffic control device. Some crash cushions are designed to capture rather than redirect a vehicle and may be appropriate for use at crossings to reduce the redirection of a vehicle into the path of a train.

The ring type guardrail placed around a signal mast may create the same type of hazard as the signal mast itself (the guardrail may be a roadside obstacle). It does, however, serve to protect the signal mast. Because functioning devices are vital to safety, the ring type guardrail may be used at locations with heavy industrial traffic, such as trucks, and low highway speeds.

When a barrier is used, it should be installed according to the requirements in the *Guide for Selecting, Locating and Designing Traffic Barriers*.

M. Crossing Surfaces

In negotiating a crossing, the degree of attention the driver can be expected to devote to the crossing surface is related to the condition of that surface. If the surface is uneven, the driver's attention may be devoted primarily to choosing the smoothest path over the crossing rather than determining if a train is approaching the crossing. This type of behavior may be conditioned; that is, if a driver is consistently exposed to uneven crossing surfaces, he or she may assume that all crossing surfaces are uneven whether or not they actually are. Conversely, if a driver encounters an uneven surface unexpectedly, he or she may lose control of the vehicle, resulting in a collision. Therefore, providing reasonably smooth crossing surfaces is viewed as one of several elements toward improving crossing safety and operations.

The AREMA *Manual of Railway Engineering*, Part 8, provides guidelines for the construction and reconstruction of highway-rail crossings. The first section of Part 8 provides information

117 Ibid.

on crossing surface materials; crossing width; profile and alignment of crossings and approaches; drainage; ballast; ties; rail; flange widths; and new or reconstructed track through a crossing. Other sections in this chapter cover traffic control devices for highway-railway grade crossings; protecting highway-railway grade crossings and flangeways; types of barrier for dead-end streets; specifications for permanent number of boards for the U.S. DOT–American Association of Railroads highway-railway crossings inventory system; location of highways parallel with railways; and problems related to location and construction of limited-access highways in the vicinity of or crossing railways.

Originally, crossing surfaces were made by filling the area between the rails with sand and gravel, probably from the railroad ballast. Later, crossing surfaces were made of planks or heavier timbers or of bituminous material, sometimes using planks to provide the flangeway openings. Treated timber panels and prefabricated metal sections followed and, in 1954, the first proprietary rubber panel crossing surface was put on the market. Presently available proprietary surfaces, usually patented, are fabricated from concrete, rubber, steel, synthetics, wood, and various combinations of these materials.

Crossing surfaces available today can be divided into two general categories: monolithic and sectional. Monolithic crossings are formed at the crossing and cannot be removed without destroying them. Typical monolithic crossings are asphalt, poured-in-place concrete, and cast-in-place rubber (elastomeric) compounds. Sectional crossings are manufactured in sections (panels), are placed at the crossing, and can be removed and re-installed. These crossing surfaces facilitate the maintenance of track through the crossing. Typical sectional crossings consist of treated timbers, reinforced concrete, steel, high-density polyethylene, and rubber.

Proper preparation of the track structure and good drainage of the subgrade are essential to good performance from any type of crossing surface. Excessive moisture in the soil can cause track settlement, accompanied by penetration of mud into the ballast section. Moisture can enter the subgrade and ballast section from above, below, and/or adjacent subgrade areas. To the extent feasible, surface and subsurface drainage should be intercepted and discharged away from the crossing. Drainage can be facilitated by establishing an adequate difference in elevation between the crossing surfaces and ditches or embankment slopes. The highway profile at all crossings should be such that water drains away from the crossing.

N. Removal of Grade Separation Structures

There are approximately 34,000 public grade-separated highway-rail crossings in the United States. More than half of these grade-separated crossings have a bridge or highway structure over the railroad tracks. As these structures age, become damaged, or are no longer needed because of changes in highway or railroad alignment or use, alternative engineering decisions must be made. The alternatives to be considered are upgrading the existing structure to new construction standards; replacing the existing structure; removing the structure, leaving an at-grade crossing; and closing the crossing and removing the structure.

In general, crossing programs are based upon criteria established for the installation of traffic control devices or the elimination of a crossing. However, rehabilitation of structures is a significant part of the crossing improvement program at both the state and the national level. Currently, there are no nationally recognized guidelines for evaluating the alternatives available for the improvement or replacement of grade-separation structures.

Some states have developed evaluation methods for the selection of projects to remove grade-separation structures. Following is a summary of the state of Pennsylvania guidance.

The purpose of the Pennsylvania guidance is to assist highway department personnel in the selection of candidate bridge removal projects where the railroad line is abandoned. Both bridges carrying highway over railroad and bridges carrying abandoned railroad over highway can be considered. The factors to be considered in selecting candidate projects are as follows:

For bridges carrying highway over an abandoned railroad:

- Bridges that are closed or posted for a weight limit because of structural deficiencies (the length of the necessary detour is important).
- Bridges that are narrow and, therefore, hazardous.
- Bridges with hazardous vertical and/or horizontal alignment of the highway approaches (accident records can be reviewed to verify such conditions).

For bridges carrying abandoned railroad over a highway:

- Bridges that are structurally unsound and a hazard to traffic operating under the bridge.

- Bridges whose piers and/or abutments are in close proximity to the traveled highway and constitute a hazard.
- Bridges whose vertical clearance over the highway is substandard.
- Bridges where the vertical and/or horizontal alignment of the highway approaches are hazardous primarily because of the location of the bridge.

It should be noted that this guidance is applicable to situations that involve abandoned rail lines.

In those instances where a railroad continues to operate, other decisions must be made. Some considerations for removing a grade separation over or under a rail line that is still being operated are as follows:

- Can the structure be removed and replaced with an at-grade crossing?
- Who is liable if an accident occurs at the new at-grade crossing?
- If the structure is to be rebuilt, who is to pay the cost or who is to share in the cost and to what extent?
- To what standards is the structure to be rebuilt?
- What is the future track use and potential for increase in train frequency?
- If the structure is replaced with an at-grade crossing, what delays to motorists and emergency service will result? Are alternate routes available?
- What impact will an at-grade crossing have on railroad operations?
- What will be the impact on safety of an at-grade crossing versus a structure?

To ensure a proper answer to these and other related questions, an engineering evaluation, including relative costs, should be conducted. This evaluation should follow procedures described in Chapter V.

O. References

American National Standard Practices for Roadway Lighting. New York, New York: Illuminating Engineering Society of America, July 1977.

Code of Federal Regulations, Title 23, Washington, DC: General Services Administration, published annually.

Collision of Amtrak Train No. 88 with Tractor Lowboy Semitrailer Combination Truck, Rowland, N.C., August 25, 1983. Washington, DC: National Transportation Safety Board, Report No. NTSB/RHR-84/01, 1984.

The Effectiveness of Automatic Protection in Reducing Accident Frequency and Severity at Public Grade Crossings in California. San Francisco, California: California Public Utilities Commission, June 1974.

Federal-Aid Policy Guide Program Manual. Washington, DC: Federal Highway Administration (FHWA), updated periodically.

Federal Highway Administration Survey of Region and Division Offices, unpublished, 1984.

Data from the U.S. DOT National Rail-Highway Crossing Inventory, Federal Railroad Administration (FRA), 1984.

Field and Office Manual for Profile Surveys of Highway-Rail At-Grade Crossings on Existing Paved Roadways. Tallahassee, Florida: Florida Department of Transportation, September 1984.

Fitzpatrick, Gary M. *Standardization of Criteria for Rail/Highway Grade Crossing Construction*. Tallahassee, Florida: Florida Department of Transportation, Office of Value Engineering, August 1982.

Guide for Selecting, Locating, and Designing Traffic Barriers. Washington, DC: American Association of State Highways and Transportation Officials, 1977.

Heathington, K.W. and T. Urbanik. "Driver Information Systems for Highway-Railway Grade Crossings." *Highway Research Record*, No. 414. Washington, DC: Highway Research Board, 1972.
Hedley, William J. *Proceedings, American Railway Engineering and Maintenance-of-Way Association*, Vol. 53, Chicago, Illinois, 1952.

Hedley, William J. *Railroad-Highway Grade Crossing Surfaces*. Washington, DC: FHWA, August 1979.

Illinois Commerce Commission General Order No. 138, Revised. Springfield, Illinois: Illinois Commerce Commission, 1973.

Knoblauch, Karl, Wayne Hucke, and William Berg. *Rail Highway Crossing Accident Causation Study. Volume II, Technical Report*. Washington, DC: FHWA, Report FHWA/RD-81/083, August 1982.

Manual for Railway Engineering. Washington, DC: American Railway Engineering and Maintenance-of-Way Association, 1981.

Manual on Uniform Traffic Control Devices, 2003 Edition. Washington, DC: FHWA, 2003.

Mather, Richard A. *Public Railroad-Highway Grade Crossing Illumination Project in Oregon*. Washington, DC: Transportation Research Board, January 1983.

Monroe, Richard L., Debra K. Munsell, and T. James Rudd. *Constant Warning Time Concept Development for Motorist Warning at Grade Crossings*. Washington, DC: FRA, Report FRA/ORD-81/07, May 1981.

Morrissey, J. *The Effectiveness of Flashing Lights and Flashing Lights with Gates in Reducing Accident Frequency at Public Rail-Highway Crossings, 1975-1978*. Washington, DC: FRA and FHWA, April 1980.
A Policy on Geometric Design of Highway and Streets. Washington, DC: American Association of State Highway and Transportation Officials, 1984.

Proceedings, National Conference on Railroad-Highway Crossing Safety, Colorado Springs, Colorado, U.S. Air Force Academy Interim Education Center, August 1974.

Proceedings, National Conference on Railroad-Highway Crossing Safety, Salt Lake City, Utah, University of Utah, August 1977.

Proceedings, National Rail-Highway Crossing Safety Conference, Knoxville, Tennessee, The University of Tennessee, June 1980.

Rail-Highway Grade Crossing Warning Systems and Surfaces. Alexandria, Virginia: The Railway Progress Institute, 1983.

Roadway Lighting Handbook. Washington, DC: FHWA, Implementation Package 7815, December 1978.

Ruden, Robert J., Albert Burg, and John P. McGuire. *Activated Advance Warning for Railroad Grade Crossings*. Washington, DC: FHWA, Report FHWA/RD-80/003, July 1982.

Standard Alphabet for Highway Signs and Markings. Washington, DC: FHWA.

Traffic Control Devices Handbook. Washington, DC: FHWA, 1983.

Uniform Vehicle Code and Model Traffic Ordinance. National Committee of Uniform Traffic Laws and Ordinances, Charlottesville, Virginia: The Michie Company, 1961 and Supplement, 1979.

“Use of Traffic Divisional Islands at Railroad Grade Crossings.” *Technical Notes 84-1*. Albany, New York: New York Department of Transportation, March 1984.

West Virginia's Highway-Railroad Manual. Charleston, West Virginia: West Virginia Department of Highways, Railroad Section, Right of Way Division, preliminary, 1984.

Selection of Alternatives



This chapter discusses methods for selecting alternatives and the economic analysis techniques that may be utilized. Although procedures are provided for developing benefit-cost analyses of alternative treatments, more recent trends place emphasis on risk avoidance and best practices. As a result, benefit-cost studies may only be useful for evaluating alternatives that involve a major investment. Benefit-cost analysis requirements are contained in 23 CFR 924. In addition, the Rail-Highway Crossing Resource Allocation Procedure is presented and other low-cost solutions are discussed.

A. Technical Working Group Guidance on Traffic Control Devices—Selection Criteria and Procedure

The Technical Working Group (TWG) established by the U.S. Department of Transportation (U.S. DOT) is led by representatives from the Federal Highway Administration (FHWA), Federal Railroad Administration (FRA), Federal Transit Administration, and National Highway Traffic Safety Administration. This cooperation among the various representatives of TWG represents a landmark effort to enhance communication among highway agencies, railroad companies and authorities, and governmental agencies involved in developing and implementing policies, rules, and regulations.

The TWG document is intended to provide guidance to assist engineers in the selection of traffic control devices or other measures at highway-rail grade crossings.¹¹⁸ It is not to be interpreted as policy or standards and is not mandatory. Any requirements that may be

noted in the report are taken from the *Manual on Uniform Traffic Control Devices* (MUTCD) or another document identified by footnotes. A number of measures are included that may not have been supported by quantitative research but are being used by states and local agencies. These are included to inform practitioners of the array of tools being used or explored.

The introductory materials developed by the U.S. DOT TWG present an excellent perspective on the functioning of a highway-rail grade crossing. TWG notes that a highway-rail grade crossing differs from a highway-highway intersection in that the train always has the right of way. From this perspective, TWG indicates that the process for deciding what type of highway traffic control device is to be installed or even allowing that a highway-rail grade crossing should exist is essentially a two-step process, requiring consideration of what information the vehicle driver needs to be able to cross safely and whether the resulting driver response to a traffic control device is “compatible” with the intended system operating characteristics of the highway and railroad facility.

The TWG guidance outlines the technical considerations for satisfying motorist needs, including the role of stopping sight distance, approach (corner) sight distance, and clearing sight distance, and integrates this with highway system needs based upon the type and classification of the roadway as well as the allowable track speeds by class of track for the railway system. This handbook describes tools and analytical methodologies as well as treatments and criteria from a variety of sources for selecting treatments; the TWG document and its introduction should be consulted by persons involved with studies of grade crossing safety issues and improvements.

These treatments are provided for consideration at every public highway-rail grade crossing. Specific MUTCD signs and treatments are included for easy reference.

118 *Guidance on Traffic Control Devices at Highway-Rail Grade Crossings*. Washington, DC: Federal Highway Administration (FHWA), Highway/Rail Grade Crossing Technical Working Group, November 2002.

TECHNICAL WORKING GROUP GUIDANCE

1. Minimum Devices

All highway-rail grade crossings of railroads and public streets or highways should be equipped with approved passive devices. For street-running railroads/transit systems, refer to MUTCD Parts 8 and 10.

2. Minimum Widths

All highway-rail grade crossing surfaces should be a minimum of 1 foot beyond the edge of the roadway shoulder, measured perpendicular to the roadway centerline, and should provide for any existing pedestrian facilities.

3. Passive—Minimum Traffic Control Applications

- a. A circular railroad advance warning (W10-1) sign shall be used on each roadway in advance of every highway-rail grade crossing except as described in MUTCD.
- b. An emergency phone number should be posted at the crossing, including the U.S. DOT highway-rail grade crossing identification number, highway or street name or number, railroad milepost, and other pertinent information.
- c. Where the roadway approaches to the crossing are paved, pavement markings are to be installed as described in MUTCD, subject to engineering evaluation.
- d. Where applicable, the “Tracks Out Of Service” sign should be placed to notify drivers that track use has been discontinued.
- e. One reflectorized crossbuck sign shall be used on each roadway approach to a highway-rail grade crossing.
 - i. If there are two or more tracks, the number of tracks shall be indicated on a supplemental sign (R15-2) of inverted T shape mounted below the crossbuck.
 - ii. Strips of retroreflective white material not less than 2 inches in width shall be used on the back of each blade of each crossbuck sign for the length of each blade, unless the crossbucks are mounted back to back.
 - iii. A strip of retroreflective white material not less than 2 inches in width shall be used on the full length of the front and back of each support from the crossbuck sign to near ground level or just above the top breakaway hole on the post.
- f. Supplemental passive traffic control applications (subject to engineering evaluation):
 - i. Inadequate stopping sight distance:
 - a. Improve the roadway geometry.
 - b. Install appropriate warning signs (including consideration of active types).
 - c. Reduce the posted roadway speed in advance of the crossing:
 - i. Advisory signing as a minimum.
 - ii. Regulatory posted limit if it can be effectively enforced.

- d. Close the crossing.
 - e. Reconfigure/relocate the crossing.
 - f. Grade separate the crossing.
- ii. Inadequate approach (corner) sight distance (assuming adequate clearing sight distance):
- a. Remove the sight distance obstruction.
 - b. Install appropriate warning signs.
 - c. Reduce the posted roadway speed in advance of the crossing:
 - i. Advisory signing as a minimum.
 - ii. Regulatory posted limit if it can be effectively enforced.
 - d. Install a YIELD (R1-2) sign, with advance warning sign (W3-2a) where warranted by MUTCD (restricted visibility reduces safe approach speed to 16–24 kilometers per hour (10–15 miles per hour)).
 - e. Install a STOP (R1-1) sign, with advance warning sign (W3-1a) where warranted by MUTCD (restricted visibility requires drivers to stop at the crossing).
 - f. Install active devices.
 - g. Close the crossing.
 - h. Reconfigure/relocate the crossing.
 - i. Grade separate the crossing.
- iii. Deficient clearing sight distances (for one or more classes of vehicles):
- a. Remove the sight distance obstruction.
 - b. Permanently restrict use of the roadway by the class of vehicle not having sufficient clearing sight distance.
 - c. Install active devices with gates.
 - d. Close the crossing.
 - e. Reconfigure/relocate the crossing.
 - f. Grade separate the crossing.
 - g. Multiple railroad tracks and/or two or more highway approach lanes in the same direction should be evaluated with regard to possible sight obstruction from other trains (moving or standing on another track or siding) or highway vehicles.
- iv. Stopping and corner sight distance deficiencies may be treated immediately with warning or regulatory traffic control signs, such as a STOP sign, with appropriate advance warning signs. However, until such time as permanent corrective measures are implemented to correct deficient clearing sight distance, interim measures should be taken, which may include:
- a. Temporarily close the crossing.
 - b. Temporarily restrict use of the roadway by the classes of vehicles.

Table 42. Guidelines for Active Devices

Class of track	Maximum allowable operating speed for freight trains—minimum active devices		Maximum allowable operating speed for passenger trains—minimum active devices	
	Speed	Device	Speed	Device
Excepted track	10 mph	Flashers	N/A	N/A
Class 1 track	10 mph	Flashers	15 mph	Gates*
Class 2 track	25 mph	Flashers	30 mph	Gates*
Class 3 track	40 mph	Gates	60 mph**	Gates**
Class 4 track	60 mph	Gates	80 mph	Gates
Class 5 track	80 mph	Gates plus supplemental safety devices	90 mph	Gates plus supplemental safety devices
Class 6 track	110 mph with conditions	Gates plus supplemental safety devices	110 mph	Gates plus supplemental safety devices
Class 7 track	125 mph with conditions	Full barrier protection	125 mph	Full barrier protection
Class 8 track	160 mph with conditions	Grade separation	160 mph	Grade separation
Class 9 track	200 mph with conditions	Grade separation	200 mph	Grade separation

Note: 1 mile per hour (mph) = 1.61 kilometers per hour (km/hr.)

** Refer to the 2003 edition of MUTCD, Part 10, transit and light-rail trains in medians of city streets.*

*** Except 35 mph (56 km/hr.) for transit and light-rail trains.*

Source: Guidance on Traffic Control Devices at Highway-Rail Grade Crossings. Washington, DC: Federal Highway Administration, Highway/Rail Grade Crossing Technical Working Group, November 2002.

4. Active

If active devices are selected, the following devices should be considered:

- a. Active devices with automatic gates should be considered at highway-rail grade crossings whenever an engineering study by a diagnostic team determines one or more of the following conditions exist:
 - i. All crossings on the National Highway System, “U.S.” marked routes, or principal arterials not otherwise grade separated.
 - ii. If inadequate clearing sight distance exists in one or more approach quadrants, AND it is determined ALL of the following apply:
 - a. It is not physically or economically feasible to correct the sight distance deficiency.
 - b. An acceptable alternate access does not exist.
 - c. On a life-cycle cost basis, the cost of providing acceptable alternate access or grade separation would exceed the cost of installing active devices with gates.
 - iii. Regularly scheduled passenger trains operate in close proximity to industrial facilities, such as stone quarries, log mills, cement plants, steel mills, oil refineries, chemical plants, and land fills.

- iv. In close proximity to schools, industrial plants, or commercial areas where there is substantially higher than normal usage by school buses, heavy trucks, or trucks carrying dangerous or hazardous materials.
 - v. Based upon the number of passenger trains and/or the number and type of trucks, a diagnostic team determines a significantly higher than normal risk exists that a train-vehicle collision could result in death of or serious injury to rail passengers.
 - vi. Multiple main or running tracks through the crossing.
 - vii. The expected accident frequency for active devices without gates, as calculated by the U.S. DOT Accident Prediction Formula including five-year accident history, exceeds 0.1.
 - viii. In close proximity to a highway intersection or other highway-rail crossings and the traffic control devices at the nearby intersection cause traffic to queue on or across the tracks (in such instances, if a nearby intersection has traffic signal control, it should be interconnected to provide preempted operation, and consider traffic signal control, if none).
 - ix. As otherwise recommended by an engineering study or diagnostic team.
- b. Active devices with automatic gates should be considered as an option at public highway-rail grade crossings whenever they can be economically justified based on fully allocated life-cycle costs and one or more of the following conditions exist:
- i. Multiple tracks exist at or in the immediate crossing vicinity where the presence of a moving or standing train on one track effectively reduces the clearing sight distance below the minimum relative to a train approaching the crossing on an adjacent track (absent some other acceptable means of warning drivers to be alert for the possibility of a second train).
 - ii. An average of 20 or more trains per day.
 - iii. Posted highway speed exceeds 64 km/hr. (40 mph) in urban areas or exceeds 88 km/hr. (55 mph) in rural areas.
 - iv. Annual average daily traffic (AADT) exceeds 2,000 in urban areas or 500 in rural areas.
 - v. Multiple lanes of traffic in the same direction of travel (usually this will include cantilevered signals).
 - vi. The crossing exposure (the product of the number of trains per day and AADT) exceeds 5,000 in urban areas or 4,000 in rural areas.
 - vii. The expected accident frequency as calculated by the U.S. DOT Accident Prediction formula, including five-year accident history, exceeds 0.075.
 - viii. An engineering study indicates that the absence of active devices would result in the highway facility performing at a level of service below level C.
 - ix. Any new project or installation of active devices to significantly replace or upgrade existing non-gated active devices. For purposes of this item, replacements or upgrades should be considered “significant” whenever the cost of the otherwise intended improvement (without gates) equals or exceeds one-half the cost of a comparable new installation, and should exclude maintenance replacement of individual system components and/or emergency replacement of damaged units.
 - x. As otherwise recommended by an engineering study or diagnostic team.
- c. Warning/barrier gate systems should be considered as supplemental safety devices at:
- i. Crossings with passenger trains;
 - ii. Crossings with high-speed trains;
 - iii. Crossings in quiet zones; or
 - iv. As otherwise recommended by an engineering study or diagnostic team.
- d. Enhancements for pedestrian treatments:
- i. Design to avoid stranding pedestrians between sets of tracks.
 - ii. Add audible devices, based on an engineering study.

- iii. Consider swing gates carefully; the operation of the swing gate should be consistent with the requirements of the Americans with Disabilities Act; the gate should be checked for pedestrian safety within the limits of its operation.
- iv. Provide for crossing control at pedestrian crossings where a station is located within the proximity of a crossing or within the crossing approach track circuit for the highway-rail crossing.
- v. Utilize a Train-to-Wayside Controller to reduce traffic delays in areas of stations.
- vi. Delay the activation of the gates, flashers, and bells for a period of time at the highway-rail grade crossing in station areas, based on an engineering study.

5. Closure

Highway-rail grade crossings should be considered for closure and vacated across the railroad right of way whenever one or more of the following apply:

- a. An engineering study determines a nearby crossing otherwise required to be improved or grade separated already has acceptable alternate vehicular access, and pedestrian access can continue at the subject crossing, if existing.
- b. On a life-cycle cost basis, the cost of implementing the recommended improvement would exceed the cost of providing an acceptable alternate access.
- c. If an engineering study determines any of the following apply:
 - i. FRA Class 1, 2, or 3 track with daily train movements:
 - a. AADT less than 500 in urban areas, acceptable alternate access across the rail line exists within .4 km (one-quarter-mile), and the median trip length normally made over the subject crossing would not increase by more than .8 km (one-half-mile).
 - b. AADT less than 50 in rural areas, acceptable alternate access across the rail line exists within .8 km (one-half-mile), and the median trip length normally made over the subject crossing would not increase by more than 2.4 km (1.5 miles).
 - ii. FRA Class 4 or 5 track with active rail traffic:
 - a. AADT less than 1,000 in urban areas, acceptable alternate access across the rail line exists within .4 km (one-quarter-mile), and the median trip length normally made over the subject crossing would not increase by more than 1.2 km (three-quarters-mile).
 - b. AADT less than 100 in rural areas, acceptable alternate access across the rail line exists within 1.61 km (1 mile), and the median trip length normally made over the subject crossing would not increase by more than 4.8 km (3 miles).
 - iii. FRA Class 6 or higher track with active rail traffic, AADT less than 250 in rural areas, an acceptable alternate access across the rail line exists within 2.4 km (1.5 miles), and the median trip length normally made over the subject crossing would not increase by more than 6.4 km (4 miles).
- d. An engineering study determines the crossing should be closed to vehicular and pedestrian traffic when railroad operations will occupy or block the crossing for extended periods of time on a routine basis and it is determined that it is not physically or economically feasible to either construct a grade separation or shift the train operation to another location. Such locations would typically include:
 - i. Rail yards.
 - ii. Passing tracks primarily used for holding trains while waiting to meet or be passed by other trains.

- iii. locations where train crews are routinely required to stop their trains because of cross traffic on intersecting rail lines or to pick up or set out blocks of cars or switch local industries en route.
- iv. switching leads at the ends of classification yards.
- v. where trains are required to “double” in or out of yards and terminals.
- vi. in the proximity of stations where long distance passenger trains are required to make extended stops to transfer baggage, pick up, or set out equipment or be serviced en route.
- vii. locations where trains must stop or wait for crew changes.

6. Grade Separation

- a. Highway-rail grade crossings should be considered for grade separation or otherwise eliminated across the railroad right of way whenever one or more of the following conditions exist:
 - i. The highway is a part of the designated Interstate Highway System.
 - ii. The highway is otherwise designed to have full controlled access.
 - iii. The posted highway speed equals or exceeds 113 km/hr. (70 mph).
 - iv. AADT exceeds 100,000 in urban areas or 50,000 in rural areas.
 - v. Maximum authorized train speed exceeds 177 km/hr. (110 mph).
 - vi. An average of 150 or more trains per day or 300 million gross tons per year.
 - vii. An average of 75 or more passenger trains per day in urban areas or 30 or more passenger trains per day in rural areas.
 - viii. Crossing exposure (the product of the number of trains per day and AADT) exceeds 1 million in urban areas or 250,000 in rural areas; or
 - ix. Passenger train crossing exposure (the product of the number of passenger trains per day and AADT) exceeds 800,000 in urban areas or 200,000 in rural areas.
 - x. The expected accident frequency for active devices with gates, as calculated by the U.S. DOT Accident Prediction Formula including five-year accident history, exceeds 0.5.
 - xi. Vehicle delay exceeds 40 vehicle hours per day.¹
- b. Highway-rail grade crossings should be considered for grade separation across the railroad right of way whenever the cost of grade separation can be economically justified based on fully allocated life-cycle costs and one or more of the following conditions exist:
 - i. The highway is a part of the designated National Highway System.
 - ii. The highway is otherwise designed to have partial controlled access.
 - iii. The posted highway speed exceeds 88 km/hr. (55 mph).
 - iv. AADT exceeds 50,000 in urban areas or 25,000 in rural areas.
 - v. Maximum authorized train speed exceeds 161 km/hr. (100 mph).
 - vi. An average of 75 or more trains per day or 150 million gross tons per year.
 - vii. An average of 50 or more passenger trains per day in urban areas or 12 or more passenger trains per day in rural areas.
 - viii. Crossing exposure (the product of the number of trains per day and AADT) exceeds 500,000 in urban areas or 125,000 in rural areas; or
 - ix. Passenger train crossing exposure (the product of the number of passenger trains per day and AADT) exceeds 400,000 in urban areas or 100,000 in rural areas.

¹ *Guidance on Traffic Control Devices at Highway-Rail Grade Crossings*. Washington, DC: Federal Highway Administration (FHWA), Highway/Rail Grade Crossing Technical Working Group, November 2002.

- x. The expected accident frequency for active devices with gates, as calculated by the U.S. DOT Accident Prediction Formula including five-year accident history, exceeds 0.2.
 - xi. Vehicle delay exceeds 30 vehicle hours per day.
 - xii. An engineering study indicates that the absence of a grade separation structure would result in the highway facility performing at a level of service below its intended minimum design level 10 percent or more of the time.
- c. Whenever a new grade separation is constructed, whether replacing an existing highway-rail grade crossing or otherwise, consideration should be given to the possibility of closing one or more adjacent grade crossings.
 - d. Utilize Table 43 for LRT grade separation:

Table 43. LRT Grade Separation

Trains per hour	Peak-hour volume (vehicles per lane)
40	900
30	1000
20	1100
10	1180
5	1200

Source: *Light Rail Transit Grade Separation Guidelines, An Informational Report*. Washington, DC: Institute of Transportation Engineers, Technical Committee 6A-42, March 1992.

7. New Crossings

- a. Should only be permitted to cross existing railroad tracks at grade when it can be demonstrated:
 - i. For new public highways or streets where there is a clear and compelling public need (other than enhancing the value or development potential of the adjoining property);
 - ii. Grade separation cannot be economically justified, i.e. benefit-to-cost ratio on a *fully allocated* cost basis is less than 1.0 (generally, when the crossing exposure exceeds 50,000 in urban areas or exceeds 25,000 in rural areas); and
 - iii. There are no other viable alternatives.
- b. If a crossing is permitted, the following conditions should apply:
 - i. If it is a main track, the crossing will be equipped with active devices with gates.
 - ii. The plans and specifications should be subject to the approval of the highway agency having jurisdiction over the roadway (if other than a state agency), the state department of transportation or other state agency vested with the authority to approve new crossings, and the operating railroad.
 - iii. All costs associated with the construction of the new crossing should be borne by the party or parties requesting the new crossing, including providing financially for the ongoing maintenance of the crossing surface and traffic control devices where no crossing closures are included in the project.
 - iv. Whenever new public highway-rail crossings are permitted, they should fully comply with all applicable provisions of this proposed recommended practice.
 - v. Whenever a new highway-rail crossing is constructed, consideration should be given to closing one or more adjacent crossings.

8. Traffic Control Device Selection Procedure

Step 1—Minimum highway-rail grade crossing criteria (see report for full description):

- a. Gather preliminary crossing data:
 - i. Highway:
 - a. Geometric (number of approach lanes, alignment, median).
 - b. AADT.
 - c. Speed (posted limit or operating).
 - d. Functional classification.
 - e. Desired level of service.
 - f. Proximity of other intersections (note active device interconnection).
 - g. Availability and proximity of alternate routes and/or crossings.
 - ii. Railroad:
 - a. Number of tracks (type: FRA classification, mainline, siding, spur).
 - b. Number of trains (passenger, freight, other).
 - c. Maximum train speed and variability.
 - d. Proximity of rail yards, stations, and terminals.
 - e. Crossing signal control circuitry.
 - iii. Traffic control device:
 - a. Passive or active.
 - b. Advance.
 - c. At crossing.
 - d. Supplemental.
 - iv. Prior collision history
- b. Based on one or more of the above, determine whether any of the recommended thresholds for closure, installing active devices (if passive), or separation have been met based on highway or rail system operational requirements.
- c. Consider crossing closure or consolidation:
 - i. If acceptable alternate route(s) is/are available; or
 - ii. If an adjacent crossing is improved, can this crossing be closed? or
 - iii. If this crossing is improved, can an adjacent crossing be closed?
- d. For all crossings, evaluate stopping and clearing sight distances. If the conditions are inadequate for the existing control device, correct or compensate for the condition (see Step 3 below).
- e. If a passive crossing, evaluate corner sight distance. If less than the required for the posted or legal approach speed, correct or compensate for the condition (see Step 3 below).

Step 2—Evaluate highway traffic flow characteristics:

- a. Consider the required motorist response to the existing (or proposed) type of traffic control device. At passive crossings, determine the degree to which traffic may need to slow or stop based on evaluation of available corner sight distances.

- b. Determine whether the existing (or proposed) type of traffic control device and railroad operations will allow highway traffic to perform at an acceptable level of service for the functional classification of the highway.

Step 3—Possible revision to the highway-rail grade crossing:

- a. If there is inadequate sight distance related to the type of control device, consider measures such as:
 - i. Try to correct the sight distance limitation.
 - ii. If stopping sight distance is less than “ideal” for the posted or operating vehicle approach speed and cannot be corrected, determine the safe approach speed and consider either posting an advisory speed plate at the advance warning sign or reduce the regulatory speed limit on the approach.
 - iii. If corner sight distance is inadequate and cannot be corrected, determine the safe approach speed and consider posting an advisory speed plate at the advance warning sign, or reduce the regulatory speed limit on the approach, or install STOP or YIELD signs at the crossing.
 - iv. If clearing sight distance is inadequate, upgrade a passive or flashing light-only traffic control device to active with gates, or close (consolidate) the crossing, or grade separate.
- b. If highway and/or train volumes and/or speeds will not allow the highway to perform at an acceptable level of service, consider traffic control device upgrade to active (possibly with additional devices such as gates and medians), or closure (consolidation), or separation.
- c. If crossing closure or consolidation is being considered, determine the feasibility and cost of providing of an acceptable alternate route and compare this to the feasibility and cost of improving the existing crossing.
- d. If grade separation is being considered:
 - i. Economic analysis should consider fully allocated life-cycle costs.
 - ii. Consider highway classification and level of service.
 - iii. Consider the possibility of closing one or more adjacent grade crossings.

Step 4—Interim measures and/or documentation:

- a. If the above analysis indicates a change or improvement in the crossing or type of traffic control devices, determine what, if any, interim measures can or should be taken until such time as recommended improvement can be implemented.
- b. If the above analysis indicates a change or improvement in the crossing or type of traffic control devices, but there are other compelling reasons or circumstances for not implementing them, document the reasons and circumstances for your decision.
- c. If the above analysis indicates no change or improvement in the crossing or type of traffic control devices, document the fact that the crossing was evaluated and determined to be adequate.²

² Ibid.

B. Guidance on STOP and YIELD Signs

The National Committee on Uniform Traffic Control Devices (NCUTCD) has recommended revising MUTCD to mandate the use of YIELD signs at passive crossings except when STOP signs are determined appropriate by engineering study or engineering judgment. NCUTCD's recommendation is based on National Cooperative Highway Research Program Report 470, *Traffic-Control Devices for Passive Railroad-Highway Grade Crossings*. FHWA will consider proposing changes regarding the use of YIELD or STOP signs at passive grade crossings in the next edition of MUTCD. FHWA issued a guidance memo on March 17, 2006, which provided installation details and further instructs FHWA field personnel to work with local authorities to implement the use of YIELD signs (or STOP signs, where appropriate) at passive grade crossings.

It is recommended that YIELD signs be considered the default choice for traffic control at a passive crossing unless an engineering study or judgment determines that a STOP sign is appropriate. A STOP sign establishes a legal requirement for each and every vehicle to come to a full stop. Indiscriminate use of the STOP sign at all or many passive grade crossings can cause poor compliance, increasing the risk of collisions associated with a high non-compliance rate.

Therefore, the use of STOP signs at passive crossings should be limited to unusual conditions, where requiring all vehicles to make a full stop is deemed essential by engineering study or judgment. The engineering study or engineering judgment should consider:

- The line of sight from an approaching highway vehicle to an approaching train.
- Characteristics of the highway, such as the functional classification, geometric conditions, and traffic volumes and speed.
- Characteristics of the railroad, including but not limited to frequency, type, speed of trains, and number of tracks.
- Crossing crash history.
- Need for active control devices.

It should be noted that certain commercial motor vehicles and school buses are required to stop at all highway-rail grade crossings, in accordance with 49 CFR 392.10, even if a YIELD sign or just a crossbuck sign is posted.

C. Canadian Research on Cost Effectiveness

Canadian research includes evaluation of the tradeoffs between benefits and costs and takes into consideration the human factors in relation to effectiveness, as shown in Table 44.

D. Economic Analysis Procedures

An economic analysis may be performed to determine the possible alternative improvements that could be made at a highway-rail grade crossing. These procedures involve estimates of expected project costs and safety and operational benefits for each alternative. Much of the following discussion is adapted from the methodology presented in the *Highway Safety Improvement Program User's Manual*.

Initially, information on the following elements must be established, using the best available facts and estimates:

- Collision costs.
- Interest rates.
- Service life.
- Initial improvement costs.
- Maintenance costs.
- Salvage value.
- Traffic growth rates.

Other considerations include the effectiveness of the improvement in reducing collisions and the effects on travel, such as reducing delays.

Cost information is not always readily available. Therefore, some states are reluctant to impute a dollar cost to human life or personal injury. Considerable care must be used in establishing values for these costs.

The selection of collision cost values is of major importance in economic analyses. The two most common sources of collision costs are:

- National Safety Council (NSC).
- National Highway Traffic Safety Administration (NHTSA).

NSC costs include wage losses, medical expenses, insurance administrative costs, and property damage. NHTSA includes the calculable costs associated with each fatality and injury plus the cost to society, such as

Table 44. Countermeasure Type, Effectiveness, and Cost

Countermeasure	Effectiveness	Cost
STOP signs at passive crossings	Unknown	\$1,200 to \$2,000
Intersection lighting	52-percent reduction in nighttime collisions over no lighting	Unknown
Flashing lights	64-percent reduction in collisions over crossbucks alone	\$20,000 to \$30,000 in 1988
	84-percent reduction in injuries over crossbucks	
	83-percent reduction in deaths over crossbucks	
Lights and gates (two with flashing lights)	88-percent reduction in collisions over crossbucks alone	\$150,000
	93-percent reduction in injuries over crossbucks	
	100-percent reduction in deaths over crossbucks	
	44-percent reduction in collisions over flashing lights alone	
Median barriers	80-percent reduction in violations over two-gate system	\$10,000
Long arm gates (three-quarters of roadway covered)	67 to 84-percent reduction in violations over two-gate system	Unknown
Four-quadrant gate system	82-percent reduction in violations over two-gate system	\$125,000 from standard gates \$250,000 from passive crossing
Four-quadrant gate system with median barriers	92-percent reduction in violations over two-gate system	\$135,000
Crossing closure	100-percent reduction in violations, collisions, injuries, deaths	\$15,000
Photo/video enforcement	34 to 94-percent reduction in violations	\$40,000 to \$70,000 per installation
In-vehicle crossing safety advisory warning systems	Unknown	\$5,000 to \$10,000 per crossing plus \$50 to \$250 for a receiver

Note: The effectiveness of a countermeasure is expressed as a function of the percentage reduction in collisions and other violations over some previous treatment. Costs are expressed in U.S. dollars (approximate year 2000 amounts).¹

Source: Guidance on Traffic Control Devices at Highway-Rail Grade Crossings. Washington, DC: Federal Highway Administration, Highway/Rail Grade Crossing Technical Working Group, November 2002.

¹ "A Human Factors Analysis of Highway-Railway Grade Crossing Accidents In Canada." Transportation Development Centre, Transport Canada, September 2002 (www.tc.gc.ca/tde/summary/14000/14003.htm).

consumption losses of individuals and society at large caused by losses in production and the inability to produce. Many states have developed their own values, which reflect their situation and philosophy. Whichever is selected, the values ought to be consistent with those used for other safety improvement programs.

An appropriate interest rate is needed for most of the procedures considered. The selection of an inappropriate interest rate could result in unsuitable project costs and benefits and, thus, selection of an ineffective solution. Periods of rapid inflation and fluctuation of interest rates make the identification of an appropriate rate somewhat difficult. The standard rates used by the highway department should be selected.

The *Highway Safety Improvement Program User's Manual* states that the service life of an improvement should be equal to the time period that the improvement can reasonably affect collision rates. Both costs and benefits should be calculated for this time period. Hence, the service life is not necessarily the physical life of the improvement. For highway-rail grade crossings, however, it is a reasonable assumption that the improvement would be equally effective over its entire physical life. Thus, selecting the service life equal to the physical life would be appropriate. In particular, service life of signal equipment is fairly long because signals are visited by a maintainer at least once per month.

The selected service life can have a profound effect on the economic evaluation of improvement alternatives; therefore, it should be selected using the best available information.

Project costs should include initial capital costs and maintenance costs and should be considered life-cycle costs; in other words, all costs are distributed over the service life of the improvement. The installation cost elements include the following:

- Preliminary engineering.
- Labor.
- Material.
- Lease or rental of equipment.
- Miscellaneous costs.

The maintenance costs are all costs associated with keeping the system and components in operating condition. Maintenance costs are discussed in Chapter VII.

The salvage value may be an issue when a highway is upgraded or relocated, a railroad line is abandoned, etc. Salvage value is defined as the dollar value of a

project at the end of its service life and, therefore, is dependent on the service life of the project. For crossing signal improvement projects, salvage values are generally very small. Due to the characteristics of crossing signals and control equipment as well as the liability concerns that arise from deploying “second-hand” signals, it is assumed that there is zero salvage value after 10 years.

There are several accepted economic analysis methods, all of which require different inputs, assumptions, calculations, and methods and may yield different results. Several appropriate methods are described here.

1. Cost-Effectiveness Analysis

The cost-effectiveness analysis method is an adaptation of a traditional safety analysis procedure based on the calculation of the cost to achieve a given unit of effect (reduction in collisions). The significant aspects of this procedure are that it need not require the assignment of a dollar value to human injuries or fatalities and requires minimal manpower to apply.

The following steps should be performed for the cost-effectiveness technique:

1. Determine the initial capital cost of equipment, such as flashing lights or gates, and other costs associated with project implementation.
2. Determine the annual operating and maintenance costs for the project.
3. Select units of effectiveness to be used in the analysis. The desired units of effectiveness may be:
 - Number of total collisions prevented.
 - Number of collisions by type prevented.
 - Number of fatalities or fatal collisions prevented.
 - Number of personal injuries or personal injury collisions prevented.
 - Number of equivalent property-damage-only collisions prevented.
4. Determine the annual benefit for the project in the selected units of effectiveness, such as total number of collisions prevented.
5. Estimate the service life.
6. Estimate the net salvage value.
7. Assume an interest rate.
8. Calculate the equivalent uniform annual costs (EUAC) or present worth of costs (PWOC).
9. Calculate the average annual benefit, B, in the desired units of effectiveness.

10. Calculate the cost-effectiveness (C/E) value using one of the following equations:

$$C/E = EUAC / B, \text{ or}$$

$$C/E = PWOC(CRF_n^i) / B \tag{12}$$

where:

CRF_n^i = capital recovery factor for n years at interest rate i

Figure 57 shows a sample worksheet with fictitious values.

This is an iterative process for each alternative improvement. The results for all projects then can be arrayed and compared for selection. A computer program can be used for the analysis and ranking of projects.

2. Benefit-Cost Ratio

The benefit-cost ratio (B/C) is the collision savings in dollars divided by cost of the improvement. Using this method, costs and benefits may be expressed as either an equivalent annual or present worth value of the project. The B/C technique requires the following steps:

- Determine the initial cost of implementation of the crossing improvement being studied.
- Determine the net annual operating and maintenance costs.
- Determine the annual safety benefits derived from the project.
- Assign a dollar value to each safety benefit unit (NSC, NHTSA, or other).
- Estimate the service life of the project based on patterns of historic depreciation of similar types of projects.
- Estimate the salvage value of the project or improvement after its primary service life has ended.
- Determine the interest rate by taking into account the time value of money.
- Calculate the B/C ratio using EUAC and equivalent uniform annual benefits (EUAB).
- Calculate the B/C ratio using PWOC and present worth of benefits (PWOB).

A sample worksheet with fictitious values for the B/C analysis is shown in Figure 58.

This method requires an estimate of collision severity in dollar terms, which can greatly affect the outcome. It is relatively easy to apply and is generally accepted in engineering and financial studies. As with the C/E

method, the process can be performed for alternative improvements at a single crossing and arrayed for all projects to determine priorities for funding.

3. Net Annual Benefit

This method is based on the premise that the relative merit of an improvement is measured by its net annual benefit. This method is used to select improvements that will ensure maximum total benefits at each location. The net annual benefit of an improvement is defined as follows:

$$\text{Net annual benefit} = (EUAB) - (EUAC) \tag{13}$$

where:

EUAB = equivalent uniform annual benefit
 EUAC = equivalent uniform annual cost

A positive value for net annual benefit indicates a feasible improvement, and the improvement or set of improvements with the largest positive net annual benefit is considered the best alternative. The following steps should be used to compute the net annual benefit:

- Estimate the initial cost, annual cost, terminal value, and service life of each improvement.
- Estimate the benefits (in dollars) for each improvement.
- Select an interest rate.
- Compute EUAB.
- Compute EUAC.
- Calculate the net annual benefit of each improvement.

For the data and calculations shown in Figure 58, the net annual benefit would be \$91,438, determined from EUAB of \$104,000 less EUAC of \$12,562.

Although any of the three methods is an acceptable procedure to follow for economic analyses, they might produce different results depending on the values. Table 45 illustrates this point. The values shown for the second alternative are from the example provided above. Based on the C/E method, the analyst would select the third alternative. Based on the B/C ratio method, the analyst would select the second alternative. The first alternative would be selected if the net benefit method was followed for this example.

Figure 57. Sample Cost-Effectiveness Analysis Worksheet

Evaluation No.: _____ Project No.: _____ Date: _____
 Evaluator: _____

1. Initial implementation cost, I: \$ 100,000
2. Annual operating and maintenance costs before project implementation: \$ 100
3. Annual operating and maintenance costs after project implementation: \$ 1,000
4. Net annual operating and maintenance costs, $K = \#3 - \#2$: \$ 900
5. Annual safety benefits in number of injury accidents prevented, B, from below: 2

Accident Type	Actual	-	Expected	=	Annual Benefit
<u>Injury</u>	<u>4</u>	-	<u>2</u>	=	<u>2</u>
<u>Total</u>					

6. Service life, n: 20 years
8. Interest rate: 10% = 0.10
7. Salvage value, T: \$ 5,000 (Annual compounding interest)

9. EUAC Calculation:
 Capital recovery factor, CR = 0.1175
 Sinking fund factor, SF = 0.0175

$$\text{EUAC} = I(\text{CR}) + K - T(\text{SF})$$

$$= 100,000(0.1175) + 900 - 5,000(0.0175) = 12,562$$

10. Annual benefit: B (from #5) = 2 injury accidents

11. $C/E = \text{EUAC}/B = 12,562 / 2 = \$6,281 / \text{injury accidents prevented}$

12. PWOC Calculation:
 Present worth factor, PW = 8.5136
 Single payment present worth factor, SPW = 0.1486

$$\text{PWOC} = I + K(\text{PW}) - T(\text{SPW})$$

$$= 100,000 + 900(8.5136) - 5,000(0.1486) = 106,919$$

13. Annual benefit
 n (from #6) = 20 years
 B (from #5) = 2 accidents prevented per year

14. $C/E = \text{PWOC}(\text{CR})/B$
 $= (106,919)(0.1175) / 2 = \$6,281 / \text{injury accidents prevented}$

Source: Railroad-Highway Grade Crossing Handbook, Second Edition. Washington, DC: U.S. Department of Transportation, Federal Highway Administration, 1986.

Figure 58. Sample Benefit-to-Cost Analysis Worksheet

Evaluation No.: _____ Project No.: _____ Date: _____
 Evaluator: _____

- 1. Initial implementation cost, I: \$ 100,000
- 2. Annual operating and maintenance costs before project implementation: \$ 100
- 3. Annual operating and maintenance costs after project implementation: \$ 1,000
- 4. Net annual operating and maintenance costs, K (#3 - #2): \$ 900

5. Annual safety benefits in number of accidents prevented:

Severity	Actual	-	Expected	=	Annual Benefit
a) Fatal accidents (fatalities)	<u>0</u>	-	<u>0</u>	=	<u>0</u>
b) Injury accidents (injuries)	<u>4</u>	-	<u>2</u>	=	<u>2</u>
c) PDO accidents (involvements)	<u>5</u>	-	<u>3</u>	=	<u>2</u>

6. Accident cost values (Source Department)

Severity	Cost
a) Fatal accident (fatality)	\$ <u>500,000</u>
b) Injury accident (injury)	\$ <u>50,000</u>
c) PDO accident (involvement)	\$ <u>2,000</u>

7. Annual safety benefits in dollars saved, B:
- (5a) x (6a) = 500,000 x 0 = 0
 - (5b) x (6b) = 50,000 x 2 = 100,000
 - (5c) x (6c) = 2,000 x 2 = 4,000
 - Total = \$104,000

- 8. Service life, n: 20 yrs
- 10. Interest rate: 10% = .10
- 9. Salvage value, T: \$5,000 (Annual compounding interest)

11. EUAC Calculation:
- Capital recovery factor, CR = 0.1175
 Sinking fund factor, SF = 0.0175
 EUAC = I (CR) + K - T (SF)
 = 100,000 (0.1175) + 900 - 5,000 (0.0175) = 12,562
12. EUAB Calculation: EUAB = B = 104,000
13. B/C = EUAB/EUAC = 104,000 / 12,562 = 8.3
14. PWOC Calculation:
- Present worth factor, PW = 8.5136
 Single payment present worth factor, SPW = 0.1486
 PWOC = I + K (SPW) - T (PW)
 = 100,000 + 900 (8.5136) - 5,000 (0.1486) = 106,919
15. PWOB Calculation:
 PWOB = B (SPW) = 104,000 (8.5136) = 885,414
16. B/C = PWOB/PWOC = 885,414 / 106,919 = 8.3

Source: Railroad-Highway Grade Crossing Handbook, Second Edition. Washington, DC: U.S. Department of Transportation, Federal Highway Administration, 1986.

Given that different results can occur, the agency should not follow just one procedure. At least two methods should be followed, with the decision based on these results and other factors, constraints, and policies of the agency.

Table 45. Comparison of Cost-Effectiveness, Benefit-Cost, and Net Benefit Methods

	Initial Costs	Cost-Effectiveness (\$/acc.)	B/C	Net Benefit
A	1,000,000	106,000	2	200,000
B	100,000	6,281	8.3	91,438
C	20,000	5,100	5	70,000

Source: Railroad-Highway Grade Crossing Handbook, Second Edition. Washington, DC: U.S. Department of Transportation, Federal Highway Administration, 1986.

E. Resource Allocation Procedure

In lieu of the economic analysis procedures described above, U.S. DOT has developed a resource allocation procedure for highway-rail grade crossing improvements. This procedure was developed to assist states and railroads in determining the effective allocation of federal funds for crossing traffic control improvements.

The resource allocation model is designed to provide an initial list of crossing traffic control improvements that would result in the greatest collision reduction benefits on the basis of cost-effectiveness considerations for a given budget. As designed, the results are checked by a diagnostic team in the field and revised as necessary. It should be noted that the procedure considers only traffic control improvement alternatives as described below:

- For passive crossings, single track, two upgrade options exist: flashing lights or gates.
- For passive, multiple-track crossings, the model allows only the gate option to be considered in accordance with the Federal-Aid Policy Guide.
- For flashing light crossings, the only improvement option is gates.

Other improvement alternatives, such as removal of site obstructions, crossing surface improvements, illumination, and train detection circuitry

improvements, are not considered in the resource allocation procedure.

The input data required for the procedure consist of the number of predicted collisions, the safety effectiveness of flashing lights and automatic gates, improvement costs, and the amount of available funding.

The number of annual predicted collisions can be derived from the U.S. DOT Accident Prediction Model or from any model that yields the number of annual collisions per crossing. (See discussion in Chapter III.)

Safety effectiveness studies for the equipment used in the resource allocation procedure have been completed by U.S. DOT, the California Public Utilities Commission, and William J. Hedley. The resulting effectiveness factors of these studies were given in Table 40 for the types of signal improvements applicable for the procedure. Effectiveness factors are the percent reduction in collisions occurring after the implementation of the improvement.

The model requires data on the costs of the improvement alternatives. Life-cycle costs of the devices should be used, such as both installation and maintenance costs.

Costs used in the resource allocation procedure must be developed for each of the three alternatives:

- Passive devices to flashing lights.
- Passive devices to automatic gates.
- Flashing lights to gates.

Caution should be exercised in developing specific costs for a few selected projects while assigning average costs to all other projects. If this is done, decisions regarding the adjusted crossings may be unreasonably biased by the algorithm.

The amount of funds available for implementing crossing signal projects is the fourth input for the resource allocation procedure.

The resource allocation procedure is shown in Figure 59. It employs a step-by-step method, using the inputs described above.

For any proposed signal improvement, a pair of parameters, E_j and C_j , must be provided for the resource allocation algorithm. As shown in Table 46, $j = 1$ for flashing lights installed at a passive crossing; $j = 2$ for gates installed at a passive crossing; and $j = 3$ for gates installed at a crossing with flashing lights. The first parameter, E_j , is the effectiveness of installing

Figure 59. Crossing Resource Allocation Procedure

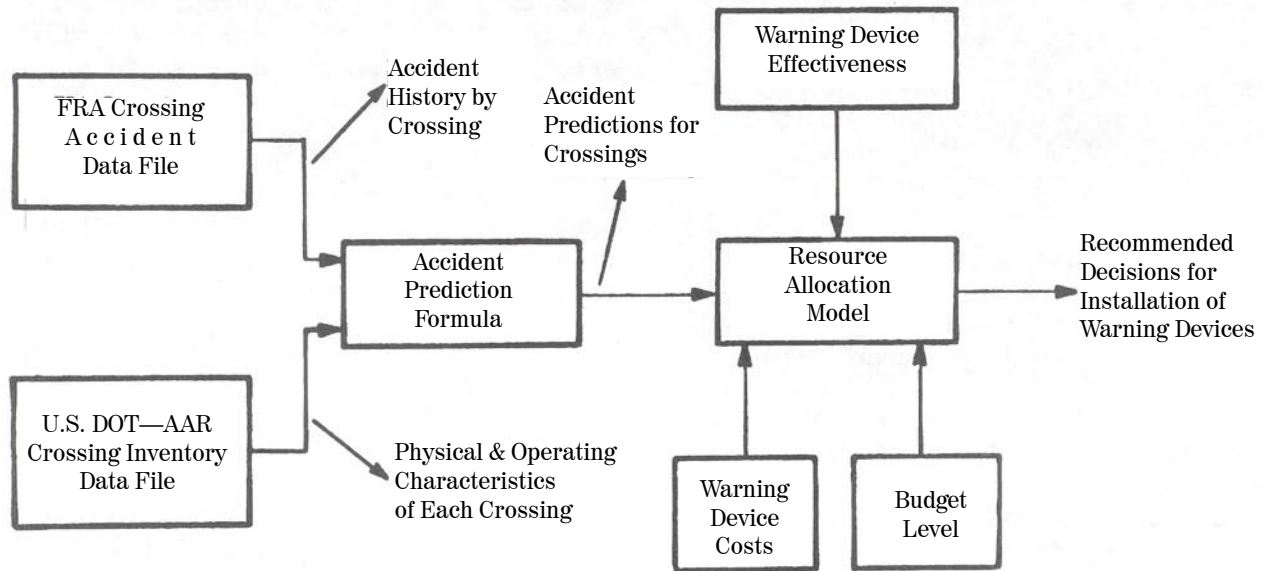

Source: Railroad-Highway Grade Crossing Handbook, Second Edition. Washington, DC: U.S. Department of Transportation, Federal Highway Administration, 1986.

a proposed warning device at a crossing with a lower class warning device. The second parameter, C_j , is the corresponding cost of the proposed warning device.

Table 46. Effectiveness/Cost Symbol Matrix

Proposed warning device	Existing warning device	
	Passive	Flashing lights
Flashing lights		
Effectiveness	E_1	—
Cost	C_1	—
Automatic gates		
Effectiveness	E_2	E_3
Cost	C_2	C_3

Source: Railroad-Highway Grade Crossing Handbook, Second Edition. Washington, DC: U.S. Department of Transportation, Federal Highway Administration, 1986.

The resource allocation procedure considers all crossings with either passive or flashing light traffic control devices for signal improvements. If, for example, a single-track passive crossing, i , is considered, it could be upgraded with either flashing lights, with an effectiveness of E_1 , or gates, with an

effectiveness of E_2 . The number of predicted collisions at crossing i is A_i . Therefore, the reduced accidents per year is $A_i E_1$ for the flashing light option and $A_i E_2$ for the gate option. The corresponding costs for these two improvements are C_1 and C_2 . The accident reduction/cost ratios for these improvements are $A_i E_1 / C_1$ for flashing lights and $A_i E_2 / C_2$ for gates. The rate of increase in accident reduction versus costs that results from changing an initial decision to install flashing lights with a decision to install gates at crossing i is referred to as the incremental accident reduction/cost ratio and is equal to:

$$A_i (E_2 - E_1) / (C_2 - C_1) \tag{14}$$

If a passive multiple-track crossing, i , is considered, the only improvement option allowable would be installation of gates, with an effectiveness of E_2 , a cost of C_2 , and an accident reduction/cost ratio of $A_i E_2 / C_2$. If crossing i was originally a flashing light crossing, the only improvement option available would be installation of gates, with an effectiveness of E_3 , a cost of C_3 , and an accident reduction/cost ratio of $A_i E_3 / C_3$.

The individual accident reduction/cost ratios associated with these improvements are selected by the algorithm in an efficient manner to produce the maximum accident reduction that can be obtained for a predetermined total cost. This total cost is the sum of

an integral number of equipment costs (C_1 , C_2 , and C). The total maximum accident reduction is the sum of the individual accident reductions of the form $A_i E_j$.

The resource allocation procedure is being updated to include the severity prediction equations discussed in Chapter III.

The U.S. DOT Rail-Highway Crossing Resource Allocation Procedure, as described in the *Rail-Highway Crossing Resource Allocation Procedure's Guide, Third Edition* (August 1987), uses three "normalizing constants" in the accident prediction formula, Formula A (Section 3.2.4, page 17). These constants need to be adjusted periodically to keep the procedure matched with current collision trends. The last recalculation and adjustment was made for calendar year 1998 and published in the Appendix for the *Railroad Safety Statistics Annual Report* starting for year 1999.

Using the collision data for calendar years 1997 to 2001 (to predict 2002), the process of determining the three new normalizing constants for 2003 was performed such that the sum of the 2002 accident prediction values of all currently open public at-grade crossings is made to equal the sum of the *observed* number of collisions that occurred for those same crossings. This process is performed for each of the respective three formulae for the three types of warning device categories: passive, flashing lights, and gates. This process normalized the calculated prediction for the current trend in collision data (downward) for each category and relative to each of the three types of warning device categories (see Table 47).

As of November 2003, these new constants are in the 2003 PC Accident Prediction System (PCAPS) computer program and the Internet version, Web Accident

Prediction System (WBAPS), on the FRA Website.¹¹⁹ Table 47 lists the new and prior constants.

If this resource allocation procedure is used to identify high-hazard crossings, a field diagnostic team should investigate each selected crossing for accuracy of the input data and reasonableness of the recommended solution. A worksheet for accomplishing this is included in Figure 60. This worksheet also includes a method for manually evaluating or revising the results of the computer model.

F. Federal Railroad Administration GradeDec Software

FRA developed the GradeDec.NET (GradeDec) highway-rail grade crossing investment analysis tool to provide grade crossing investment decision support. GradeDec provides a full set of standard benefit-cost metrics for a rail corridor, a region, or an individual grade crossing. Model output allows a comparative analysis of grade crossing alternatives designed to mitigate highway-rail grade crossing collision risk and other components of user costs, including highway delay and queuing, air quality, and vehicle operating costs. The online application can be accessed via FRA's Website.¹²⁰

GradeDec is intended to assist state and local transportation planners in identifying the most efficient grade crossing investment strategies. The GradeDec modeling process can encourage public support for grade crossing strategies, including closure and separation, where project success often depends on getting the community involved in the early planning stages. GradeDec computes model output using a range of values for many of the model inputs. This process allows individual stakeholders to influence how different investment options are weighed and evaluated.

GradeDec implements the corridor approach to reducing collision risk that was developed as part of the Transportation Equity Act for the 21st Century's Next-Generation High-Speed Rail Program. This approach can be an effective means of reducing the overall capital costs involved in constructing facilities for high-speed passenger rail service (at speeds

Table 47. Collision Prediction and Resource Allocation Procedure Normalizing Constants

Warning device groups	New	Prior years				
	2003	1998	1992	1990	1988	1986
Passive	.6500	.7159	.8239	.9417	.8778	.8644
Flashing lights	.5001	.5292	.6935	.8345	.8013	.8887
Gates	.5725	.4921	.6714	.8901	.8911	.8131

Source: Federal Railroad Administration Website (safetydata.ra.dot.gov/officeofsafety).

119 Federal Railroad Administration (FRA) Website (safetydata.fra.dot.gov/officeofsafety).

120 FRA Website (gradedec.fra.dot.gov).

Figure 60. Resource Allocation Procedure Field Verification Worksheet

This worksheet provides a format and instructions for use in field evaluation of crossing to determine if initial recommendations for warning device installations from the Resource Allocation Procedure should be revised. Steps 1 through 5, described below, should be followed in making the determination. In Steps 1 and 3, the initial information (left column) is obtained from office inventory data prior to the field inspection. In Step 4, the decision criteria values are obtained from the Resource Allocation Model printout.

STEP 1: Validate Data used in Calculating Predicted Accidents:

<u>Crossing Characteristic</u>	<u>Initial Information</u>	<u>Revised Information</u>
Crossing Number		
Location		
Existing Warning Device		
Total Trains per Day		
Annual Average Daily Highway Traffic (c)		
Day thru Trains (d)		
Number of Main Tracks (mt)		
Is Highway Paved? (hp)		
Maximum Timetable Speed, mph (ms)		
Highway Type (ht)		
Number of Highway Lanes (hl)		
Number of Years of Accident History (T)		
Number of Accidents in T Years (N)		
Predicted Accident Rate (A)		

STEP 2: Calculate Revised Accident Prediction from DOT Formula if any Data in Step 1 has been Revised.

Revised Predicted Accidents (A) = _____

STEP 3: Validate Cost and Effectiveness Data for Recommended Warning Device

Assumed Effectiveness of Recommended Warning Device (E) _____ Assumed

Cost of Recommended Warning Device (C)
Recommended Warning Device Installation

STEP 4: Determine if Recommended Warning Device should be Revised if A, E, or C has Changed.

1. Obtain Decision Criteria Values from Resource Allocation Model. Output:

$$DC_1 = \text{___} \quad DC_2 = \text{___} \quad DC_3 = \text{___} \quad DC_4 = \text{___}$$

2. Calculate: $R = \frac{\text{Revised A}}{\text{Previous A}} \diamond \frac{\text{Revised B}}{\text{Previous B}} \diamond \frac{\text{Revised C}}{\text{Previous C}}$

3. Compare R with Appropriate Decision Criteria as shown Below:

Existing Passive Crossing (Classes 1, 2, 3, 4) Single Track		Existing Passive Crossing (Classes 1, 2, 3, 4) Multiple Tracks		Existing Flashing Light. Crossing (Classes 5, 6, 7)	
<u>Comparison</u>	<u>Decision</u>	<u>Comparison</u>	<u>Decision</u>	<u>Comparison</u>	<u>Decision</u>
$DC_2 < R$	Gates	$DC_3 < R$	Gates	$DC_4 < R$	Gates
$DC_3 < R < DC_2$	Flashing Lights	$R < DC_3$	No Installation	$R < DC_4$	No Installation
$R < DC_1$	No Installation				

4. Revised Recommended Warning Device Installation* _____

STEP 5: Determine other Characteristics that may Influence Warning Device Installation Decisions

Multiple tracks where one train/locomotive may obscure vision of another train?	Either, or any combination of, high vehicular traffic volumes, high numbers of train movements, substantial numbers of school buses or trucks carrying hazardous materials, unusually restricted sight.
Percent trucks	
Passenger train operations over crossing	
High speed trains with limited sight distance**	distance or continuing accident occurrences**
Combination of high speeds & moderately high volumes of highway & railroad traffic **	

*The cost and effectiveness values for the revised warning device are assumed to change by an amount proportional to the change in these values for the initial recommended warning device as determined in Step 3.

**Gates with flashing lights are the only recommended warning device per 23CFR 646.214(b)(3)(i).

Source: Railroad-Highway Grade Crossing Handbook, Second Edition. Washington, DC: U.S. Department of Transportation, Federal Highway Administration, 1986.

between 111 and 125 mph), where grade crossing hazards and mitigation measures can be a major cost factor.

The corridor approach can be used to demonstrate that acceptable levels of collision risk have been reached for all rail corridors, train types, and speeds. For example, exceptions to the proposed federal rule mandating whistle-sounding at all highway-rail grade crossings can be made by showing that appropriate safety measures have been taken to mitigate the additional risk otherwise presented by trains not sounding their horns.

GradeDec uses simulation methods to analyze project risk and generate probability ranges for each model output, including B/C ratios and net present value. The software also analyzes the sensitivity of project risk to GradeDec 2000 model inputs to inform users which factors have the greatest impact on project risk.¹²¹

¹²¹ FRA GradeDec 2000 program for evaluating costs/benefits of railroad-highway grade crossing investments (www.fra.dot.gov/us/content/1195).

G. References

The Effectiveness of Automatic Protection in Reducing Accident Frequency and Severity at Public Grade Crossings in California. San Francisco, California: California Public Utilities Commission, June 1974.

Guidance on Traffic Control Devices At Highway-Rail Grade Crossings. Washington, DC: FHWA, Highway/Rail Grade Crossing Technical Working Group, 2002.

Highway Safety Improvement Program User's Manual. Washington, DC: Federal Highway Administration (FHWA).

Hitz, John and Mary Cross. *Rail-Highway Crossing Resource Allocation Procedure User's Guide.* Washington, DC: FHWA and Federal Railroad Administration (FRA), Report FHWA-IP-82-7, December 1982.

Morrissey, J. *The Effectiveness of Flashing Lights and Flashing Lights with Gates in Reducing Accident Frequency at Public Rail-Highway Crossings, 1975-1978.* Washington, DC: FRA and FHWA, April 1980.

Implementation of Projects

VI

An organized approach to the implementation of a highway-rail grade crossing improvement program is necessary so that its administrators will proceed effectively and expeditiously to obtain the benefits of the program. The implementation component consists of obtaining all necessary regulatory and funding approvals; preparing and executing agreements among participating parties (typically federal, state, railroad, and any local authorities); designing the selected alternative in detail; establishing appropriate accounting procedures (generally as set forth in the agreements); and constructing the project.

A. Funding

Sources of funds for highway-rail grade crossing improvements include federal, state, and local government agencies, the railroad industry, and special funding.

1. Federal Sources

The Safe, Accountable, Flexible, Efficient Transportation Equity Act: A Legacy for Users (SAFETEA-LU), enacted in 2005, made a number of significant changes in the available matching ratios and the funding environment for highway-rail grade crossing projects. SAFETEA-LU continued the appropriation of federal-aid highway funds through fiscal year 2009. The designation of a safety set-aside in Surface Transportation Program (STP) funding for each state for categorical safety programs, including the highway-rail grade crossing program, which began in 1973, was shifted to the new Highway Safety Improvement Program (HSIP) starting in 2006. From 2006 through 2009, \$220 million has been authorized each year in SAFETEA-LU under HSIP as a set-aside for the Section 130 program to reduce the number of fatalities and injuries at public railway-highway crossings through the elimination of hazards and/or the

installation/upgrade of protective devices at crossings (SAFETEA-LU Section 1401).

SAFETEA-LU also continued the Federal-Aid Bridge Rehabilitation and Replacement Program, allocating \$21.6 billion for bridges, including bridges carrying highways over railroads, over the life of the act.

The major provisions of SAFETEA-LU are as follows:

- SAFETEA-LU continues the ability to provide funding for the elimination of hazards at railway-highway crossings on any public road. Section 1401 creates the new HSIP. This new core program redefines the federal-aid safety program by combining and expanding the definitions of safety projects previously contained in 23 USC 130 and 152. The new program is defined in 23 USC 148 and specifically defines eligible railway-highway crossing projects as:
 - Construction of any project for the elimination of hazards at a railway-highway crossing that is eligible for funding under Section 130, including the separation or protection of grades at railway-highway crossings [23 CFR 148(a)(3)(b)(vi)].
 - Construction of a railway-highway crossing safety feature, including installation of protective devices [23 CFR 148(a)(3)(b)(vii)].
 - The conduct of a model traffic enforcement activity at a railway-highway crossing [23 CFR 148(a)(3)(b)(viii)].
- The set-aside Section 130 funds under HSIP may be used for but are not limited to the following types of railroad grade crossing safety improvement projects:

- Crossing elimination by new grade separations, relocation of highways, relocation of roadways, relocation of railroads, and crossing closure without other construction.
- Reconstruction of existing grade separations.
- Crossing improvement by:
 - Installation of standard signs and pavement markings.
 - Installation of STOP signs.
 - Installation or replacement of active traffic control devices, including track circuit improvements and interconnection with highway intersection traffic signals.
 - Crossing illumination.
 - Crossing surface improvements.
 - General site improvements.
- Matching ratios: For projects completed with HSIP funds, the federal matching ratios will be 90 percent or 100 percent, depending on the type of work being accomplished. States, railroads, or localities fund or share the funding of the 10-percent match, where required. Section 130(f) of the Highway Safety Act of 1973 provided a mechanism for increasing the federal share where both local and state funds were incorporated into a railroad project; however, this was usually impractical in practice. SAFETEA-LU continues the provisions of Section 1021(c) of the Intermodal Surface Transportation Efficiency Act, which permits an increased federal share on certain types of safety projects, including traffic control signalization, pavement marking, commuter carpooling and vanpooling, or installation of traffic signs, traffic lights, guardrails, impact attenuators, concrete barrier end treatments, breakaway utility poles, or priority control systems for emergency vehicles at signalized intersections. The Federal Highway Administration (FHWA) has determined that railroad grade crossing signals are included in traffic control signalization.¹²² SAFETEA-LU continues this eligibility for these projects.
- SAFETEA-LU continues the requirement that a state spend a minimum of 50 percent of its apportionment for the installation of protective devices at railway-highway crossings. The

remaining funds may be spent for other types of improvements as defined in Section 130. SAFETEA-LU also contains a provision that up to 2 percent of the funds apportioned to a state may be used for compilation and analysis of data for the required annual report to the secretary on the progress being made to implement the railway-highway crossings program.

- Additional relevant provisions: SAFETEA-LU continues the ability to make incentive payments in exchange for railway-highway crossing closures. This provision was included in Section 353 of the fiscal year 1997 U.S. Department of Transportation (U.S. DOT) Appropriations Bill. This payment cannot exceed \$7,500 per crossing closure as an equal match to incentives offered by a railroad and does not require a match (i.e. 100-percent funding). A local government receiving an incentive payment from a state shall use the amount of the incentive payment for transportation safety improvements. These improvements are those defined by SAFETEA-LU Section 1401 [revised 23 USC 148(a)(3)] and 23 USC 402.

SAFETEA-LU continues the funding for the 23 USC Section 144 Bridge Replacement and Rehabilitation Program. All bridges carrying highway traffic on public roads, regardless of ownership or maintenance responsibility, are eligible for improvement or replacement under this program. This includes bridges owned by railroads. The federal share in this program is 80 percent. To be eligible for these funds, the bridge over the railroad must be included in the state's bridge inventory and must be placed on the state's prioritized implementation schedule.

In addition to the specific programs described above, other regular federal-aid highway funds may be used for improvements at crossings. The federal share is the normal matching share for the federal-aid highway funds and the types of work involved.

Other requirements pertaining to the use of federal funds are as follows:

- Federal funds are not eligible for costs incurred solely for the benefit of the railroad.
- At grade separations, federal funds are eligible to participate in costs to provide space for more tracks than are in place when the railroad establishes to the satisfaction of the state highway

¹²² Intermodal Surface Transportation Efficiency Act of 1991, Public Law 102-240.

agency and FHWA that it has a definite demand and plans for the installation of the additional tracks within a reasonable time.

- States cannot require railroads to participate in the cost of certain crossing improvement projects completed with federal funds. These projects are specified in the Federal-Aid Policy Guide (FAPG) and referenced to 23 CFR §646.210.¹²³ Restrictions include:
 - o State laws that require railroads to share in the cost of work for the elimination of hazards at highway-rail grade crossings are not applicable on federal-aid projects.
 - o Projects for grade crossing improvements are deemed to be of no net benefit to the railroad, and there shall be no required railroad share of the costs.
 - o Projects for the reconstruction of existing grade separations are deemed to generally be of no ascertainable net benefit to the railroad, and there shall be no required railroad share of the costs, unless the railroad has a specific contractual obligation with the state or its political subdivision to share the costs.
- The federal share of the cost of a grade separation shall be based on the cost to provide horizontal and/or vertical clearances used by the railroad in its normal practice, subject to limitations as shown in the Appendix to FAPG or as required by a state regulatory agency.¹²⁴
- The railroad share of federal-aid projects that eliminate an existing crossing at which active control devices are in place or ordered to be installed by a state regulatory agency is to be 5 percent. These costs are to include costs for preliminary engineering, right of way, and construction as specified below and in 23 CFR §646.210:
 - o Where a grade crossing is eliminated by grade separation, the structure and approaches required to transition to a theoretical highway profile that would have been constructed if there were no railroad present, for the number of lanes on the existing highway and in accordance with the current design standards of the state highway agency.

- o Where another facility requiring a bridge structure, such as a highway or waterway, is located within the limits of a grade-separation project, the estimated cost of a theoretical structure and approaches to eliminate the highway-rail grade crossing without considering the presence of the waterway or other highway.
- o Where a grade crossing is eliminated by railroad or highway relocation, the actual cost of the relocation project, the estimated cost of the relocation project, or the estimated cost for a structure and approaches as described above, whichever is less.
- o Railroads may voluntarily contribute a greater share of project costs. Also, other parties may voluntarily assume the railroad's share.

There were a number of federally-funded demonstration projects. These projects were site-specific and are dependent upon annual authorization and appropriations by Congress.

2. State Funding

States also participate in the funding of highway-rail grade crossing improvement projects. States often contribute the matching share for projects financed under the federal-aid highway program. In addition, states sometimes finance entire crossing projects, particularly if the crossing is on a state highway.

In general, for crossings on the state highway system, states provide for the maintenance of the highway approach and for traffic control devices not located on the railroad right of way. Typically, these include advance warning signs and pavement markings.

3. Local Agency Funding

A number of cities and counties have established highway-rail grade crossing improvement funds. Some of these programs provide funding for partial reimbursement of railroad maintenance costs at crossings; some have been established to meet the matching requirements of state and federal programs. Local agencies are often sources of funding for low-cost improvements such as removing vegetation and providing illumination. In addition, local agencies are responsible for maintaining the roadway approaches and the traffic control devices off the railroad right of way on highways under their maintenance jurisdiction.

¹²³ *Federal-Aid Policy Guide*. Washington, DC: Federal Highway Administration (FHWA), updated periodically.

¹²⁴ *Ibid*.

4. Railroad Funding

Except in certain instances, railroads cannot be required to contribute to the costs of most improvement projects financed with federal funds. However, railroads often volunteer to participate if they receive some benefit from the project. For example, if a project includes the closure of one or more crossings, the railroad may benefit from reduced maintenance costs. Railroads also may assist in low-cost improvements such as changes in railroad operations, track improvements, right-of-way clearance, and others. The maintenance costs incurred by railroads are increased significantly with the installation of additional active traffic control devices. These costs are discussed in Chapter VII.

B. Agreements*

A highway-rail grade crossing project involves a minimum of two parties: the state and the railroad. If the crossing is not on the state highway system, an agreement with the county or municipality having maintenance and enforcement jurisdiction over the road will usually be required. The agreement between the state agency and the railroad will establish the project location, scope of work, standards to be applied, basis of payment, and billing procedures. The agreement between the state and the local jurisdiction will provide the authority for the state and the railroad to work and control traffic on the local facility; provide the amount and basis of payment for any local share; establish the maintenance responsibility for the improvements; and should provide for the passage of a law or ordinance so that any traffic control devices being installed at the crossing can be implemented and enforced.

Current practice is to define project responsibilities of the highway authority and the railroad in construction and management (C&M) agreements developed prior to initiation of final design and construction of improvements. C&M agreements can include provisions regarding right of entry and railroad flagging.

FAPG and 23 CFR §646.216(d) require that the written agreement between the state and the railroad shall include the following, as applicable:¹²⁵

- The provisions of this subpart and of 23 CFR §140, Subpart I, incorporated by reference.
- A detailed statement of the work to be performed by each party.

* Includes previously unpublished materials provided by Ray Lewis, West Virginia Department of Transportation (WVDOT), 2006.

¹²⁵ *Federal-Aid Policy Guide*. Washington, DC: FHWA, updated periodically.

- Method of payment (either actual cost or lump sum).
- For projects that are not for the elimination of hazards of highway-rail crossings, the extent to which the railroad is required to move or adjust its facilities at its own expense.
- The railroad's share of the project cost.
- An itemized estimate of the cost of the work to be performed by the railroad.
- Method to be used for performing the work, either by railroad forces or by contract.
- Maintenance responsibility.
- Form, duration, and amounts of any needed insurance.
- Appropriate reference to or identification of plans and specifications.
- Statements defining the conditions under which the railroad will provide or require protective services during performance of the work, the type of protective services, and the method of reimbursement to the railroad.
- Provisions regarding inspection of any recovered materials.

Much of the language that must be included in agreements between state highway agencies and railroads is identical from project to project and location to location. A "master agreement" can be used to facilitate the progress of projects. A true master agreement can save valuable programming, legal review, and negotiation time.¹²⁶ With a master agreement, individual projects can be accomplished through the execution of a change order or supplemental letter agreement specific to the individual project or location. Depending on the individual state and railroad, master agreements may be executed to cover all projects or may be executed separately to cover only specific types of work, such as signals and surface improvements.

The master agreement sets forth the purpose of the agency to engage in the construction or reconstruction of some part or parts of its highway system, which calls for the installation or adjustment of traffic control systems or some other aspect of crossings. The master agreement requires the railroad to prepare detailed plans and specifications for the work to be performed and establishes responsibility for the procurement of materials for improvements. It contains the other provisions pertaining to the general requirements contained in contractual agreements. Change orders or letter agreements in a specified format are then issued for individual projects.

¹²⁶ Hargrove, Lamar H.P. "New Approaches to System Management." Proceedings of the 1974 National Conference on Railroad-Highway Crossing Safety, panel presentation, August 19–22, 1974.

For federal-aid projects, a simplified procedure can be found in FAPG Section 646.218.¹²⁷ This procedure defines eligible preliminary engineering costs as those incurred in selecting crossings to be improved, determining the type of improvement for each crossing, estimating costs, and preparing the required agreement. The agreement must contain the identification of each crossing location, a description of the improvements, an estimate of costs by crossing location, and an estimated schedule for the completion of work. Following programming, authorization, and approval of the agreement, FHWA may authorize construction, including the acquisition of materials, with the condition that work will not be undertaken until the agreement is found satisfactory by FHWA and the final plans, specifications, and estimates are approved. Only material actually incorporated into the project will be eligible for federal participation.

C. Accounting*

To be eligible for reimbursement, the costs incurred in work performed on highway-rail grade crossing improvement projects must be tracked in accordance with strict accounting practices and procedures. In that federal-aid highway funds are the primary revenue source for crossing safety improvements, accounting principles adopted by FHWA have become the guide for most state and all federal crossing programs. There are several reasons for the similarities between state and federal accounting procedures. First, as mentioned previously, federal-aid highway funds represent a major part of total state expenditures for crossing improvements. Second, a large part of the state funds expended is in the form of matching funds. Third, because states reach agreement with railroads and local communities for the implementation of crossing projects under both federal and state-funded programs, the accounting procedure for the two programs requires compatibility.

The basic accounting principle to be followed is that all parties to a highway-rail grade crossing improvement must have established a cost accounting system that is capable of segregating all labor, materials, equipment rentals, and other costs associated with the engineering, right-of-way acquisition, utility relocations, or construction work being done under each project.

The policies and procedures of FHWA on reimbursement for railroad work can be found in FAPG

* Includes previously unpublished materials provided by Ray Lewis, WVDOT, 2006.

¹²⁷ *Federal-Aid Policy Guide*. Washington, DC: FHWA, updated periodically.

Subpart 140I.¹²⁸ To be eligible for reimbursement, the costs must be:

- For work included in an approved program.
- Incurred subsequent to the date of authorization by FHWA.
- Incurred in accordance with the provisions of 23 CFR, Part 646, Subpart B.
- Properly attributable to the project.

Following is a brief description of highway-rail grade crossing improvement costs generally considered eligible for reimbursement:

- Labor costs: Salaries and wages, including fringe benefits and employee expenses. Labor costs include labor associated with preliminary engineering, construction engineering, right of way, and force account construction. Fees paid to engineers, architects, and others for services are also reimbursable.
- Material and supply costs: The actual costs of materials including inspection, testing, and handling.
- Equipment costs: The actual expenses incurred in the operation of equipment. Costs incurred in equipment leasing and accrued equipment rental charges at established rates are also eligible for reimbursement.
- Transportation costs: The costs of employee transportation and the transportation cost for the movement of material, supplies, and equipment.
- Protective service costs: Expenses incurred in the provision of safety to railroad and highway operations during the construction process.

An agreement providing for a lump sum payment in lieu of a later determination of actual costs (an audit of the project) may be used for the installation of crossing traffic control devices and/or crossing surfaces, regardless of costs. If the lump sum method of reimbursement is used, periodic reviews and analyses of the railroad's methods and cost data used to develop lump sum estimates should be conducted.

Progress billings of incurred costs may be made according to the executed agreement between the state and the railroad. Costs for materials stockpiled at the project site or specifically purchased and delivered to the company for use on the project may also be reimbursed following approval of the agreement.

¹²⁸ *Federal-Aid Policy Guide*. Washington, DC: FHWA, updated periodically.

A major problem experienced in the accounting process is the timeliness of final billings. The railroad should provide one final and complete billing of all incurred costs, or of an agreed lump sum, at the earliest possible date. The final billing should include certification that the work is complete, acceptable, and in accordance with the terms of the agreement.

Salvage value of existing traffic control devices at crossings to be upgraded or closed is a concern. If the equipment is relatively new and in good condition, it may be desirable to reuse it at another crossing. However, if the equipment is older, the cost to remove and refurbish it may make reuse inefficient.

D. Design and Construction

The design of highway-rail grade crossing improvement projects is usually completed by state or railroad engineering forces or by an engineering consultant selected by the state or railroad with the same agency administering the contract. The designation of the designer is to be mutually agreed to by both the state and the railroad.

The railroad signal department usually prepares the design for the active traffic control system, including the train detection circuits. In addition, the railroad signal department usually prepares a detailed cost estimate of the work.

Adequate provision for needed easements, rights of way, temporary crossings for construction purposes, or other property interests should be included in the project design and covered in the agreement.

For federal-aid highway projects, it is expected that materials and supplies, if available, will be furnished from railroad company stock, except that they may be obtained from other sources near the project site when available at less cost. If the necessary materials and supplies are not available from company stock, they may be purchased either under competitive bids or existing continuing contracts, under which the lowest available prices are developed. Minor quantities and proprietary products are excluded from these requirements. The company should not be required to change its existing standards for materials used in permanent changes to its facilities.

Some states allow railroads to stockpile crossing signal materials so that projects may be completed as rapidly as possible. Provided the design of the crossing signals is based on the most appropriate equipment for the individual project, this practice is acceptable.

Scheduling of crossing projects should be accomplished to maximize the efficiency of railroad, state, local, and contractor work forces. This requires coordination and cooperation among all parties. In addition, construction at crossings should be scheduled to minimize the effects on the traveling public. Notice of planned construction activities should be sent to local newspapers and television and radio stations one to three months in advance. Final notices should be given one week and one day in advance of commencing construction work. Efforts should be made to avoid construction during peak hours of highway and train traffic.

When scheduling construction activities, consideration should be given to accomplishing work at crossings in the same geographical area at the same time. In this manner, the travel time of construction crews and the transportation costs of materials are minimized. This is one advantage of the systems approach because all crossings in a specified rail corridor, community, or area are improved at the same time.

For federal-aid highway projects, construction may be accomplished by:

- Railroad force account;
- Contracting with the lowest qualified bidder based on appropriate solicitations;
- Existing continuing contracts at reasonable costs; or
- Contract without competitive bidding, for minor work, at reasonable costs.

Reimbursement with federal-aid highway funds will not be made for any increased costs due to changes in plans for the convenience of the contractor nor for changes that have not been approved by the state and FHWA.

Contractors may be subject to liability with respect to bodily injury to or death of persons and injury to or destruction of property, which may be suffered by persons other than their own employees as a result of their operations in connection with the construction of highway projects located wholly or partly within railroad right of way and financed in whole or in part with federal funds. Under FAPG, protection to cover such liability of contractors is to be furnished under regular contractors' public liability and property insurance policies, issued in the names of the contractors. Such policies should be written to furnish protection to contractors respecting their operations in performing work covered by their contract.

If a contractor sublets a part of the work on any project to a subcontractor, the contractor should require insurance protection on his or her own behalf under the contractor's public liability and property damage insurance policies. This should cover any liability imposed on him or her by law for damages because of bodily injury to or death of persons and injury to or destruction of property as a result of work undertaken by such subcontractors. In addition, the contractor should provide for and on behalf of any such subcontractors protection to cover like liability imposed upon the latter as a result of their operations by means of separate and individual contractors' public liability and property damage policies. Alternatively, each subcontractor may provide satisfactory insurance on his or her own behalf to cover his individual operations.

The contractor should furnish to the state highway department evidence that the required insurance coverages have been provided. The contractor should also furnish a copy of this evidence to the railroad company or companies. The insurance specified should be kept in force until all work required to be performed has been satisfactorily completed and accepted in accordance with the contract.

In connection with crossing projects, railroad protective liability insurance should be purchased on behalf of the railroad by the contractor. Railroad protective insurance should be in conformance with appropriate state laws.

Railroad protective insurance coverage should be limited to liabilities and damages suffered by the railroad on account of occurrences arising out of the work of the contractor on or about the railroad right of way, regardless of the railroad's general supervision or control.

The maximum amount of coverage for which premiums are to be reimbursed from federal funds with respect to bodily injury, death, and property damage normally is limited to a combined amount of \$2 million per occurrence with an aggregate of \$6 million applying separately to each annual period. In cases involving real and demonstrable danger of appreciably higher risks, higher dollar amounts of coverage for which premiums will be reimbursable from federal funds will be allowed. These larger amounts will depend on circumstances and will be written for the individual project in accordance with standard underwriting practices upon approval of the FHWA division administrator.

In determining whether a larger dollar amount of coverage is necessary for a particular project, consideration should be given to the size of the project,

the amount and type of railroad traffic passing through the project area, the volume of highway traffic in the project area, and the collision experience of the contractor involved in the project.

E. Traffic Control During Construction

Traffic control for highway-rail grade crossing construction is very similar to traffic control for highway construction. The major difference is that the work area is in joint-use right of way, and the possibility of conflict exists between rail and highway traffic as well as in construction operations. Construction areas can present unexpected or unusual situations to the motorist as far as traffic operations are concerned. Because of this, special care should be taken in applying traffic control techniques in these areas.

Both railroad and highway personnel are well trained in the safety and control of their respective traffic streams. However, construction practices, agency policy, labor work rules, and state and federal regulations all contribute to the complexity of crossing work-zone traffic control. When highway construction and maintenance activities at the intersection take place on the tracks or within 15 feet of an active running rail, railroad personnel should be present. Railroad maintenance and construction of crossing signals or surfaces will often require some measure of control of highway traffic.

An open communication channel between railroad and highway personnel is essential to the coordination of crossing construction and maintenance. For example, the railroad engineering department should notify all highway agencies several weeks in advance of track resurfacing or crossing reconstruction operations that require crossings to be closed to highway traffic. The exact schedule of the track work activity should be confirmed by the railroad engineering department a few days before the actual work takes place.

Proper coordination will ensure minimal crossing closure time and will reduce the cost of work-zone traffic control activities. Highway personnel should inform railroad engineering departments of any work scheduled within the railroad right of way weeks before the work begins. The schedule should be reconfirmed with the railroad a few days before the crews are to be on the site.

If the construction or maintenance activity requires the entire crossing to be removed, the crossing should be

closed and traffic should be detoured over an alternate route or temporary bypass. Crossings on high-volume rural and urban highways should not be closed during weekdays or peak hours. Traffic control for the construction or maintenance of crossings should be the same as that used for highway construction and maintenance and should comply with the applicable requirements of the *Manual on Uniform Traffic Control Devices* (MUTCD).

Traffic safety in construction zones should be an integral and high-priority element of every project, from planning through design and construction. Similarly, maintenance work should be planned and conducted with the safety of motorists, pedestrians, workers, and train crews in mind at all times. The basic safety principles governing the design of crossings should also govern the design of construction and maintenance sites. The goal should be to route traffic through such areas with geometries and traffic control devices comparable, as nearly as possible, to those for normal crossing situations.

A traffic control plan in detail appropriate to the complexity of the work project should be prepared and understood by all responsible parties before the site is occupied. A traffic control plan is required to be included in the plans, specifications, and estimates for all federal-aid projects, as indicated in FAPG. Usually, the highway agency develops the traffic control plans. Any changes in the traffic control plan should be approved by an individual trained in safe traffic control practices.

The method for accomplishing traffic control is to be worked out between the railroad and the state or local highway agency. There is wide latitude as to which party does the work. Many states require that the agency responsible for the highway on which the crossing is located also be responsible for the preparation and implementation of the traffic control plan. This may be the state agency or a local county, city, or town. Some states require the railroad or contractor to implement the traffic control plan. It is emphasized that the individuals who prepare or implement the traffic control in work areas be trained in the requirements of MUTCD. Reimbursement for traffic control costs for a federal-aid project includes payment for force account costs and reimbursement for contractor services.

Traffic movement should be inhibited as little as practicable. Traffic control at work sites should be designed on the assumption that motorists will only reduce their speeds if they clearly perceive a need to do so. Reduced-speed zoning should be avoided as much

as practicable. Guidelines for determining speed limits in detour, transitions, and median crossovers are as follows:

- Detours and crossovers should be designed for speeds equal to the existing speed limit, if at all possible. Speed reductions should not be more than 10 miles per hour (mph) below the speed of the entering highway.
- Where a speed reduction greater than 10 mph is unavoidable, the transition to the lower limit should be made in steps of not more than 10 mph.
- Where severe speed reductions are necessary, police or flaggers may be used in addition to advance signing. The conditions requiring the reduced speed should be alleviated as soon as possible.

Frequent and abrupt changes in geometries, such as lane narrowing, dropped lanes, or main highway transitions that require rapid maneuvers, should be avoided. Provisions should be made for the safe operation of work vehicles, particularly on high-speed, high-volume highways. Construction time should be minimized to reduce exposure to potential hazards.

Motorists should be guided in a clear and positive manner while approaching and traversing construction and maintenance work areas. Adequate warning, delineation, and channelization by means of proper pavement marking, signing, and use of other devices that are effective under varying conditions of light and weather should be provided to assure motorists of positive guidance in advance of and through the work area.

Inappropriate markings should be removed to eliminate any misleading cues to drivers under all conditions of light and weather. On short-term maintenance projects, it may be determined that such removal is more hazardous than leaving the existing markings in place. If so, special attention must be paid to provide additional guidance by other traffic control measures. Flagging procedures can provide positive guidance to motorists traversing the work area and should be employed when required to control traffic or when all other methods of traffic control are inadequate to warn and direct drivers.

Each person whose actions affect maintenance and construction zone safety, from upper-level management personnel through construction and maintenance field personnel, should receive training appropriate to the job decisions each individual is required to make. Only individuals who are qualified by means of adequate training in safe traffic control practices and who have a basic understanding of the principles established

by applicable standards and regulations, including those of MUTCD, should supervise the selection, placement, and maintenance of traffic control devices in maintenance and construction areas.

Routine inspection of traffic control elements should be performed to ensure acceptable levels of operations. This inspection should verify that all traffic control elements of the project are in conformity with the traffic control plan and are effective in providing safe conditions for motorists, pedestrians, and workers.

The maintenance of roadside safety requires constant attention during the life of the construction zone because of the potential increase in hazards. To accommodate run-off-the-road incidents, disabled vehicles, or other emergency situations, it is desirable to provide an unencumbered roadside recovery area that is as wide as practical. Traffic channelization should be accomplished by the use of pavement markings and signing, flexible posts, barricades, and other lightweight devices that will yield when hit by an errant vehicle. Whenever practical, construction equipment, materials, and debris should be stored in such a manner as not to be vulnerable to run-off-the-road vehicle impact.

As with highway traffic, control of train traffic through construction areas must provide for the safety of labor forces and safe train operations. Ideally, construction and maintenance at a highway-rail grade crossing would occur under conditions with no highway or train traffic. However, this is rarely practical.

To minimize the impact on train operations, careful planning is required. The railroad should be notified well in advance of planned construction or maintenance activities. Thus, necessary work can be coordinated and proper plans can be made for the operation of train traffic.

Rail traffic is not as easily detoured as highway traffic. Highway users may be directed over an adjacent crossing, which may not be more than one mile away, or a temporary crossing surface may be inexpensively constructed adjacent to the work site.

Detours for rail traffic may greatly increase the costs of rail operations due to increased travel time and distance. Temporary trackage (shoo-fly) may be expensive to construct. At multiple-track crossings, work may sometimes be planned to close only one track to train traffic at a time and provide for the continuation of all train traffic over the remaining track. At other times, the heavy cost of temporary

railroad signaling and interlocking may preclude this solution.

Train crews are notified of construction or maintenance activities through train orders or railroad signal systems. Appropriate instructions for operating through the area are provided by the dispatcher. A railroad employee is established on the construction site as a flagman to advise of approaching trains so that labor forces may move off the track while the train passes through the area.

When planning construction or maintenance work at highway-rail grade crossings, proper coordination with the railroad is essential. The safety of highway users, highway and railroad work crews, and train crews can best be provided through the development of a work plan to meet the needs of rail and highway traffic.

1. Traffic Control Zones

When traffic is affected by construction, maintenance, utility, or similar operations, traffic control is needed to safely guide and protect highway users and workers in a traffic control zone. The traffic control zone is the distance between the first advance warning sign and the point beyond the work area where traffic is no longer affected.

Most traffic control zones can be divided into the following parts: advance warning area, transition area, buffer space, work area, and termination area. These are shown in Figure 61.

The advance warning area should be long enough to give motorists adequate time to respond to the changed conditions. This length is at least 1,500 feet in rural areas but may be a minimum of one block in urban areas.

If a lane or shoulder is closed, a transition area is needed to channelize traffic from normal highway lanes to the path required to move traffic around the work area. The transition area contains the tapers used to close lanes. A taper is a series of channelizing devices and pavement markings placed on an angle to move traffic out of its normal path. The length of a taper is determined by the speed of traffic and the width of the lane to be closed. The formulae for determining the length of a taper are:

Posted speed 40 mph or less: $L = WS$

Figure 61. Areas in a Traffic Control Zone

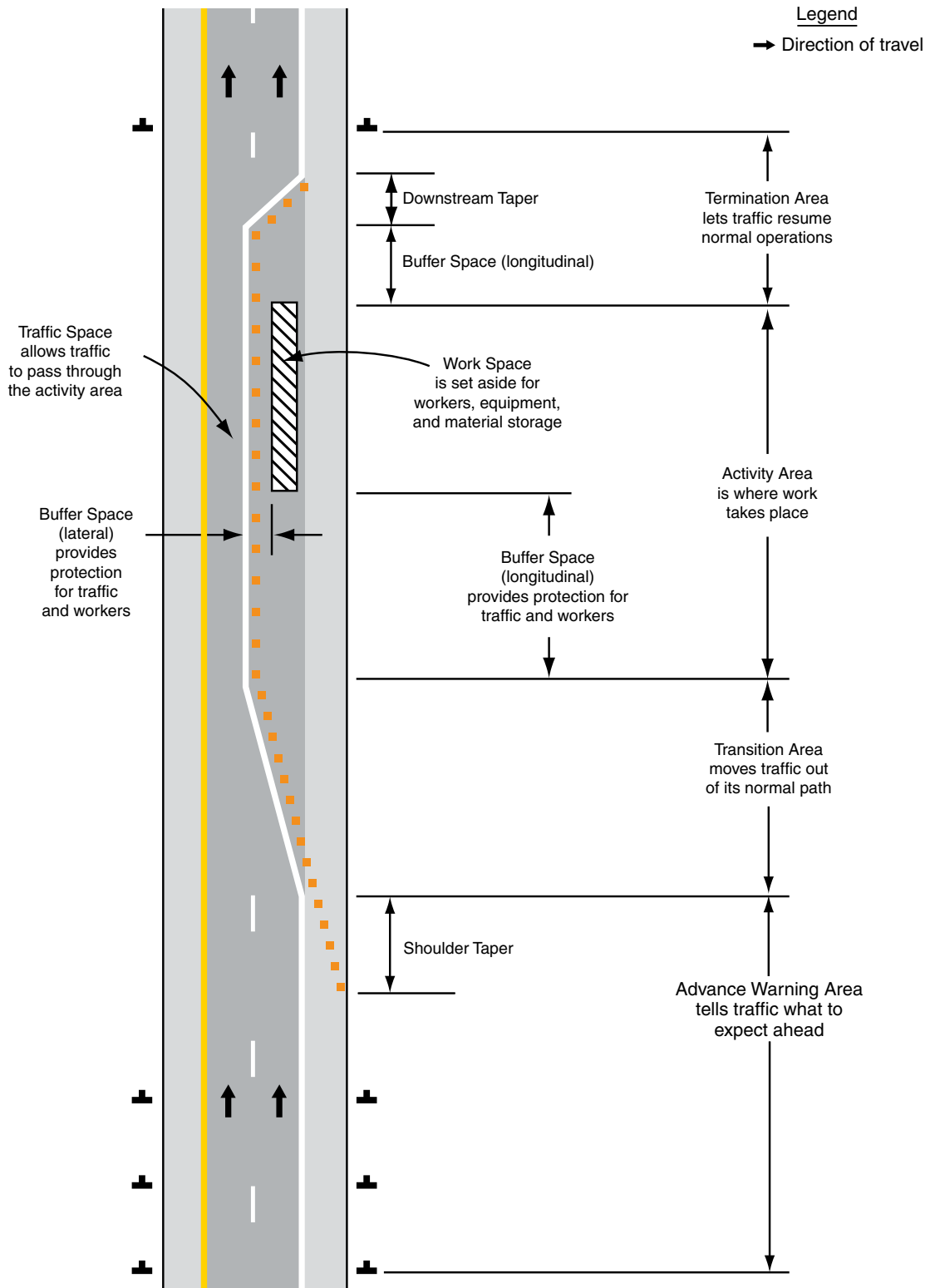

Source: Manual on Uniform Traffic Control Devices, 2003 Edition. Washington, DC: Federal Highway Administration, 2003.

Table 48. Channelizing Devices for Tapers

Speed Limit	Taper Length (L) Lane Width (feet)			Number of Channelizing Devices for Taper	Spacing of Devices Along Taper (feet)
	10	11	12		
20	70	75	80	5	20
25	105	115	125	6	25
30	150	165	180	7	30
35	205	225	245	8	35
40	270	295	320	9	40
45	450	495	540	13	45
50	500	550	600	13	50
55	550	605	660	13	55

Source: Railroad-Highway Grade Crossing Handbook, Second Edition. Washington, DC: U.S. Department of Transportation, Federal Highway Administration, 1986.

Posted speed 45 mph or more: $L = \frac{WS^2}{60}$ (15)

where:

- L = taper length
- W = width of lane or offset
- S = posted speed or off-peak 85th-percentile speed

The recommended number and spacing of channelizing devices for various speeds and widths of closing are given in Table 48.

A two-way traffic taper is used in advance of a work area that occupies part of a two-way road in such a way that the remainder of the road is used alternately by traffic in either direction. A short taper is used to cause traffic to slow down by giving the appearance of restricted alignment. One or more flaggers are usually employed to assign the right of way. Two-way traffic tapers should be 50 to 100 feet long, with channelizing devices spaced at a maximum of 10 to 20 feet.

The buffer space is the open or unoccupied space between the transition and work areas and provides a margin of safety for both traffic and workers. Channelizing devices should be placed along the edge of the buffer space, spaced (in feet) two times the posted speed limit.

The work area is the portion of the highway that contains the work activity, is closed to traffic, and is set aside for exclusive use by workers, equipment, and construction materials. The work area is usually delineated by channelizing devices or shielded by barriers to exclude traffic and pedestrians.

The termination area provides a short distance for traffic to clear the work area and return to normal traffic lanes. A downstream taper may be placed in the termination area to shift traffic back to its normal path.

2. Traffic Control Devices

Signs. Regulatory and warning signs are used in construction work areas. Regulatory signs impose legal restrictions and may not be used without permission from the authority having jurisdiction over the highway. Warning signs are used to give notice of conditions that are potentially hazardous to traffic. Typical warning signs used in construction work areas are shown in Figure 62.

The high conspicuity of fluorescent orange colors provides an additional margin of safety by producing a high visual impact in hazardous areas. Therefore, where the color orange is specified for use in traffic control for construction and maintenance operations, it is acceptable to utilize materials having fluorescent red-orange or yellow-orange colors.

Signs may be attached to posts or portable supports that are lightweight, yielding, or breakaway. The minimum height requirements for signs attached to posts are shown in Figure 62. Signs on portable supports are required by MUTCD to be at least 1 foot above the highway.

Pavement markings. Pavement markings and delineators outline the vehicular path and, thus, guide the motorist through the construction area. Pavement markings include lane stripes, edge

Figure 62. Typical Signs for Traffic Control in Work Zones

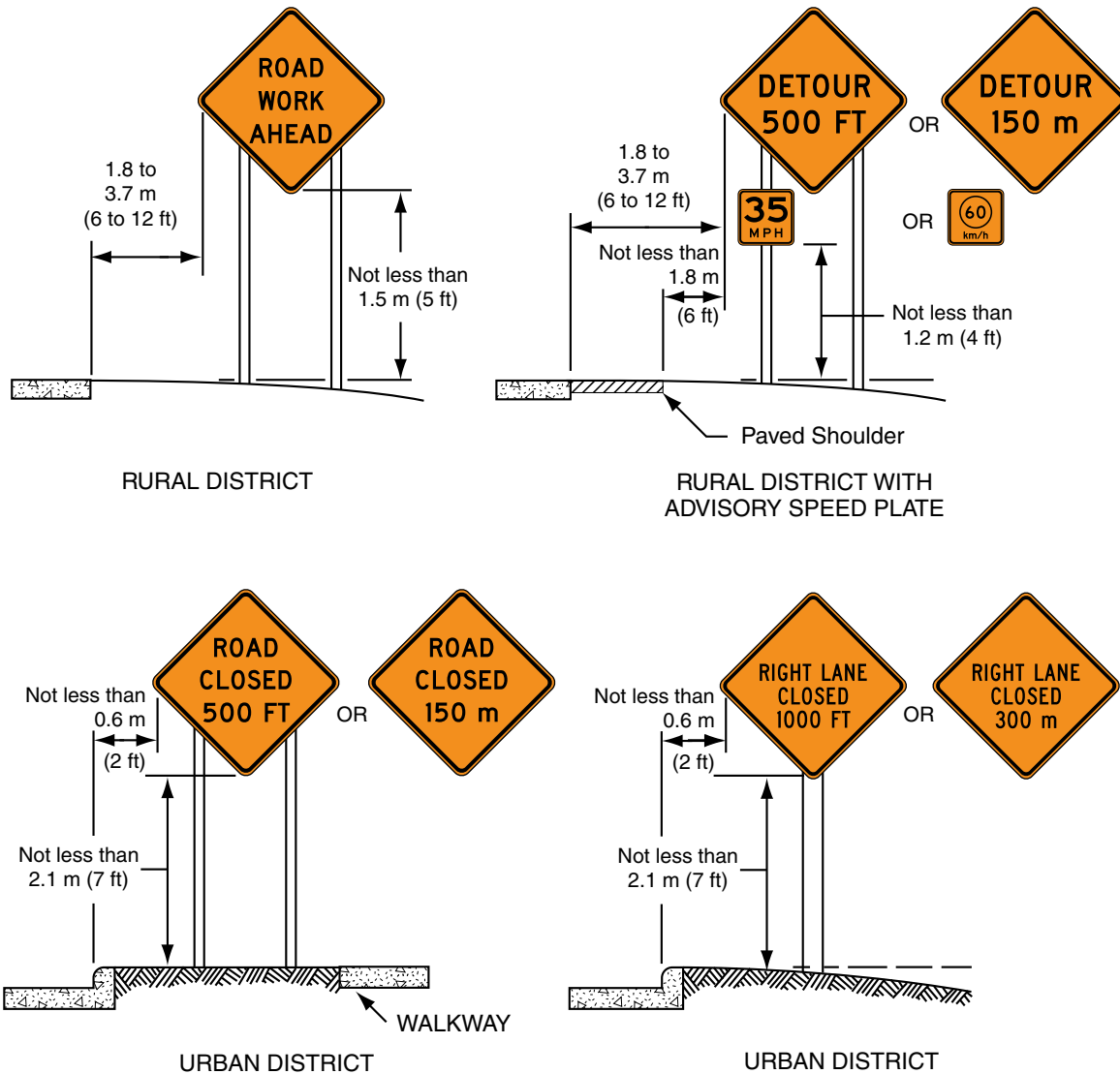

Source: Manual on Uniform Traffic Control Devices, 2003 Edition. Washington, DC: Federal Highway Administration, 2003.

stripes, centerline stripes, pavement arrows, and word messages. Markings are made of paint (with bead reflectorization); raised reflectorized markers; preformed adhesive-backed reflectorized tape; cold preformed reflectorized plastics; hot reflectorized plastics; epoxies; and other materials placed by heating and spraying.

The standard markings planned for the road should be in place before opening a new facility to traffic. Also, if revised lane patterns are planned for the work zone, temporary markings should be placed before the traffic

is changed. Where this is not feasible, such as during the process of making a traffic shift or carrying traffic through surfacing operations, temporary delineation may be accomplished with lines of traffic cones, other channelizing devices, or strips of adhesive-backed reflectorized tape.

When pavement placed during the day is to be opened to traffic at night, and permanent striping cannot be placed before the end of work, a temporary stripe should be applied to provide an indication to the driver

of the location of the lane or centerline. Standard marking patterns are most desirable for this use. On rock-screened seal coats, striping should be applied following removal of excess screenings.

For relatively long-term use, or when the surface is to be covered later with another layer, reflectorized traffic paint or preformed adhesive-backed tape, with or without raised pavement markers, should be considered. For relatively short-term use and when frequent shifts are to be made, adhesive-backed reflectorized tape is useful. Raised pavement markers may be used to form the pavement markings to supplement marked stripes. High speeds and volumes of traffic may justify raised markers for even comparatively short periods. They are particularly valuable at points of curvature and transition.

Pavement arrows are useful in guiding traffic when the traveled way does not coincide with the configuration of the exposed surface area, such as when the color of the transition pavement is different from the existing pavement. Pavement arrows are especially useful on a two-way, undivided roadway to remind the driver of opposing traffic. "Two-Way Traffic" signs should be used in conjunction with the arrows for the application. The arrows should be completely removed once the two-way traffic condition is no longer needed.

Whenever traffic is shifted from its normal path, whether a lane is closed, lanes are narrowed, or traffic is shifted onto another roadway or a detour, conflicting pavement markings should be removed. Exceptions to this may be made for short-term operations, such as a work zone under flagger control or moving or mobile operations. Use of raised pavement markings or removable markings may be economical because they are usually easier to remove when no longer needed.

Delineators. Delineators are reflective units with a minimum dimension of approximately 3 inches. The reflector units can be seen up to 1,000 feet under normal conditions when reflecting the high beams of motor vehicle headlights. Delineators should be installed about 4 feet above the roadway on lightweight posts.

Delineators should not be used alone as channelizing devices in work zones but may be used to supplement these channelizing devices in outlining the correct vehicle path. They are not to be used as a warning device. To be effective, several delineators need to be seen at the same time. The color of the delineator should be the same as the pavement marking that it supplements.

Channelizing devices. Channelizing devices consist of cones, tubular markers, vertical panels, drums, barricades, and barriers. Cones are lightweight devices that may be stacked for storage, are easy to place and remove, and are a minor impedance to traffic flow. They are at least 18 inches high. Cones that are 28 inches high should be used on high-speed roadways, on all facilities during hours of darkness, or whenever more conspicuous guidance is needed. Cones are reflectorized for use at night with a 6-inch-wide reflectorized band placed no more than 3 inches from the top or with a lighting device.

Tubular markers are also lightweight, easy to install, and are a minor impedance to traffic flow. They must be set in weighted bases or fastened to the pavement. They should be at least 18 inches high, with taller devices preferred for better visibility. Markers should be reflectorized for use at night with two reflectorized bands, 3 inches in width, placed no more than 2 inches from the top and with no more than 6 inches between the bands.

Vertical panels are 8 to 12 inches in width and a minimum of 24 inches in height. They are advantageous in narrow areas where barricades and drums would be too wide. They are mounted on lightweight posts driven into the ground or placed on lightweight portable supports. The orange and white stripes on vertical panels slope down toward the side on which traffic is to pass. They should be reflectorized as barricades and installed such that the top is a minimum of 36 inches above the highway.

Drums are highly visible and appear to be formidable objects, thus commanding the respect of motorists. They should be marked with horizontal orange and white stripes that are reflectorized and 4 to 8 inches wide. The drum must have at least two sets of orange and white stripes but can also have nonreflectorized spaces up to 2 inches wide between the stripes.

Barricades should be constructed of lightweight materials and are classified as Types I, II, and III. Types I and II are used for either channelizing or marking hazards. Type III barricades are used for road closures. The barricade rails have alternating orange and white reflectorized stripes that slope down toward the side on which traffic is to pass.

Barriers provide a physical limitation through which a vehicle would not normally pass. They are used to keep traffic from entering a work area or hitting an exposed object or excavation. They provide protection for workers and construction and separate two-way traffic. They are usually made of concrete or metal and are designed to contain and redirect an errant vehicle.

Exposed ends of barriers should have crash cushions to protect traffic or flared ends provided by extending the barrier beyond the clear roadside recovery area. Two types of crash cushions used in work zones are sand-filled plastic barriers and the portable guard rail energy absorbing terminal.

High-level warning devices are tall, portable stands with flags and/or flashing lights. Three flags, 16-inch-square or larger, are mounted at least 8 feet above the highway.

Lighting devices. Three types of warning lights may be used in construction areas. Flashing lights are appropriate for use on a channelizing device to warn of an isolated hazard at night or call attention to warning signs at night. High-intensity lights are appropriate to use on advance warning lights during day and night. Steady-burn lights are appropriate for use on a series of channelizing devices or on barriers that either form the taper to close a lane or shoulder or keep a section of lane or shoulder closed, and are also appropriate on the channelizing devices alongside the work area at night.

Work vehicles in or near traffic areas are hazards and should be equipped with emergency flashers, flashing lights, strobes, or rotating beacons. High-intensity lights are effective during both day and night. The laws of the agency having jurisdiction over the street or highway should be checked concerning requirements for flashing vehicle lights. These lights should be used in addition to other channelizing and warning devices. However, in some emergency situations where the work will be in progress for a short time, these lights may be the only warning device.

Flashing arrow panels are signs with a matrix of lights capable of either flashing or sequential displays. They are effective during day and night for moving traffic out of a lane to the left or the right, and may be used for tapered lane closures. These arrow panels should not be used when no lanes are closed, when there is no interference in traffic flow, or when a flagger is controlling traffic on a normal two-lane two-way road.

Flagging. Flagging should be used only when required to control traffic or when all other methods of traffic control are inadequate to warn and direct drivers. The procedures for flagging traffic are contained in MUTCD Section 6E. The standard signals to be used by flaggers are illustrated in Figure 63. Flaggers should be in sight of each other or have direct communication at all times.

A number of hand signaling devices, such as STOP/SLOW paddles, lights, and red flags are used to control traffic through work zones. The sign paddle bearing the clear messages “Stop” or “Slow” provides motorists

with more positive guidance than flags and should be the primary hand-signaling device. The use of flags should be limited to emergency situations and at spot locations that can best be controlled by a single flagger.

When a highway-rail grade crossing exists either within or in the vicinity of a temporary traffic control zone, lane restrictions, flagging, or other operations shall not be performed in a manner that would cause vehicles to stop on the railroad tracks, unless a law enforcement officer or flagger is provided at the highway-rail grade crossing to minimize the possibility of vehicles stopping on the tracks, even if automatic warning devices are in place.¹²⁹

3. Typical Applications

Typical applications of traffic control devices in crossing work zones are shown in Figures 64 through 67. The dimensions shown in these figures may be adjusted to fit field conditions in accordance with the guidelines presented in MUTCD and the *Traffic Control Devices Handbook*. When numerical distances are shown for sign spacing, the distances are intended for rural areas and urban areas with a posted speed limit of 45 mph or more. For urban areas with a posted speed of 45 mph or less, the sign spacing should be in conformance with Table 49.

Table 49. Sign Spacing for Urban Areas

Speed Limit	Sign Spacing	
	X	Y
30 mph or less	300 feet	200 feet
35 mph or 40 mph	450 feet	300 feet

Source: Railroad-Highway Grade Crossing Handbook, Second Edition. Washington, DC: U.S. Department of Transportation, Federal Highway Administration, 1986.

Signs with specific distances shown should not be used if the actual distance varies significantly from that shown. The word message “Ahead” should be used in urban areas and in other areas where a specific distance is not applicable. Standard crossing pavement markings are not shown in the figures for clarity and should be utilized where appropriate. All applicable requirements for traffic control in work areas set forth in MUTCD shall apply to construction and maintenance of crossings. Additional traffic control devices other than those shown in the figures should be

¹²⁹ *Manual on Uniform Traffic Control Devices, 2003 Edition.* Washington, DC: FHWA, 2003.

Figure 63. Use of Hand Signaling Devices by Flagger

PREFERRED METHOD
STOP/SLOW Paddle

EMERGENCY SITUATIONS ONLY
Red Flag

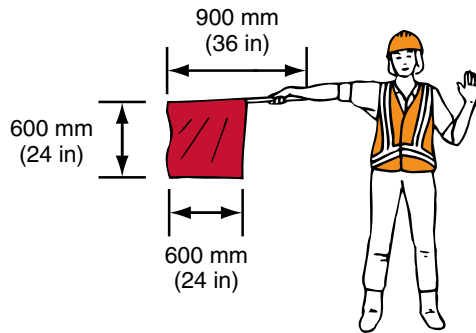

TO STOP TRAFFIC



TO LET TRAFFIC PROCEED

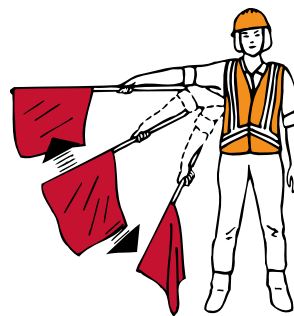

TO ALERT AND SLOW TRAFFIC

Source: Manual on Uniform Traffic Control Devices, 2003 Edition. Washington, DC: Federal Highway Administration, 2003.

Figure 64. Crossing Work Activities, Two-Lane Highway, One Lane Closed

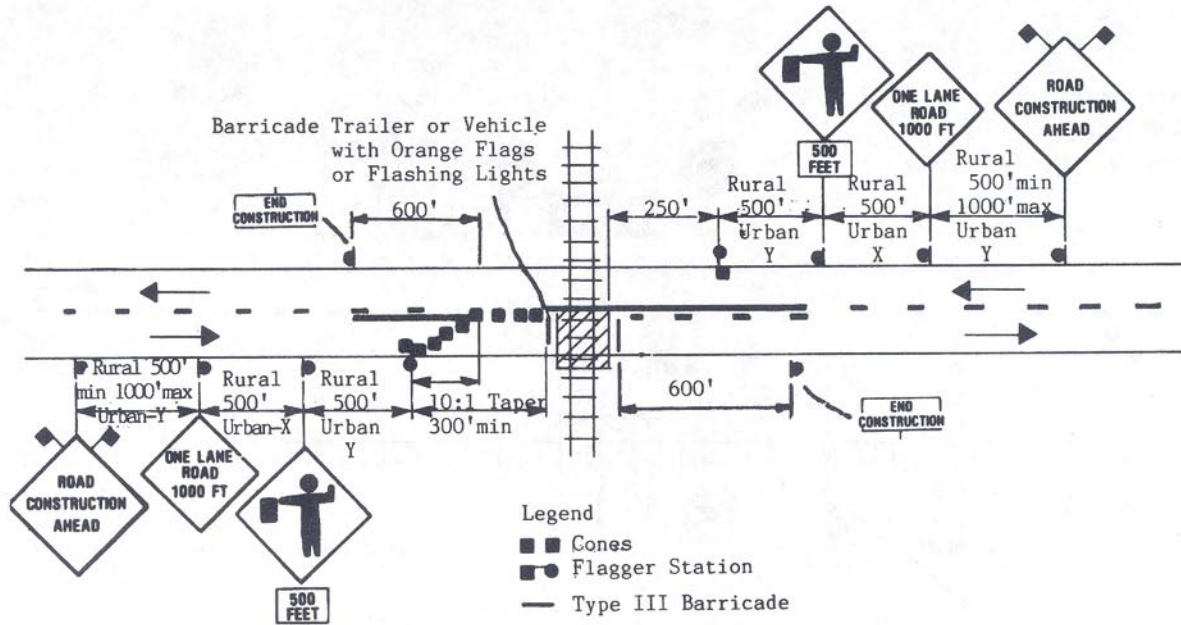
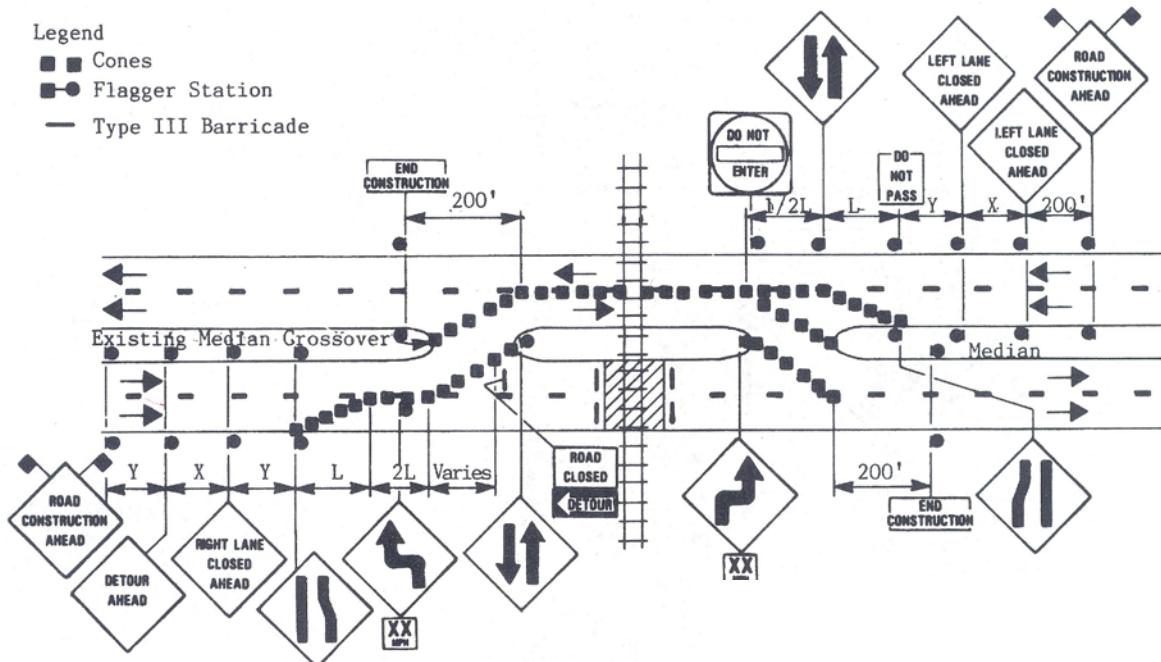

Figure 65. Crossing Work Activities, Multilane Urban Divided Highway, One Roadway Closed, Two-Way Traffic



Source: Railroad-Highway Grade Crossing Handbook, Second Edition. Washington, DC: U.S. Department of Transportation, Federal Highway Administration, 1986.

Figure 66. Crossing Work Activities, Closure of Side Road Crossing

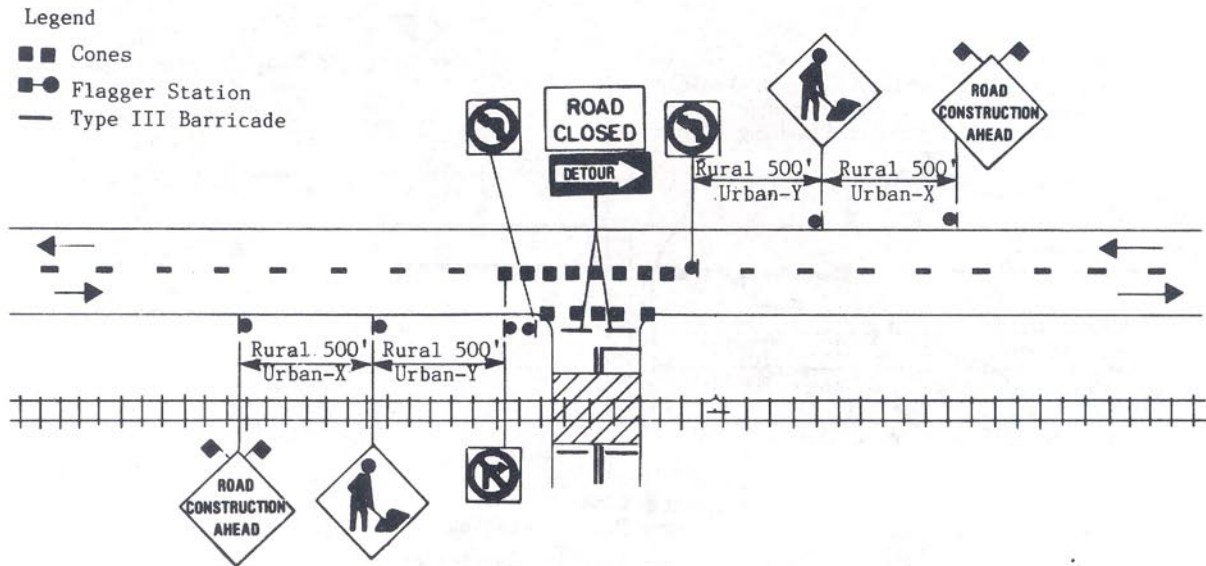
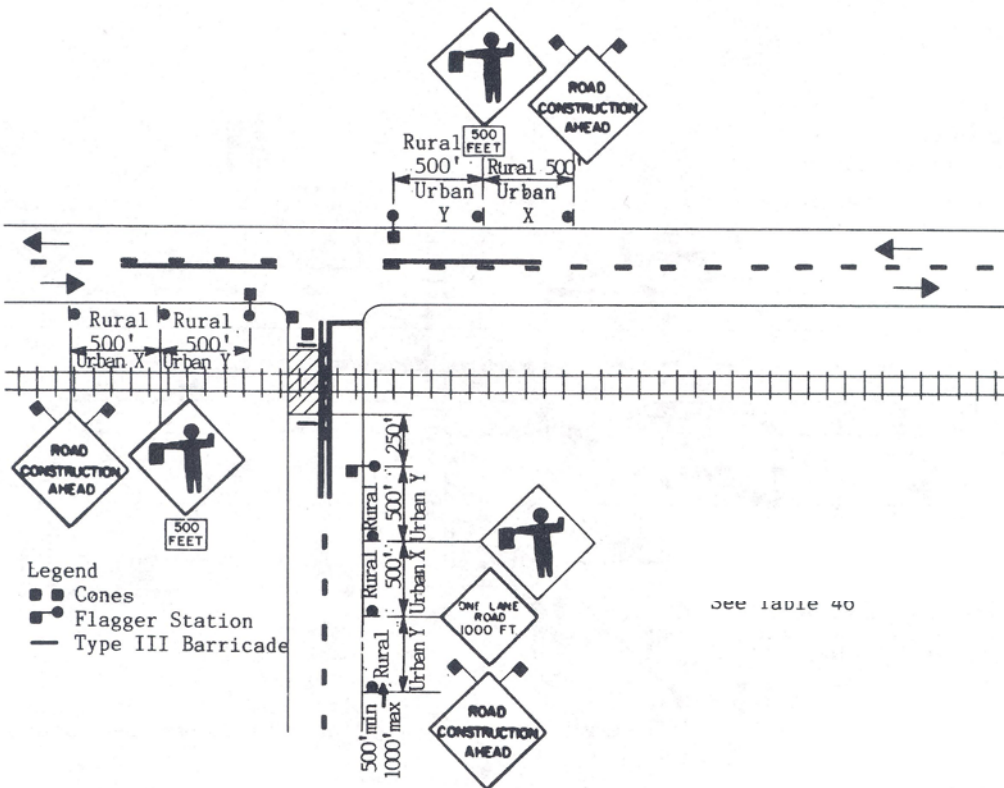

Figure 67. Crossing Work Activities, One Lane of Side Road Crossing Closed



Source: Railroad-Highway Grade Crossing Handbook, Second Edition. Washington, DC: U.S. Department of Transportation,

provided when highway and traffic conditions warrant. These devices should conform to the requirements of MUTCD. All traffic control devices that are not applicable at any specific time shall be covered, removed, or turned so as to not be visible to the motorist.

F. Program Development

Program development is the portion of the total process concerned with selecting the specific improvement projects (including the type of improvement to be made along with the estimated cost of such improvements) to be included in a highway-railroad grade crossing improvement program.

Program implementation is the portion of the total process concerned with making specific improvements at specific highway-railroad grade crossings.

Some method should be used to establish a priority ranking of crossings to be considered for improvement. The prioritizing of a crossing for improvement can be done individually, or the corridor approach can be used. The corridor approach considers a number of crossings along a railroad line. Utilizing this method, the potential for improving the efficiency of railroad and highway operations may be considered.

The total program should include more projects than can reasonably be funded. This is to ensure that substitutions can be made in the priority list following field evaluation of the crossings by the diagnostic team.

To aid in the programming of projects, a resource allocation model has been developed to assist in making allocation decisions. The methodology, using a highway-railroad crossing accident prediction formula, traffic control device system effectiveness, and cost parameters, provides a funding priority ranking of projects. On the state and local level, it can be used to prioritize crossing projects and options by their benefit-cost ratio.

It should be emphasized that, in the use of ranking procedures (hazard indices, resource allocation), the algorithm does not dictate the final decision. These tools should be considered only as an aid to state and local officials and railroad management for making decisions. Local conditions and the judgment of state and local officials should play a major role in this evaluation process.¹³⁰

G. References

Federal-Aid Policy Guide. Washington, DC: Federal Highway Administration (FHWA), updated periodically.

Federal Highway Administration Survey of Region and Division Offices, unpublished, 1984.

Manual on Uniform Traffic Control Devices, 2003 Edition. Washington, DC: FHWA, 2003.

Traffic Control Devices Handbook. Washington, DC: FHWA, 1983.

¹³⁰ *Traffic Control Devices Handbook*. Washington, DC: Institute of Transportation Engineers, 2001.

Maintenance Program*

VII

A. Railroad Responsibility*

The highway-rail crossing is unique to other highway features in that railroads install, operate, and maintain the traffic control devices located at the crossing. Even though a large portion of the cost of designing and constructing crossings, including traffic control devices, is assumed by the public, current procedures place maintenance responsibilities for devices located in the railroad right of way with the railroad. The public agency having jurisdiction terminates its responsibility for the roadway at the crossing surface.

B. Highway Authority Responsibility

Traffic control devices on the approach, in most instances, are the responsibility of the public agency. Maintenance-sharing with highway or other local authorities is typically included in construction and management (C&M) agreements developed prior to initiation of final design and construction of improvements.

The highway agency is usually responsible for maintaining the highway approaches, all traffic control devices on the approaches (except the crossbuck sign), illumination, and special signing at the crossing, such as the “Exempt” sign, STOP sign, or “Do Not Stop on Tracks” sign.

1. Traffic Control Devices

Traffic control devices on approaches to highway-rail crossings require regular inspection and maintenance. Pavement markings, if present, may need to be renewed annually. Signs on the approaches will gradually lose their retroreflectivity and should be

inspected at night or checked with a retroreflectometer on some regular basis, such as annually, to assure that they retain the proper brightness.

Interconnected traffic signals and active advance warning signs should be jointly inspected on a regular basis by state and railroad signal personnel. County or municipal representatives need to be included in this inspection if they share the responsibility for operation or maintenance of the device. Operation of the preempt signal should be checked any time a railroad or roadway signal maintainer visits the crossing or the highway intersection. The highway agency and the local law enforcement agency should have a railroad company’s telephone number available 24 hours per day to report railroad signal damage or malfunctions.

Passive flashers and roadway luminaires should be observed on a regular basis and re-lamped as necessary. Road crews should be alert for missing or damaged devices and for results of acts of vandalism that deface the devices or interfere with their effectiveness. Road crews should also drive the approach roadway to assure that vegetation does not obscure the traffic control devices from approaching drivers and should trim or cut trees or brush as necessary.

Higher-quality materials, such as improved sign sheeting and preformed or thermoplastic pavement marking materials, can offer dual benefits by increasing the effectiveness of the devices while reducing the required number of maintenance cycles.

The Federal Highway Administration (FHWA) has been developing standards on retroreflectivity of signs, which include minimum values to be provided and maintained. FHWA recently published a Supplemental Notice of Proposed Amendments to the *Manual on*

* Includes previously unpublished materials provided by Ray Lewis, West Virginia Department of Transportation.

Uniform Traffic Control Devices. The provisions were out for comment at the time this handbook was prepared.¹³¹

2. Roadside Clear Zone

The roadside clear zone serves the dual purpose of increasing the visibility of the crossing and traffic control devices and providing a safe recovery area for an errant motorist. The clear zone should be kept free of brush; trees that are more than 100 millimeters (4 inches) in diameter or that may obscure traffic control devices; and rocks, eroded areas, standing water, or other defects that may entrap an errant vehicle or lead to deterioration of the roadway or track structure.

The maintenance of the sight triangle, beyond highway and railroad right of way, presents a unique problem. Except for the portions on the rights of way, this involves private property. The removal of trees, brush, crops, buildings, signs, storage facilities, and other obstructions to the driver’s view requires access to the property and an agreement with the landholder for the removal of the obstruction.

3. Roadside Approaches

Most maintenance on roadway approaches will be similar to that carried out on any roadway. There are a few special considerations maintenance forces need to keep in mind:

- Roadway maintenance equipment can damage crossing surfaces or the adjacent track. Repairs adjacent to the crossing should be done with care.
- Maintenance personnel should be aware of the potential for train movements and should be alert for trains. It may be necessary to station an employee at the crossing to warn the crew of train movements or to coordinate activities with the railroad.
- Particular care needs to be taken not to block or interfere with proper drainage from the crossing or track structure when maintaining pipes and ditches.
- Snow removal and ice control should be done with care. Snow must not be “windrowed” across the tracks. Snowplows can damage crossing surfaces. Chemicals can corrode track and fittings and can short-out track circuits. Snow and slush should not be pushed or

carried onto the crossing. It may be necessary for personnel with hand tools to remove ice or packed snow from the crossing flangeways.

- Where possible, resurfacing operations should be coordinated with the railroad. Resurfacing lifts should be “heeled in” near the crossing so as not to leave the crossing surface in a hole or dip. Drainage should be checked to assure that the additional roadway height has not directed water onto the crossing surface. All necessary steps should be taken to prevent interference between resurfacing equipment and personnel and trains.

4. Reassessment and Periodic Review

The highway-rail grade crossing represents a discontinuity in both the highway pavement and the railroad tracks structure. Highway maintenance personnel need to be aware of the design, operational, safety, and maintenance issues surrounding these sites. The roadway maintenance supervisor should pay particular attention to the grade crossings under his or her jurisdiction and coordinate with the railroad as necessary to resolve any problems. The maintenance supervisor should also contact the grade crossing program administrator as necessary should any improvements be desired.

C. References

Federal Highway Administration Survey of Region and Division Offices, unpublished, 1984.

Maintenance Cost Study of Railroad-Highway Grade Crossing Warning Systems. Washington, DC: Association of American Railroads, October 1982.

¹³¹ 23CFR Part 655, FHWA Docket No. FHWA-2003-15149, Federal Register, May 8, 2006,

Evaluation of Projects and Programs

VIII

An integral part of any highway-rail grade crossing improvement program is the evaluation of individual projects and the overall program. The Federal-Aid Policy Guide (FAPG) specifies that each state's highway safety improvement program should include an evaluation of the program. This evaluation component is to include a determination of the effects the improvements have in reducing collisions, collision potential, and collision severity. This process should include:

- the cost of and the safety benefits derived from the various means and methods used to mitigate or eliminate hazards;
- a record of collision experience before and after the implementation of a highway safety improvement project; and
- a comparison of collision numbers, rates, and severity observed after the implementation of a highway safety improvement project with the collision numbers, rates, and severity expected if the improvement had not been made.

In addition, the evaluation program is to include an annual evaluation and report of the state's overall safety improvement program and the state's progress in implementing the individual federal programs, such as the Section 203 crossing program.

Evaluation is an assessment of the value of an activity as measured by its success or failure in achieving a predetermined set of goals or objectives. The ultimate goal of evaluation is to improve the agency's ability to make future decisions regarding the improvement program. These decisions can be aided by conducting formal effectiveness and administrative evaluations of ongoing and completed improvement projects and programs.

In the *Highway Safety Evaluation: Procedural Guide*, two types of evaluation are addressed:

effectiveness evaluation and administrative evaluation. These two types will be discussed in this chapter only in sufficient detail for the user to be aware of the need and the procedures. However, the reader should refer to the procedural guide for more details. Also, the following references provide more useful information on safety evaluation procedures:

- Lunenfeld, H. *Evaluation of Traffic Operations, Safety and Positive Guidance Projects*. Washington, DC: Federal Highway Administration (FHWA), Report No. FHWA-10-80-1, October 1980.
- Tarrants, W.E. and C.H. Veigel. *The Evaluation of Highway Traffic Safety Programs*. Washington, DC: National Highway Traffic Safety Administration, Report DOT-HS-80525, February 1978.
- Council, F.M., et al. *Accident Research Manual*. Washington, DC: FHWA, Report FHWA/RD-80/016, February 1980.
- Berg, W.D. *Experimental Design for Evaluating the Safety Benefits of Railroad Advance Warning Signs*. Washington, DC: FHWA, Report FHWA-RD-7978, April 1979.

A. Project Evaluation

Highway-rail grade crossing improvements that have as their objective the enhancement of safety should be evaluated as to their effectiveness. This can be done for individual projects and should be done for the overall improvement program. An effectiveness evaluation for safety purposes is the statistical and economic assessment of the extent to which a project or program achieves its ultimate safety goal of reducing the number and/or severity of collisions. It also can be expanded to include an assessment of the intermediate effects related to safety enhancement. The latter

type of evaluation becomes particularly relevant for crossings because the low number of collisions occurring at a crossing may preclude any meaningful collision-based evaluation of individual crossings or a small number of them.

The procedural guide lists seven functions that should be followed in conducting an effectiveness evaluation:

- Develop an evaluation plan.
- Collect and reduce data.
- Compare measures of effectiveness.
- Perform statistical tests.
- Perform economic analyses.
- Prepare evaluation documents.
- Develop and update a database.

The essential elements of the principal functions are described below.

The evaluation plan addresses issues such as the selection of projects for evaluation, project purposes, evaluation objectives and measures of effectiveness (MOEs), experimental plans, and data requirements.

Although it would be desirable to evaluate all improvement projects, manpower and fiscal capabilities do not always permit this. Consequently, when selecting projects for evaluation, the following factors should be considered:

- Improvement types that are questionable as to their effectiveness.
- Projects that have sufficient data necessary for statistical analysis.
- Projects that are directly related to collision reduction.

If the number of collisions occurring before the improvement is too few to allow a significant reduction of collisions to occur, the project may be evaluated along with other similar projects. This is frequently the situation with crossings because they experience very few collisions. If projects are aggregated for evaluation, it is essential that:

- Countermeasures for each be identical.
- Types of locations be similar.
- Project purposes be similar.

The experimental plan selected should be consistent with the nature of the project and the completeness and availability of data. The most common experimental plans for evaluating safety improvement projects are a before-and-after study with control sites and a before-and-after study.

The most desirable MOE for crossing safety improvements would be the reduction of collision frequency or severity. However, because a long period of time may be required to amass an adequate sample size, especially for individual projects, evaluations can be made based on other measures such as:

- Traffic performance—speed, stopping behavior, and conflicts; or
- Driver behavior—looking, compliance, and awareness.

The evaluation plan describes the types and amounts of data necessary for the evaluation. Data for the “before” situation could be obtained from the engineering study (see Chapter III) used to assist in determining the crossing problem and appropriate improvement. Additional data, if not available from historical records, will have to be collected before the improvement is made. If the MOE involves collision data, several years of data would be required. Traffic and driver behavior data can be collected four to six weeks after project implementation.

The effect of the project(s) on the selected MOE must be determined. Computations are made to determine the expected value of the MOE if the project(s) had not been implemented, and the difference between the expected MOE and the actual observed value of the MOE. This difference should then be tested to determine if it is statistically significant.

An important objective of an effectiveness evaluation is to obtain a complete picture of how well the completed project is performing from a safety standpoint. Economic analysis provides another perspective. From such analysis, an assessment of cost and collision reduction effects, in combination, may be made. This aspect of an evaluation is very important because it is possible to have a very effective project that is cost-prohibitive in terms of future use under similar circumstances.

There are many economic analysis techniques. The two most commonly used for evaluating completed highway safety improvement projects are the benefit-cost and cost-effectiveness methods.

An effectiveness database is an accumulation of project results that are directly usable as input to future project selection. The database:

- Contains pertinent information on the collision-reducing capabilities of countermeasures and/or projects.
- Must be continually updated with new

- effectiveness evaluation information.
- Should only contain evaluation results from reliable and properly conducted evaluations.

With such a database, collision reduction factors can be established and refined over time. These factors in turn can be used in determining the most cost-effective improvements.

B. Program Evaluation

The preceding section outlined the process for conducting evaluations of one or more improvement projects. This evaluation process can and should be applied to the entire crossing improvement program or components of it. The entire program would consist of activities including physical improvements to the crossing, changes in railroad or highway traffic operations, and changes in law enforcement and driver education.

Throughout the program, it may be useful for the policy-maker to identify whether certain specific program subsets are effective. These program subsets could include types of improvements such as:

- Installation of flashing lights.
- Relocation of crossing.
- Illumination.
- Sight distance improvements.
- Combinations of two or more types.

The steps and procedures in conducting the program (or subset of the program) effectiveness evaluation are essentially the same as for projects. FHWA's *Highway Safety Evaluation: Procedural Guide* should be referred to for details.

C. Administrative Evaluation

This evaluation is the assessment of the scheduling, design, construction, and operational review activities undertaken during the implementation of the crossing improvement program. It evaluates these activities in terms of actual resource expenditures, planned versus actual resource expenditures, and productivity.

In the FHWA procedural guide, eight steps are recommended for administrative evaluation:

- Select evaluation subjects.
- Review project (program) details.
- Identify administrative issues.
- Obtain available data sources.

- Prepare administrative data summary tables.
- Evaluate administrative issues.
- Prepare and distribute the evaluation report.
- Develop and update database.

D. References

Berg, William D. *Experimental Design for Evaluating the Safety Benefits of Railroad Advance Warning Signs*. Washington, DC: Federal Highway Administration (FHWA), Report FHWA-RD79-78, April 1979.

Council, F.M., et al. *Accident Research Manual*. Washington, DC: FHWA, Report FHWA/RD-80/016, February 1980.

Federal-Aid Policy Guide. Washington, DC: FHWA, updated periodically.

Goodell-Grivas, Inc. *Highway Safety Evaluation: Procedural Guide*. Washington, DC: FHWA, FHWA-TS-81-219, October 1980.

Lunefeld, H. *Evaluation of Traffic Operations, Safety and Positive Guidance Projects*. Washington, DC: FHWA, Report No. FHWA-10-80-1, October 1980.

Tarrant, W.E. and C.H. Veigel. *The Evaluation of Highway Traffic Safety Administration*. Report DOT-HS80-525, February 1978.

Special Issues

IX

Several issues are important to highway-rail grade crossing safety and operations that either were not specifically covered in previous chapters or warrant special consideration. These include private crossings; short-line railroads; high-speed rail corridors; pedestrians; bicycles and motorcycles; special vehicles; low-cost active devices; and intelligent transportation system (ITS) applications.

A. Private Crossings

Private highway-rail grade crossings are on roadways not open to use by the public nor maintained by a public authority. According to the U.S. Department of Transportation (U.S. DOT) National Highway-Rail Crossing Inventory, there were 97,306 private crossings in the United States in 2005. Usually, an agreement between the land owner and the railroad governs the use of the private crossing. Typical types of private crossings are as follows:

- Farm crossings that provide access between tracts of land lying on both sides of the railroad.
- Industrial plant crossings that provide access between plant facilities on both sides of the railroad.
- Residential access crossings over which the occupants and their invitees reach private residences from another road, frequently a public road paralleling and adjacent to the railroad right of way.
- Temporary crossings established for the duration of a private construction project or other seasonal activity.

In some instances, changes in land use have resulted in expansion of a crossing's use to the extent that it has become a public crossing, as evidenced by frequent use by the general public. This may occur whether

or not any public agency has accepted responsibility for maintenance or control of the use of the traveled way over the crossing. The railroad and highway agency should continually review the use of private crossings so that mutual agreement is obtained on the appropriate classification. If the general public is making use of a crossing, appropriate traffic control devices should be installed for warning and guidance. Usually, state and federal funds are not available for use at private crossings.

The number of collisions at private crossings represents a small portion of all crossing collisions; however, safe design and operation at private crossings should not be overlooked. Very few private crossings have active traffic control devices and many do not have signs. Typically, they are on narrow gravel roads, often with poor roadway approaches.

At present, responsibilities for private highway-rail crossings are not clearly understood or consistently applied. This is an institutional problem that has impeded safety improvement programs at private crossings. Between 1982 and 1991, collisions at private highway-rail crossings ranged from a high of 648 (in 1984) to a low of 480 (in 1990). During this period, safety improvement programs at public crossings effected a reduction in collisions of approximately 26 percent. Private crossing collisions also declined during this period but only by 16 percent.

In 2004, there were 412 collisions, 33 fatalities, and 136 injuries at private crossings. These represent reductions, since 2000, of 9.8 percent in collisions, 40.0 percent in fatalities, and 2.9 percent in injuries, as shown in Table 50.

As with collisions at public crossings, the majority of collisions at private crossings involved automobiles. Table 51 gives the number of collisions and casualties by roadway user for 2004.

Table 50. Collisions at Private Crossings, 2000–2004

Year	Collisions	Fatalities	Injuries
2000	457	55	140
2001	369	30	115
2002	355	39	132
2003	367	32	112
2004	412	33	136

Source: Federal Railroad Administration Safety Data Website (safetydata.fra.dot.gov/officeofsafety).

Historical data indicate that approximately 60 percent of motor vehicle collisions occurred during daylight, about one-third occurred during darkness, and the remaining share occurred during either dusk or dawn. Most of the collisions involving motor vehicles (137, or 38.3 percent) occurred at crossings with STOP signs, as shown in Table 52. Collision rates (number of collisions at crossings with each type of traffic control device divided by number of crossings with that type of traffic control device) cannot be determined for private crossings because no national statistics are kept on the type of traffic control devices at private crossings.

Some states and railroads have established minimum signing requirements for private crossings. Typically, these signs consist of a crossbuck, STOP sign, and/or a warning against trespassing. California and Oregon public utility commissioners use a standard highway STOP sign together with a sign indicating that the crossing is a private crossing. A typical configuration is shown in Figure 68.

Table 52. Motor Vehicle Collisions at Private Crossings by Traffic Control Device, 2004

Traffic control device	Collisions	Percent
Automatic gates	15	4.19
Flashing lights	16	4.47
Highway signals, wigwags, or bells	4	1.12
Watchman	6	1.67
Crossbucks	87	24.30
STOP signs	137	38.27
Other signs	5	1.40
No signs or signals	88	24.58
Total	358	100.00

Source: Federal Railroad Administration Safety Data Website (safetydata.fra.dot.gov/officeofsafety).

As with public crossings, the first consideration for improving private crossings is closure. Adjacent crossings should be evaluated to determine if they can be used instead of the private crossing. Every effort to close the crossing should be made.

An example of a private crossing program is the Private Crossing Safety Initiative developed by the North Carolina Department of Transportation (NCDOT). This initiative evaluates private crossings, although private grade crossings are typically under

Table 51. Collisions at Private Crossings by Roadway User, 2004

Type of vehicle	Collisions		Fatalities		Injuries	
	Number	Percent	Number	Percent	Number	Percent
Automobile	102	29.57	12	34.28	28	23.33
Truck	128	37.10	15	42.86	62	51.67
Tractor-trailer	107	31.01	3	8.57	30	25.00
Bus	0	0.00	0	0.00	0	0.00
Pedestrian	6	1.74	4	11.43	0	0.00
Other*	2	0.58	1	2.86	0	0.00
Total	345	100.00	35	100.00	120	100.00

* “Other” usually refers to farm equipment.

Source: Federal Railroad Administration Safety Data Website (safetydata.fra.dot.gov/officeofsafety).

Figure 68. Typical Private Crossing Sign

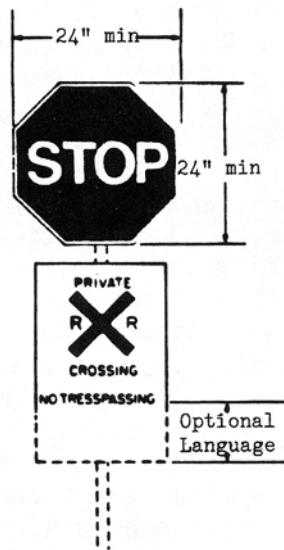

Source: Railroad-Highway Grade Crossing Handbook, Second Edition. Washington, DC: U.S. Department of Transportation, Federal Highway Administration, 1986.

the jurisdiction of railroad companies. NCDOT is proceeding with crossing safety improvements along the Charlotte, North Carolina to Raleigh, North Carolina “Sealed Corridor” by closing private crossings where feasible and protecting the private crossings that will remain open with crossbucks, automatic flashers and gates, signals, and locking gates. These improvements will be identified through a systematic analysis conducted on all 46 private crossings within the NC Railroad Company corridor operated by Norfolk Southern and CSX Transportation. There is no legal precedent for public agency involvement in crossing safety enhancements, consolidation, or closure of private crossings on a corridor basis. Therefore, this initiative will require cooperation among the state, railroads, and all property owners who utilize private crossings within the corridor.

Another example of a state policy regarding private crossings recently adopted by West Virginia is included in Appendix J.

If the private crossing is determined to be essential to the private landowner, the crossing should be marked with some type of sign. Controversy exists over whether the marking should be identical to public crossings, so that the motorist is presented with uniform traffic control devices, or whether the marking should be distinct to notify the motorist that the crossing is private and that use without permission is trespassing. No national guidelines exist; however, it seems reasonable that the crossing should be

marked so that it is identified as a private crossing. Supplemental crossbucks or STOP signs might also be installed.

Some private crossings have sufficient train and roadway traffic volume that they require active traffic control devices. Considerations for the installation of these devices are the same as for public crossings, as discussed in Chapter IV. Federal funds and, often, state funds cannot be used for the installation of traffic control improvements at private crossings. The railroad and the landowner usually come to an agreement regarding the financing of the devices. In some cases, if the landowner is required to pay for the installation of the crossing and its traffic control devices, the landowner might reevaluate the need for the crossing.

B. Short-Line Railroads

There are numerous short-line railroads, and the number is growing due to federal deregulation. Short-line railroads are typically Class III railroads, as defined by the Federal Railroad Administration (FRA). Class III railroads include all switching and terminal companies and all line-haul railroads that have annual gross revenue of less than \$10 million, in 1978 constant dollars. Many of these short-line railroads provide switching and terminal services for the larger Class I and II railroad companies. Many short-line railroads belong to the American Short Line and Regional Railroad Association (ASLRRA). Headquartered in Washington, DC, ASLRRA provides liaison with governmental agencies, serves as a source for information and assistance, and provides other benefits to short-line railroads.

Some short-line railroads took over the operation of a single line that a larger railroad abandoned for economic reasons. Short-line railroads often require assistance with regard to highway-rail grade crossings because of their limited manpower and financial resources. These small railroads are often unable to seek out federal and state funds for improving crossings, yet safety at their crossings is just as important as at any other crossing.

Ownership of these smaller lines comes from a variety of investment sources, such as state or local governments, port authorities, other short lines, private entrepreneurs, and shipper groups. Many new owners of short lines are keenly aware of the costs of line acquisition, track and rolling stock rehabilitation, and other operational expenditures. However, new operators may be unaware of the substantial

expenditures needed for rebuilding crossing surfaces, renewing older traffic control systems, and maintaining them.

Costs associated with crossings may constitute a considerable portion of the limited annual maintenance-of-way budgets of short-line railroads. The general condition of the abandoned plant, as acquired by the new owner, is usually far from best. The track condition may be adequate, requiring relatively little annual expense in comparison to other plant needs. Therefore, as annual track maintenance costs are reduced, crossing expenditures may constitute as much as 50 percent of the annual maintenance-of-way budget over the next 10 years. This, of course, depends on factors such as the location of the line in relation to population centers and intensities of heavy truck traffic.

On short-line railroads, there is often a lack of specialized personnel for handling the many crossing responsibilities, such as the continuing maintenance of highly complex electronic crossing traffic control equipment.

Although rail traffic on the smaller lines generally tends to be sparse as well as slow, these crossings, in comparison to larger railroads, are not necessarily safer. National statistics indicate that the vast majority of crossing collisions occur at relatively low train speeds.

Adequate planning is essential to ensure the proper formation of new short-line railroads and to improve their survival as a necessary part of the U.S. transportation system. When dealing with short-line railroads, state agencies should be aware of their limited experience, skills, and knowledge. State agencies can assist by informing short-line railroads of the requirements for improving crossings on their system and direct them to other appropriate sources of information. State agencies should ensure that the short-line railroads operating in their state are included in the lines of communication regarding crossings. Short-line railroads also should be encouraged to participate in other crossing safety programs, such as Operation Lifesaver.

C. Light-Rail Lines and Issues

1. Motor Vehicle Turning Treatments

Motor vehicles that make illegal turns in front of approaching light-rail vehicles (LRV) account for the greatest percentage of total collisions for most light-rail

train (LRT) systems. Moreover, when such a collision occurs, the door of the motor vehicle is the only protection between the driver/passenger and the LRV, which makes turning collisions one of the most severe types of collisions between motor vehicles and LRVs. Traffic control devices that regulate turns are critical to LRT and general traffic safety.

Where turning traffic crosses a non-gated, semi-exclusive LRT alignment and is controlled by left- or right-turn arrow signal indications, Transit Cooperative Research Program (TCRP) Report 17 recommends that the LRT agency install an LRV-activated, flashing, internally illuminated warning sign displaying the front view LRV symbol (W10-7) when the LRV approaches.¹³² When such a sign is used, the turn arrow signal indication serves as the primary regulatory control device and the flashing, internally illuminated warning sign supplements it, warning motorists of the increased risk associated with violating the turn arrow signal indication.

At the June 2005 meeting of the National Committee on Uniform Traffic Control Devices (NCUTCD), the council approved modifications to Part 10, which would allow use of the W10-7 active warning train icon sign as a supplemental device for any traffic crossing an LRT trackway, regardless of whether it is turning or continuing through.

Where turning traffic crosses a non-gated, semi-exclusive LRT alignment and is controlled by a STOP sign or signal without a turn arrow (such as a permissive left or right turn), TCRP Report 17 recommends that an LRV-activated, internally illuminated “No Left/Right Turn” (R3-2/R3-1) symbol sign be provided to restrict left or right turns when an LRV is approaching (see Figure 69). Because these signs would serve as the primary control devices regulating turning movements, TCRP Report 17 recommends that two signs be provided for each parallel approach. The LRV-activated, internally illuminated sign displaying the legend NO LEFT/RIGHT TURN may be used as an alternate to the active, internally illuminated symbol sign.

Table 53 summarizes the recommended practices for the active, internally illuminated “No Left/Right Turn” symbol sign (regulatory) and the flashing, internally illuminated “Train Approaching” sign (warning) for median or side-running LRT alignments where parallel traffic is allowed to proceed during LRV movements.

¹³² Korve, Hans W., Jose I. Farran, Douglas M. Mansel, et al. *Integration of Light Rail Transit into City Streets*. Washington, DC: Transit Cooperative Research (TCRP) Report 17, Transportation Research Board (TRB), 1996.

Figure 69. No Turns Internally Illuminated Signs

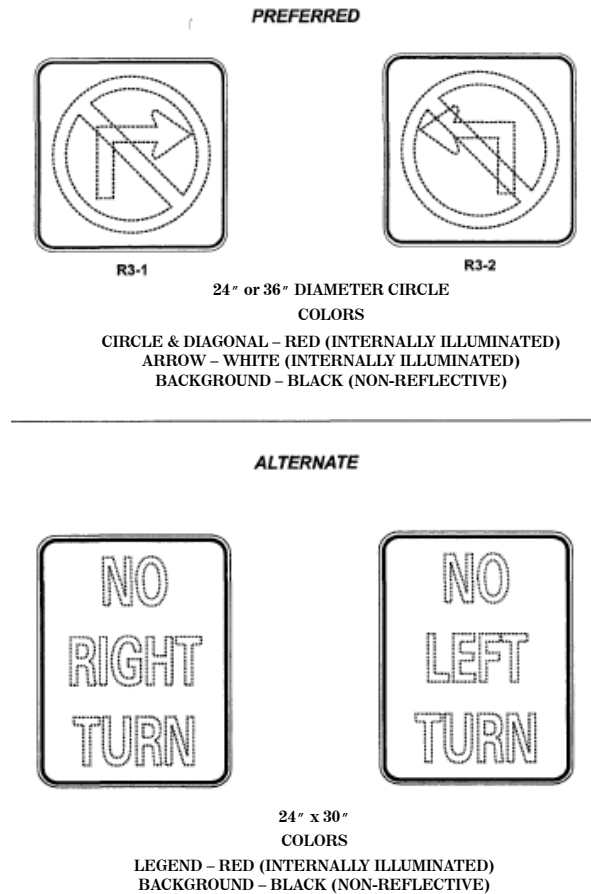

Source: Korve, Hans W., Jose I. Farran, Douglas M. Mansel, et al. Integration of Light Rail Transit into City Streets. Washington, DC: Transit Cooperative Research Report 17, Transportation Research Board, 1996.

Note that the action of the NCUTCD council at the June 2005 meeting would broaden the use of the train icon sign (W10-7) to include any location where traffic crosses an LRT trackway.

2. Use of Crossbuck Sign with LRT

When Part 10 was added to the *Manual on Uniform Traffic Control Devices* (MUTCD), text was included that could be interpreted to mean that the crossbuck sign (R15-1) is required at every LRT crossing, regardless of the presence of any other traffic control devices. However, it is not customary practice to install the crossbuck sign at LRT grade crossings where the tracks are within a roadway and the primary traffic control device is a traffic signal. At the June 2005 meeting of NCUTCD, the council approved clarifying language indicating that the use of a crossbuck sign is optional for semi-exclusive or mixed alignments where other traffic control devices are present.

3. Pedestrian Crossing Treatments

Although collisions between LRVs and pedestrians occur less often than collisions between LRVs and motor vehicles, they are more severe. Furthermore, pedestrians are often not completely alert to their surroundings at all times, and LRVs, when operating in a street environment, are nearly silent. For these reasons, appropriate pedestrian crossing control systems are critical for LRT safety.

Flashing light signal. At non-gated, unsignalized, pedestrian-only crossings of semi-exclusive LRT rights

Table 53. Use of Active Internally Illuminated Signs for Parallel Traffic Turning Across LRT Tracks

Alignment type	Intersection traffic control device	"No Left/Right Turn" sign	Train icon sign for left/right turns ^a
Semi-exclusive gated	Stop ^c	Recommended	May
	Traffic signal without arrow ^d	Recommended ^b	May
	Traffic signal with arrow ^e	Not recommended	May
Semi-exclusive non-gated	Stop ^c	Recommended	May
	Traffic signal without arrow ^d	Recommended ^b	May
	Traffic signal with arrow ^e	Not recommended	Recommended

^a Left-turn signs are for median and side-aligned LRT alignments; right-turn signs are for side-aligned LRT alignments only.

^b Alternatively, an all-red phase for motor vehicles and pedestrians may be used in combination with "No Turn On Red" (R10-11a) signs.

^c "Stop" refers to a STOP sign-controlled intersection.

^d "Without arrow" refers to a signalized intersection at which the turning traffic has no red arrow displayed when an LRV is approaching but has either a steady green ball, a red ball, or a flashing red ball displayed.

^e "With arrow" refers to a signalized intersection at which the turning traffic has a red arrow displayed when an LRV is approaching. When a turn arrow traffic signal indication is used, TCRP Report 17 recommends that an exclusive turn lane be provided.

Source: Korve, Hans W., Jose I. Farran, Douglas M. Mansel, et al. Integration of Light Rail Transit into City Streets. Washington, DC: Transit Cooperative Research Report 17, Transportation Research Board, 1996.

of way, a flashing light signal assembly (see Figure 70, option A), where LRT operates two ways on one track or on a double track, serves as the primary warning device. That is, when the red lenses of the flashing light signal are flashing alternately and the audible device of the flashing light signal is active, the pedestrian is required to remain clear of the tracks (Uniform Vehicle Code, Section 11-513).

Figure 70. Placement of Flashing Light Signal Assemblies

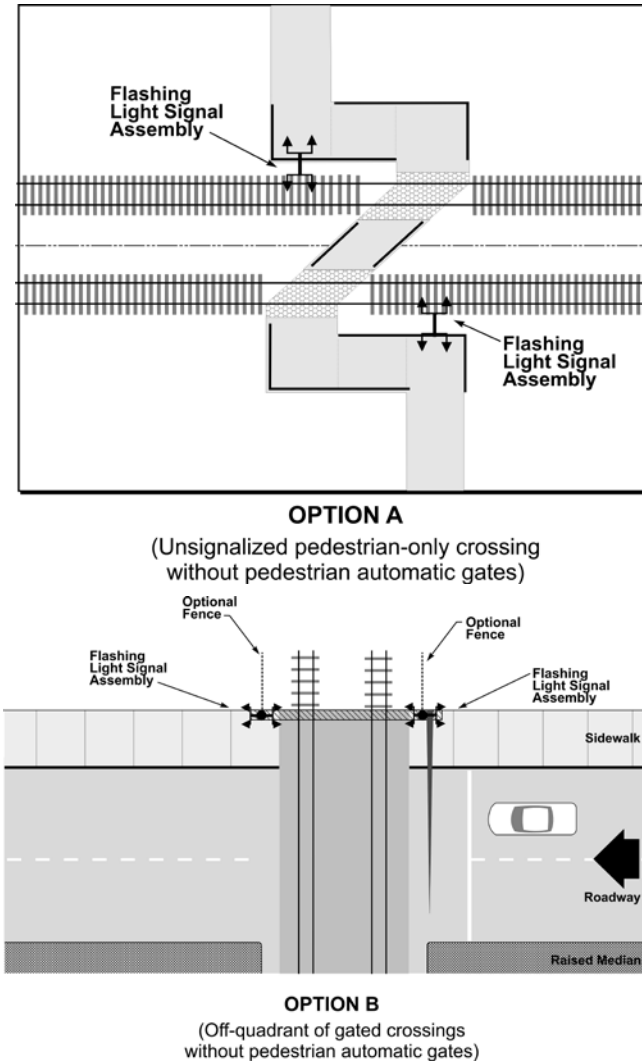

Source: Korve, Hans W., Jose I. Farran, Douglas M. Mansel, et al. Integration of Light Rail Transit into City Streets. Washington, DC: Transit Cooperative Research Report 17, Transportation Research Board, 1996.

At motor vehicle, gated LRT crossings without pedestrian gates, TCRP Report 17 recommends that the flashing light signal assembly (Figure 70, option B) be used in the two quadrants without vehicle automatic gates. According to this recommendation, these signal devices should be installed adjacent to the pedestrian crossing facing out from the tracks. The signal

assembly includes a standard crossbuck sign (R15-1) and, where there is more than one track, an auxiliary inverted T-shaped sign indicating the number of tracks (R15-2).

“Second Train Coming” sign. An LRV-activated, internally illuminated matrix sign displaying the pedestrian crossing configuration with one or two (or three or four, etc.) LRVs passing may be used to alert pedestrians to the direction from which one or multiple LRVs are approaching the crossing, especially at locations where pedestrian traffic is heavy (such as LRT stations). An example of the active matrix sign is shown in Figure 71.

Figure 71. Example Active Matrix Train Approaching Sign

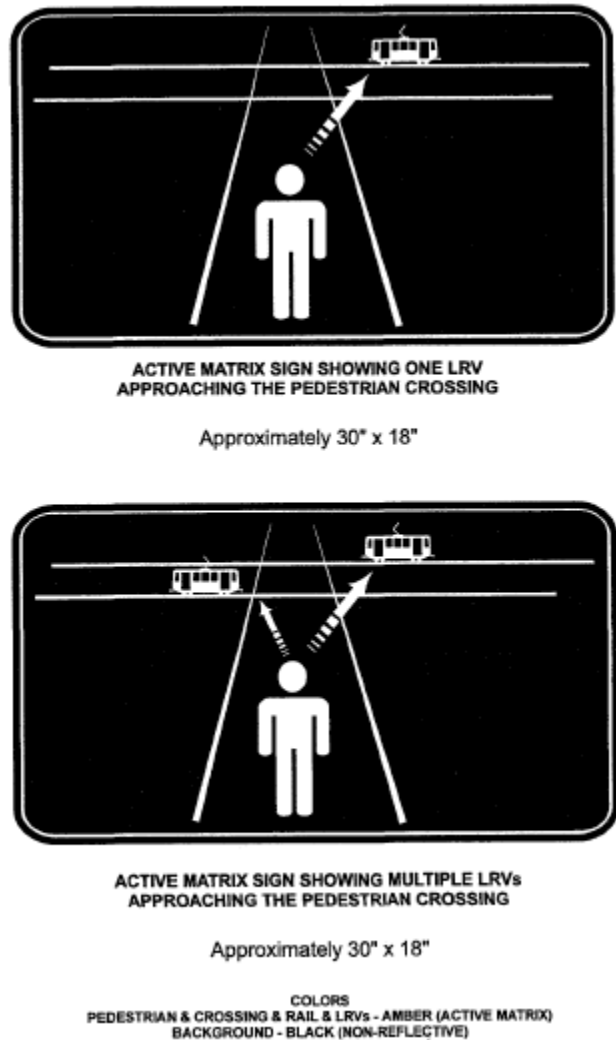

Source: Korve, Hans W., Jose I. Farran, Douglas M. Mansel, et al. Integration of Light Rail Transit into City Streets. Washington, DC: Transit Cooperative Research Report 17, Transportation Research Board, 1996.

Alternatively, an LRV-activated, internally illuminated flashing sign with the legend SECOND TRAIN—LOOK LEFT/RIGHT may be used to alert the pedestrian that a second LRV is approaching the crossing from a direction that the pedestrian might not be expecting (see Figure 72). This sign warns pedestrians that although one LRV has passed through the crossing, a second LRV is approaching, and that other warning devices (such as flashing light signal assembly and bell) will remain active until the second LRV has cleared the crossing.

Figure 72. Example Second Train Internally Illuminated Signs

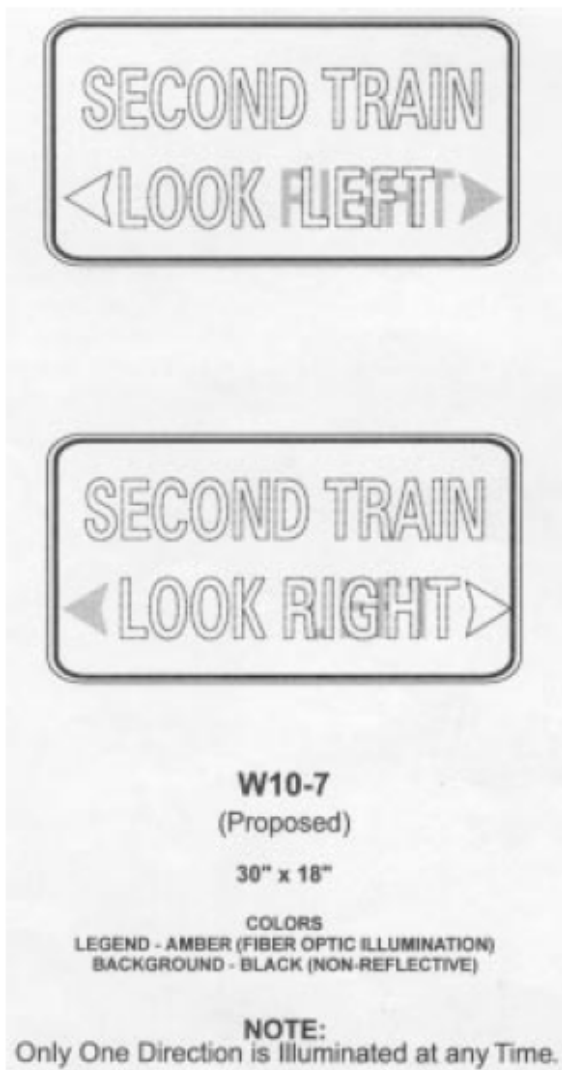

Source: Korve, Hans W., Jose I. Farran, Douglas M. Mansel, et al. Integration of Light Rail Transit into City Streets. Washington, DC: Transit Cooperative Research Report 17, Transportation Research Board, 1996.

TCRP Report 17 recommends that the “Second Train—Look Left/Right” sign be placed on the far side of the

crossing (and on the near side as well if necessary for pedestrian visibility), especially when the crossing is located near an LRT station, track junction, and/or multiple track alignment (more than two tracks). When this sign is activated, only one direction, left or right, is illuminated at any time. Furthermore, only one arrow (to the left of “Look” or the right of “Right”) is illuminated at any time—the one that points in the direction of the second approaching LRV. If two LRVs are very closely spaced so that they will pass through the pedestrian crossing almost simultaneously, TCRP Report 17 recommends that this sign not be activated because there would be no opportunity for pedestrians to cross between the successive LRVs, and pedestrians should look in both directions.

These warning signs should be mounted as close as possible to the minimum height above the ground set by MUTCD, Part II, Section 2A-23. If they are mounted higher than the minimum height specified (6 or 7 feet), pedestrians often will not see or will simply ignore the signs. They should be mounted lower than the minimum height only if pedestrians cannot injure themselves by colliding with the signs.

Dynamic envelope markings. TCRP Report 17 recommends that the LRV’s dynamic envelope be delineated at pedestrian crossings in semi-exclusive rights of way and along entire semi-exclusive and non-exclusive corridors. According to this recommendation, contrasting pavement texture should be used to identify an LRV’s dynamic envelope through a pedestrian crossing. A solid 4-inch-wide line may be used as an alternative. Tactile warning strips approved by the Americans with Disabilities Act (ADA) can be considered a contrasting pavement texture, and their requirement may supersede the use of painted striping or other contrasting pavement texture. TCRP Report 17 recommends that in an LRT/pedestrian mall, the dynamic envelope be delineated in its entirety. As shown in Figure 73, the Sacramento, California LRT system uses ADA-approved tactile warning strips to delineate the dynamic envelope along the K Street LRT/pedestrian mall.

In addition to pedestrian signals (including flashing light signals), warning signs, and dynamic envelope markings, several pedestrian barrier systems have proven effective in reducing collisions between LRVs and pedestrians. These barriers, and the transit systems or railroads where they have been successfully installed, include the following:

Curbside pedestrian barriers. Between intersections in shared rights of way, TCRP Report 17 recommends that curbside barriers (landscaping,

Figure 73. ADA Dynamic Envelope Delineation in Sacramento, California



Source: Korve, Hans W., Jose I. Farran, Douglas M. Mansel, et al. Integration of Light Rail Transit into City Streets. Washington, DC: Transit Cooperative Research Report 17, Transportation Research Board, 1996.

bedstead barriers, fences, and/or bollards and chains) be provided along side-aligned LRT operations where LRVs operate two ways on a one-way street (contra-flow operations). They may also be provided for one-way side-aligned LRT operations for normal flow alignments. As shown in Figure 74, the San Diego, California LRT system uses bollards along C Street to warn pedestrians of the LRT tracks.

Pedestrian automatic gates. Pedestrian automatic gates are the same as standard automatic crossing gates except that the gate arms are shorter. When they are activated by an approaching LRV, the automatic gates are used to physically prevent pedestrians from crossing the LRT tracks. TCRP Report 17 recommends that this type of gate be used in areas where pedestrian risk of a collision with an LRV is medium to high (for example, whenever LRV stopping sight distance is inadequate).

The preferred method is to provide pedestrian automatic gates in all four quadrants, installed as follows: Where right-of-way conditions permit, TCRP Report 17 recommends that the vehicle automatic gate be located behind the sidewalk (on the side that is away from the curb), so that the arm will extend across the sidewalk, blocking the pedestrian way (see Figure 75, option A). Longer and lighter gate arms make this installation feasible. However, experience suggests a maximum gate arm length of 38 feet for practical operation and maintenance. At crossings requiring the gate arm to be longer than 38 feet, a second automatic gate shall be placed in the roadway median. (Note that the effective coverage is less than 38 feet due to set-back requirements and the size of the gate mechanism.)

Figure 74. San Diego, California Curbside Pedestrian Barriers

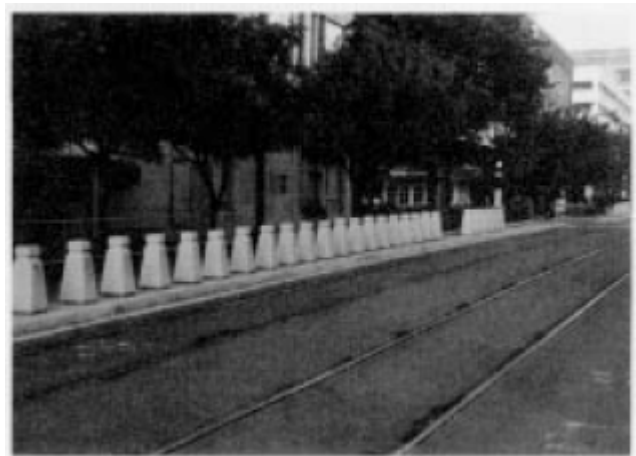

Source: Korve, Hans W., Jose I. Farran, Douglas M. Mansel, et al. Integration of Light Rail Transit into City Streets. Washington, DC: Transit Cooperative Research Report 17, Transportation Research Board, 1996.

To provide four-quadrant protection, TCRP Report 17 recommends that two single-unit pedestrian automatic gates also be installed behind the sidewalk, across the tracks, opposite the vehicle automatic gates. This vehicle and pedestrian automatic gate configuration is shown in Figure 76 and is preferred because it keeps the sidewalk clear for pedestrians and minimizes roadside hazards for motorists.

Figure 75. Placement of Pedestrian Automatic Gates

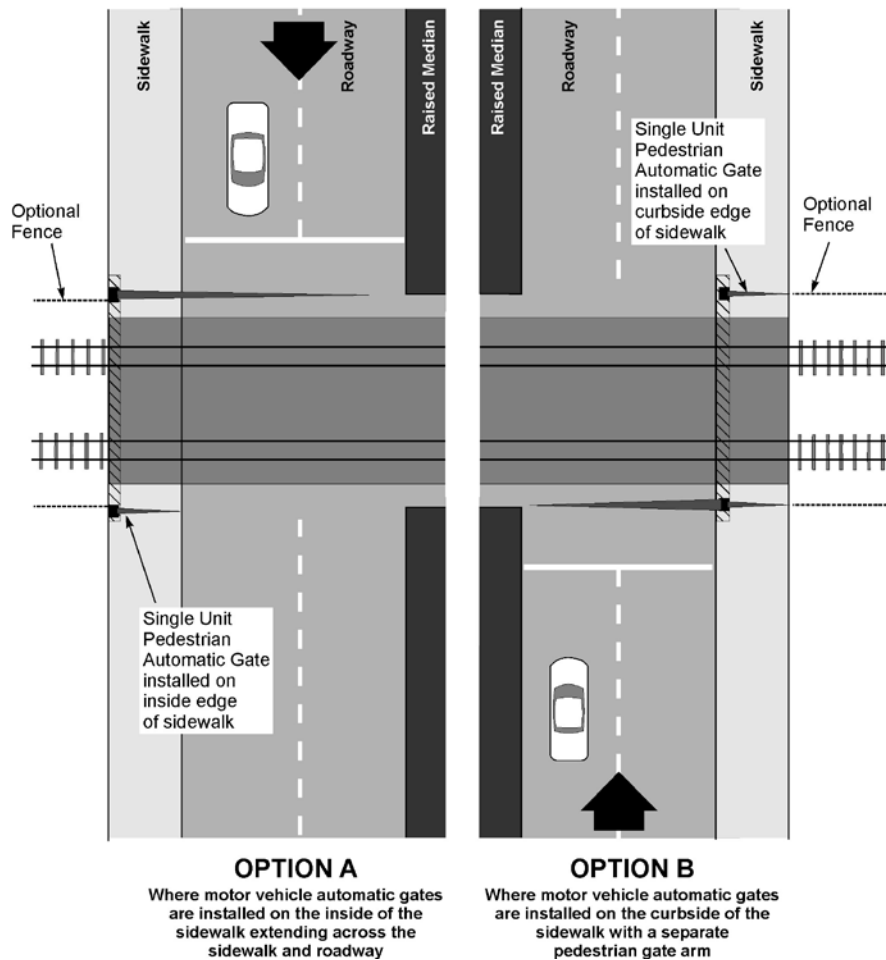

Source: Korve, Hans W., Jose I. Farran, Douglas M. Mansel, et al. Integration of Light Rail Transit into City Streets. Washington, DC: Transit Cooperative Research Report 17, Transportation Research Board, 1996.

As an alternative, the pedestrian automatic gate may share the same assembly with a vehicle automatic gate (see Figure 75, option B). In this case, TCRP Report 17 recommends that a separate driving mechanism be provided for the pedestrian automatic gate so that a failure of the pedestrian automatic gate will not affect vehicle automatic gate operations. According to this recommendation, to provide four-quadrant protection, a single-unit pedestrian automatic gate should also be installed on the curbside of the sidewalk, across the tracks, opposite the vehicle automatic gate and pedestrian automatic gate assembly. This vehicle and pedestrian automatic gate configuration is shown in Figure 76.

The possibility of trapping pedestrians in the LRT right of way when four-quadrant pedestrian gates

are installed should be minimized. TCRP Report 17 recommends establishing clearly marked pedestrian safety zones and escape paths within the crossing.

Swing gates. The swing gate (sometimes used in conjunction with flashing lights and bells) alerts pedestrians to the LRT tracks that are to be crossed and forces them to pause, thus deterring them from running freely across the tracks without unduly restricting their exit from the LRT right of way. The swing gate requires pedestrians to pull the gate to enter the crossing and push the gate to exit the protected track area; therefore, a pedestrian cannot physically cross the track area without pulling and opening the gate. TCRP Report 17 recommends that the gates be designed to return to the closed position after the pedestrian has passed, as shown in Figure 77.

Figure 76. Pedestrian Automatic Gate Examples



Source: Korve, Hans W., Jose I. Farran, Douglas M. Mansel, et al. *Integration of Light Rail Transit into City Streets*. Washington, DC: Transit Cooperative Research Report 17, Transportation Research Board, 1996.

Swing gates may be used at pedestrian-only crossings, on sidewalks, and near stations (especially if the station is a transfer point with moderate pedestrian volumes) where pedestrian risk of a collision with an LRV is medium to high (for example, where there is moderate stopping sight distance, moderate pedestrian volume, etc.). These gates may be used at pedestrian crossings of either single-track (one- or two-way LRT operations) or double-track alignments.

TCRP Report 17 recommends that the use of swing gates be supplemented with proper signing mounted on or near the gates. Such signing includes the “Light Rail Transit Crossing/Look Both Ways” (W10-5a) sign (where LRVs operate two ways) or LRV-activated, internally illuminated warning signs and/or flashing light signal assemblies. Where LRVs operate in a single-track, two-way alignment, TCRP Report

17 recommends that an LRV-activated, internally illuminated matrix sign or active, internally illuminated sign with the legend TRAIN—LOOK LEFT/RIGHT be installed to supplement swing gates.

Bedstead barriers. The bedstead concept may be used in tight urban spaces where there is no fenced-in right of way, such as a pedestrian grade crossing at a street intersection (see Figure 78). The barricades are placed in an offset (maze-like) manner that requires pedestrians moving across the LRT tracks to navigate the passageway through the barriers. TCRP Report 17 recommends that they be designed and installed to turn pedestrians toward the approaching LRV before they cross each track, forcing them to look in the direction of oncoming LRVs. According to this recommendation, the barriers should also be used to delineate the pedestrian queuing area on both sides of the track area. Bollards and chains accomplish the same effect as bedstead barriers.

Bedstead barriers may be used for crossings where pedestrians are likely to run unimpeded across the tracks, such as stations or transfer points, particularly where pedestrian risk of a collision with an LRV is low to medium (for example, where there is excellent to moderate stopping sight distance, double tracking, low pedestrian volume, etc.). TCRP Report 17 recommends that the barriers be used in conjunction with flashing lights, pedestrian signals, and appropriate signing. Bedstead barriers may also be used in conjunction with automatic gates in high-risk areas.

TCRP Report 17 recommends that bedstead barriers not be used when LRVs operate in both directions on a single track because pedestrians may be looking the wrong way in some instances. Pedestrians also look in the wrong direction during LRV reverse-running situations; however, because reverse running is performed at lower speeds, this should not be a deterrent to this channeling approach.

Z-crossing channelization. The Z-crossing controls movements of pedestrians approaching LRT tracks. Its design and installation turn pedestrians toward the approaching LRV before they cross each track, forcing them to look in the direction of oncoming LRVs (see Figure 79).

Z-crossing channelization may be used at crossings where pedestrians are likely to run unimpeded across the tracks, such as isolated, midblock, pedestrian-only crossings, particularly where pedestrian risk of a collision with an LRV is low to medium (for example, where there is excellent stopping sight distance, double tracking, low pedestrian volume, etc.).

Figure 77. Pedestrian Swing Gate Examples



Source: Korve, Hans W., Jose I. Farran, Douglas M. Mansel, et al. Integration of Light Rail Transit into City Streets. Washington, DC: Transit Cooperative Research Report 17, Transportation Research Board, 1996.

Figure 78. Bedstead Barrier Application



Source: Korve, Hans W., Jose I. Farran, Douglas M. Mansel, et al. Integration of Light Rail Transit into City Streets. Washington, DC: Transit Cooperative Research Report 17, Transportation Research Board, 1996.

Z-crossings used with pedestrian signals create a safer environment for pedestrians than Z-crossings used alone. This type of channelization device may also be used in conjunction with automatic gates in high-risk areas. TCRP Report 17 recommends that the Z-crossing not be used when LRVs operate in both directions on a single track because pedestrians may be looking the wrong way in some instances. Pedestrians also look in the wrong direction during LRV reverse-running situations; however, because reverse running is performed at lower speeds, this should not be a deterrent to this channeling approach.

Figure 79. San Diego, California Pedestrian Z-Crossing



Source: Korve, Hans W., Jose I. Farran, Douglas M. Mansel, et al. Integration of Light Rail Transit into City Streets. Washington, DC: Transit Cooperative Research Report 17, Transportation Research Board, 1996.

Combined pedestrian treatments. The pedestrian crossing/barrier systems described may be used in combination, as shown in Figure 80, depending on pedestrian risk of a collision with an LRV at the crossing. Moreover, pedestrian safety and queuing areas should always be provided and clearly marked.

4. Solutions to Observed Problems

Table 54 presents some possible solutions to common problems at LRV crossings. This material was presented in TCRP Report 69, which addresses LRT operation at speeds greater than 35 miles per hour (mph).

Figure 80. Illustrative Pedestrian Treatment

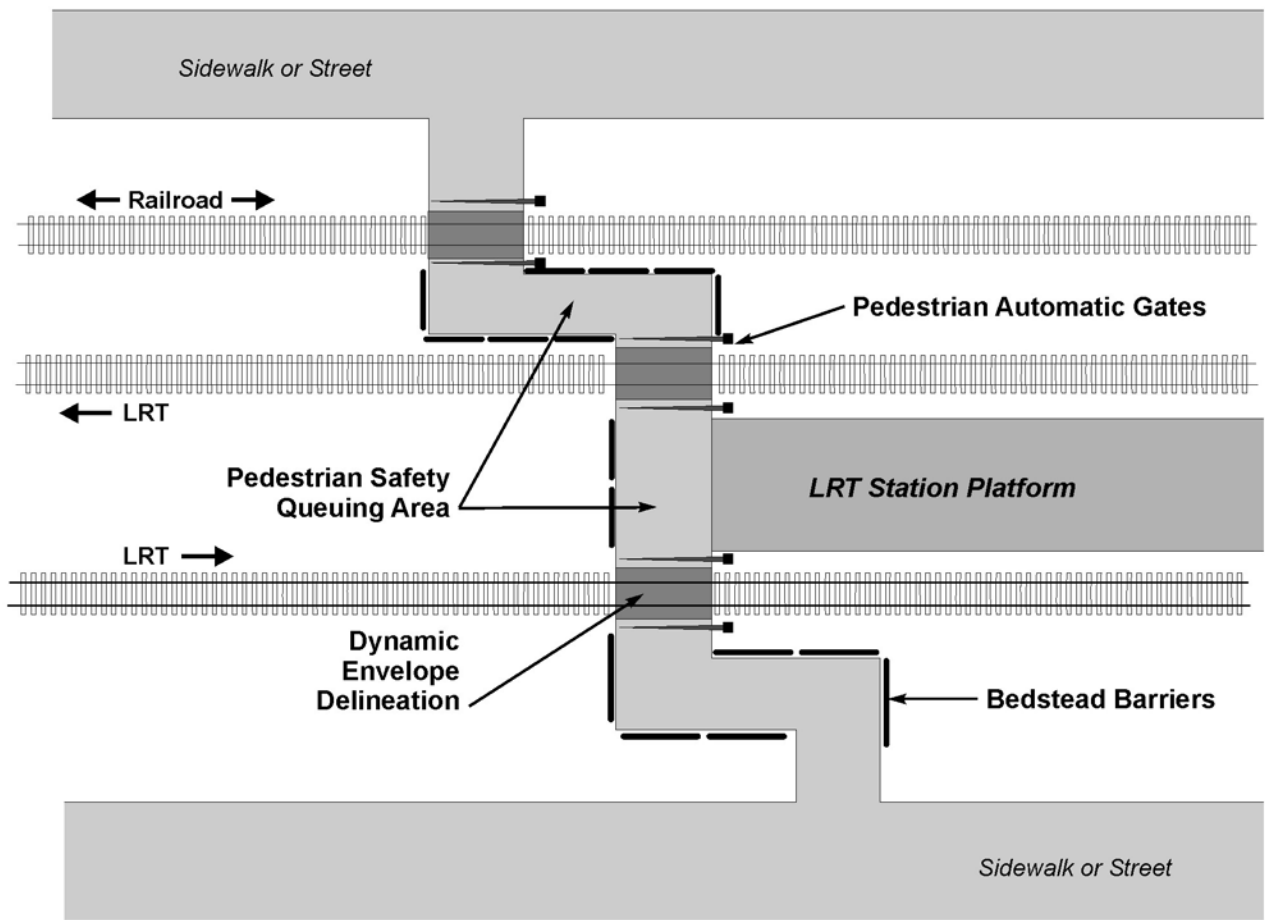

Source: Korve, Hans W., Jose I. Farran, Douglas M. Mansel, et al. Integration of Light Rail Transit into City Streets. Washington, DC: Transit Cooperative Research Report 17, Transportation Research Board, 1996.

Table 54. Possible Solutions to Observed Problems

Issue	Possible solution
<p>1. System design</p> <ul style="list-style-type: none"> Vehicles driving around closed automatic gates. 	<p>Install raised medians with barrier curbs. Install channelization devices (traffic dots or flexible posts). Install longer automatic gate arms. Photo enforcement. Four-quadrant gates. For parallel traffic, install protected signal indications or LRV-activated “No Right/Left Turn” signs (R3-1, 2). For parallel traffic, install turn automatic gates.</p>
<ul style="list-style-type: none"> LRV operator cannot visually confirm if gates are working. 	<p>Install gate indication signals or in-cab wireless video link. Install and monitor at a central control facility a Supervisory Control and Data Acquisition system.</p>
<ul style="list-style-type: none"> Slow trains share tracks/crossings with LRVs and near-side LRT station stops. 	<p>Constant warning time. Use gate delay timers.</p>
<ul style="list-style-type: none"> Motorist disregard for regulatory signs at LRT crossings and grade crossing warning devices. 	<p>Avoid excessive use of signs. Photo enforcement.</p>
<ul style="list-style-type: none"> Motor vehicles queue back across LRT tracks from a nearby intersection controlled by STOP signs (R1-1). 	<p>Allow free flow (no STOP sign) off the tracks or signalize intersection and interconnect with grade crossing.</p>
<ul style="list-style-type: none"> Sight distance limitations at LRT crossings. 	<p>Maximize sight distance by limiting potential obstructions to 1.1 meter (3.5 feet) in height within about 30 to 60 meters (100 to 200 feet) of the LRT crossing (measured parallel to the tracks back from the crossing).</p>
<ul style="list-style-type: none"> Motor vehicles queue across LRT tracks from downstream obstruction. 	<p>Install “Do Not Stop on Tracks” sign. Install “Keep Clear” zone striping. Install queue cutter signal.</p>
<ul style="list-style-type: none"> Automatic gate and traffic signal interconnect malfunctions. 	<p>Install plaque at crossing with 1-800 phone number and crossing name and/or identification number.</p>
<p>2. System operations</p> <ul style="list-style-type: none"> Freight line converted to or shared with light-rail transit. 	<p>For new LRT systems, initially operate LRVs slower, then increase speed over time.</p>
<ul style="list-style-type: none"> Collisions occur when second LRV approaches pedestrian crossing. 	<p>When practical, first LRV slows/stops in pedestrian crossing, blocking pedestrian access until second, opposite direction LRV enters crossing.</p>
<ul style="list-style-type: none"> Motorists disregard grade crossing warning devices. 	<p>Adequately maintain LRT crossing hardware (routinely align flashing light signals) and reduce device “clutter.”</p>
<ul style="list-style-type: none"> Emergency preparedness. 	<p>Training of staff and emergency response teams (fire, police).</p>
<p>3. Traffic signal placement and operation</p> <ul style="list-style-type: none"> Motorists confused about apparently conflicting flashing light signal and traffic signal indicators. 	<p>Use traffic signals on the near side of the LRT crossing (pre-signals) with programmable visibility or louvered traffic signal heads for far-side intersection control. Avoid using cantilevered flashing light signals with cantilevered traffic signals.</p>
<ul style="list-style-type: none"> Track clearance phasing. 	<p>Detect LRVs early to allow termination of conflicting movements (pedestrians).</p>
<ul style="list-style-type: none"> Excessive queuing near LRT crossings. 	<p>Use queue prevention strategies, pre-signals.</p>

(continued)

Issue	Possible solution
<ul style="list-style-type: none"> Turning vehicles hesitate during track clearance interval. 	Provide protected signal phases for through and turning motor vehicles.
<ul style="list-style-type: none"> Vehicles queue back from closed gates into intersection. 	Control turning traffic toward the crossing.
<ul style="list-style-type: none"> LRT crosses two approaches to a signalized intersection (diagonal crossing). 	Detect LRVs early enough to clear both roadway approaches and/or use pre-signals or queue cutter signals. Delay the lowering of the gates that control vehicles departing the common intersection.
<ul style="list-style-type: none"> Motorists confused about gates starting to go up and then lowering for a second, opposite direction LRV. 	Detect LRVs early enough to avoid gate pumping (also allows for a nearby traffic signal controller to respond to a second LRV preemption). At near-side station locations, keep gates raised until LRV is ready to depart.
<ul style="list-style-type: none"> LRT versus emergency vehicle preemption. 	At higher-speed LRT crossings (speeds greater than 55 km/hr. (35 mph)), LRVs receive first priority and emergency vehicles second priority.
<ul style="list-style-type: none"> Turning motorists violate red protected left-turn indication due to excessive delay. 	Recover from preemption to phase that was preempted.
<ul style="list-style-type: none"> With leading left-turn phasing, motorists violate red protected left-turn arrow during preemption. 	Switch from leading left-turn phasing to lagging left-turn phasing.
<p>4. Automatic gate placement</p> <ul style="list-style-type: none"> At angled crossings or for turning traffic, gates descend on top of or behind motor vehicles. 	Install gates parallel to LRT tracks. Install advanced traffic signal to control turning traffic.
<p>5. Pedestrian control</p>	
<ul style="list-style-type: none"> Limited sight distance at pedestrian crossing. 	Install pedestrian automatic gates (with flashing light signals and bells (or alternative audible device)).
<ul style="list-style-type: none"> Pedestrians dart across LRT tracks without looking. 	Install warning signs. Install swing gates.
<ul style="list-style-type: none"> Pedestrians fail to look both ways before crossing tracks. 	Channel pedestrians (Z-crossings). Paint LRT directional arrow between tracks.
<ul style="list-style-type: none"> Pedestrians ignore warning signs. 	Mount signs closer to average eye level for pedestrians. Install active pedestrian warning devices. Provide education and enforcement.
<ul style="list-style-type: none"> Pedestrians stand too close to tracks as train approaches crossing. 	Install pedestrian stop bar with tactile warning outside of the dynamic envelope.
<ul style="list-style-type: none"> Pedestrians and bicyclists routinely cross the LRT tracks behind the automatic gate mechanism while it is activated. 	Install positive control behind the sidewalk (if present) or roadway shoulder.

Source: Korve, Hans W., Brent D. Ogden, Joaquín T. Siques, Douglas M. Mansel, et al. Light Rail Service: Pedestrian and Vehicular Safety. Washington, DC: Transit Cooperative Research Project Report 69, Transportation Research Board, 2001.

D. High-Speed Rail Corridors

Special consideration must be given to highway-rail grade crossings on high-speed passenger train routes. The potential for a catastrophic collision injuring many passengers demands special attention. This not only includes dedicated routes with speeds over 100 mph but also other passenger routes over which trains may operate at speeds higher than freight trains.

Variations in warning time may occur with high-speed passenger trains at crossings equipped with active traffic control devices. Because of the wide variation in train speeds (passenger trains versus freight trains), train detection circuitry should be designed to provide the appropriate advance warning for all trains.

High-speed passenger trains present additional problems at crossings with only passive traffic control devices. Safe sight distance along the track from a stopped position must be much greater for a faster train. The sight distance along the track from the highway approach must also be greater unless vehicle speed is reduced. In addition, it is difficult to judge the speed of an oncoming train.

Private crossings are a major concern for high-speed passenger trains. These crossings usually have only passive traffic control devices and often consist of narrow, unimproved, or gravel roads with limited visibility along the railroad tracks.

Special attention should be given to crossings on high-speed rail passenger routes. Some states utilize priority indices that include a factor for train speed or potential dangers to large numbers of people. In this manner, crossings with high-speed passenger trains are likely to rank higher than other crossings and, thus, be selected for crossing improvements.

Another method for improving crossings on high-speed passenger routes is to utilize the systems approach. As discussed in Chapter III, the systems approach involves the inspection and evaluation of safety and operations at crossings within a specified system, such as along a high-speed rail corridor.

It is desirable that all crossings located on high-speed rail corridors either be closed, grade separated, or equipped with automatic gates. The train detection circuitry should provide constant warning time. Where feasible, other site improvements may be necessary at these crossings. Sight distance should be improved by clearing all unnecessary signs, parking, and buildings

from each quadrant. Vegetation should be periodically cut back or removed. Improvements in the geometries of the crossing should be made to provide the best braking and acceleration distances for vehicles.

Education of the public is an important element for the improvement of safety and operations at crossings on high-speed rail corridors. This can be accomplished with publicity campaigns and public service announcements, as described in the next chapter. Public education might also alleviate some fears of high-speed trains and provide for better railroad-community relations. State agencies and railroads should cooperatively undertake this.

Special signing might also be employed at these crossings to remind the public that the crossings are used by high-speed trains. No national standard exists for such signing; however, the signing should be in conformance with the guidelines provided in MUTCD.

E. Special Vehicles, Pedestrians, Motorcycles, and Bicycles

Highway-rail grade crossings are designed and controlled to accommodate the vehicles that use them. The vast majority of these vehicles consist of automobiles, buses, and all types of trucks. Generally speaking, improvements to a crossing with these users in mind will be adequate for any other special users, such as trucks carrying hazardous materials, long-length trucks, school buses, motorcycles, bicycles, and pedestrians. However, these users have unique characteristics and special needs that should be considered. Chapter II discussed some of these characteristics. This chapter will present some design and control considerations.

1. Trucks with Hazardous Material Cargo

Collisions involving trucks with hazardous material cargo are potentially the most dangerous because they can have deleterious effects over a wide area. Consequently, all crossings used by these vehicles should be considered for improvements and, in turn, these improvements should consider the special needs of these vehicles.

Drawing on the National Transportation Safety Board's study of train collisions involving these vehicles and their subsequent recommendations, several suggestions are provided to address this concern:

- Trucks carrying bulk hazardous material should use routes that have grade separations or active control devices. Where routes that have crossings with only passive control devices are near terminals, the crossings should be considered for upgrading to active control.
- Ensure that active warning devices are activated with enough “warning time” (activation in advance of the arrival of a train) so that trucks have the available distance required for stopping. Also, for vehicles stopped at the crossing when signals are not operating, adequate warning time should be provided for clearance of tracks by loaded trucks before the arrival of a train.
- If feasible, where there is an intersection in close proximity to the crossing, increase the storage space (defined as the “clear storage distance” in MUTCD) between the tracks and the intersecting highway. If on a direct route to a truck terminal, also consider giving right of way to the critical movement through control measures.
- Promote a program of education and enforcement to reduce the frequency of hazardous driving and alert the driver of potential danger. Driver training and education programs such as Operation Lifesaver should be expanded to include a specific program that addresses the problems.

At crossings where a significant volume of trucks is required to stop, consideration should be given to providing a pull-out lane. These auxiliary lanes allow trucks to come to a stop and then to cross and clear the tracks without conflicting with other traffic. Hence, they minimize the likelihood of rear-end collisions or other vehicle-vehicle collisions. They would be appropriate for two-lane highways or for high-speed multilane highways.

2. Long and Heavily Laden Trucks

As discussed in Chapter II, large trucks have particular problems at crossings because of their length and performance characteristics. Longer clearance times are required for longer vehicles and those slow to accelerate. Also, longer braking distances become necessary when trucks are heavily laden, thus reducing their effective braking capability.

As truck sizes, configurations, and weights have increased over time, it is critical to address currently allowable large vehicles (such as the interstate semitrailer truck—WB-62 or WB-65), where such

vehicles may be expected to utilize a highway-rail grade crossing on a regular basis. Consequently, when considering improvements, the designer should be aware of and design for the amount and type of current and expected truck traffic. Areas that should be focused upon include:

- Longer sight distances.
- Placement of advance warning signs.
- Warning time for signals.
- Approach and departure grades.
- Storage area between tracks and nearby highway intersection.

3. Buses

Because buses carry many passengers and have performance characteristics similar to large trucks, these vehicles also need special consideration. Many of the measures suggested for trucks with hazardous material apply to buses. Railroad-highway grade crossings should be taken into consideration when planning school bus routes.

Potentially hazardous crossings, such as those with limited sight distance or horizontal or vertical alignment issues, should be avoided if possible. Crossings along school bus routes should be evaluated by the appropriate highway and railroad personnel to identify potentially dangerous crossings and the need for improvements. Drivers should be instructed on safe crossing procedures and should be made aware of expected railroad operations, such as the speed and frequency of train movements.

4. Motorcycles and Bicycles

Although motorcycles and bicycles typically travel at different speeds, these two-wheeled vehicles can experience the same problem at crossings. Depending on the angle and type of crossing, a cyclist may lose control of the vehicle if the wheel becomes trapped in the flangeway. The surface materials and the flangeway width and depth must be evaluated. The more the crossing deviates from the ideal 90-degree crossing, the greater the potential for a cycle wheel to be trapped in the flangeway. If the crossing angle is less than 45 degrees, consideration should be given to widening the bikeway to allow sufficient width to cross the tracks at a safer angle.

Other than smooth surface treatments, there are no special controls for these special vehicles. However, if a bicycle trail crosses tracks at grade, the bicyclist should be warned of this with suitable markings and signs, such as those shown in Figure 81.

Figure 81. Recommended Sign and Marking Treatment for Bicycle Crossing

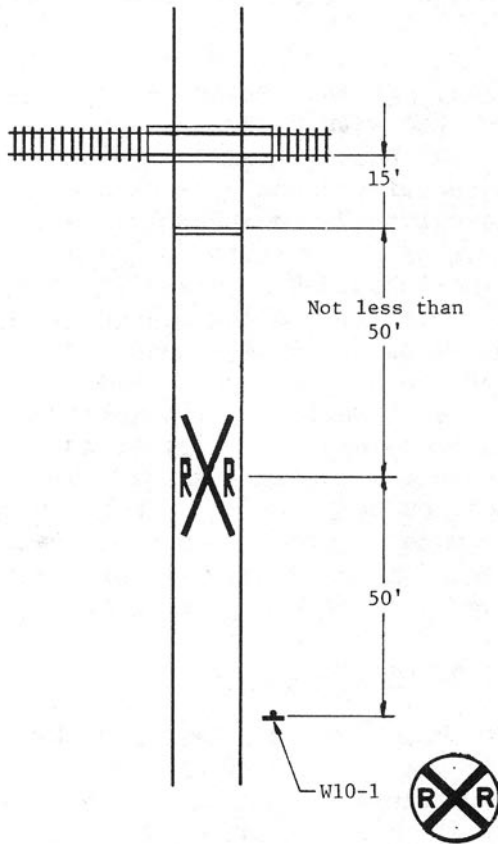

Source: Railroad-Highway Grade Crossing Handbook, Second Edition. Washington, DC: U.S. Department of Transportation, Federal Highway Administration, 1986.

Pedestrians. The safety of pedestrians crossing railroads is the most difficult to control because of the relative ease with which pedestrians can go under or around lowered gates. Pedestrians typically seek the shortest path and, therefore, may not always cross the tracks at the highway or designated pedestrian crossing.

Because of the variety of factors that may contribute to pedestrian hazards, detailed studies are necessary to determine the most effective measures to provide for pedestrian safety at specific locations.

A variety of preventive measures can be employed. (Refer also to Chapter IX, Part C, "Light-Rail Transit" for safety measures identified in reports issued by TCRP.) As of the preparation of this handbook, the Railroad Technical Committee of NCUTCD has established a pedestrian task force charged with expanding the provisions for pedestrian traffic control devices.

Fencing. Fencing that encloses the right of way may be used to restrict access. A 6- to 8-foot-high chain link fencing, sometimes topped with barbed wire, is commonly used. Fencing is usually placed on both sides of the right of way, but it can be an effective deterrent to indiscriminate crossing if placed on only one side. The main objection to fencing is its cost, which may be in excess of \$100,000 per mile for construction. Furthermore, it does not bar entrances at crossings. Alternatively, a single 4-foot fence, placed parallel to the track and across a pedestrian crossing route, might be a lower-priced and somewhat effective deterrent. Fencing is commonly used between multiple tracks at commuter stations. Maintenance is an additional cost.

Separated crossings. To prevent vandalism of continuous fencing, pedestrian crossings might be provided over or under the track(s) at reasonable intervals. Pedestrian grade separations are expensive and should be designed to maximize pedestrian use. If a structure is built, it should be accessible, and pedestrians should be directed to it through the use of barriers, fencing, or signs.

Improved signing. An example whereby pedestrian and trespasser safety near railroads can be enhanced through improved signing concerns electrified rail lines, in particular, their catenaries (the overhead wires used to carry energy to electric locomotives). The electrical current is so great that shocks can result without actual contact with the wire. Warning signs along electrified railroads can reduce collisions. These signs should provide both symbolic representation (such as a lightning bolt) and the warning legend.

Safety education. The education of actual and potential trespassers can reduce the incidence of right-of-way collisions. Individual railroads as well as the Association of American Railroads and Operation Lifesaver have conducted active railroad safety programs for many years through schools.

Surveillance and enforcement. No form of pedestrian safety program can be effective without some level of surveillance and enforcement. At present, trespassing is generally considered a misdemeanor, and law enforcement officials are often indisposed to prosecute. A more effective procedure for some forms of railroad trespassing would be to treat it like jaywalking and issue a citation with automatic imposition of a fine if a hearing were waived. Such a procedure would impose some burden on the trespasser who otherwise might only be reprimanded.

ADA. ADA (1990) gives civil rights protections to individuals with disabilities similar to those provided to individuals on the basis of race, color, sex, national origin, age, and religion. It guarantees equal opportunity for individuals with disabilities in public accommodations, employment, transportation, state and local government services, and telecommunications.

ADA standards for accessible design were published as Appendix A to the Title III regulations by the U.S. Department of Justice (28 CFR Part 36, revised July 1, 1994). These standards address many geometric features pertaining to pedestrian facilities, including:

- Minimum widths and clearances.
- Accessible routes and pedestrian pathways.
- Curb ramps and ramps.
- Protruding objects.

These standards are available from the ADA home page on the Department of Justice Website.¹³³

F. Low-Cost Active Devices

A recent study considered the applicability of lower-cost alternative technologies to provide active warning at crossings that presently lack such devices.¹³⁴

The research identifies the component costs for traditional active grade crossing systems and explains what influences these costs. Alternative practices and technologies are discussed from national and international perspectives to explain the limitations and possibilities of implementing lower-cost active grade crossing systems in the United States. An array of pertinent assessment criteria for low-cost active grade crossing systems was developed to assess the relative merits of each technology. The criteria were incorporated into a decision-making framework and evaluation tool that helped assess the appropriateness of these systems for further evaluation.

The report notes that technological advances over the past decade suggest that there has to be a low-cost way to signalize some of the thousands of passive grade crossings that exist in the United States and notes that redundancy and fail-safe elements may comprise 25 to 35 percent of the total system cost.

¹³³ U.S. Department of Justice Americans with Disabilities Act Website (www.usdoj.gov/crt/ada).

¹³⁴ Roop, Stephen S., Craig E. Roco, Leslie E. Olson, and Richard A. Zimmer. *An Analysis of Low-Cost Active Warning Devices For Highway-Rail Grade Crossings*. Washington, DC: Texas Transportation Institute, National Cooperative Highway Research Program, NAS 188 HR 3-76B, March 2005.

The study evaluated 12 technologies, including:

- Geophone.
- Fiber optic (rail).
- Fiber optic (buried).
- Video imagery.
- Radar (speed).
- Radar (speed and distance).
- Acoustic.
- Pressure sensor.
- Magnetic anomaly.
- Infrared.
- Laser.

These technologies were ranked by applying a set of evaluation criteria to a multi-criteria analysis process that assessed the relative merits of each low-cost warning device, including factors ranging from safety-related measures to measures of reliability, maintainability, and ease of installation. This analysis used a hierarchical formulation of broadly defined project goals tied to specific objectives, with each objective quantified by a performance measure, to add consistency and structure to the selection of favorable alternatives.

Evaluation criteria included:

- Enhanced safety.
- Reduced system cost.
- Reliability.
- Installability.
- Maintainability.
- Compatibility.

Identified cost groupings included:

- Ultra-low cost: less than \$2,000.
- Low cost: \$2,000–\$8,000.
- Moderate cost: greater than \$8,000.

To prevent the emphasis from being placed strictly on seeking the lowest-cost active warning systems, the analysis grouped similarly priced systems to evaluate their merits relative to other important features. Results from the analysis indicated that future research should focus on improving the safety of the acoustic and radar off-right-of-way systems. Specifically, it was recommended that they should be evaluated for consistency of performance and the potential to calibrate them to operate with minimal risk exposure. It was also concluded that the risks associated with implementing acoustic and radar systems should be quantified so that the net benefit of increasing the number of active warning systems through the use of these technologies can be determined.

The final report for the analysis documents all aspects of the evaluation, including the use of a multi-criteria analysis framework, and also discusses trade-offs between reliability, cost, and safety reduction, which are inherent to deployment of low-cost technologies. At the time this handbook went to press, work was underway on the installation of prototype devices for the purpose of field evaluation.

G. ITS Applications

ITS has some applications at railroad crossings that affect traffic signal preemption. Under normal operating conditions, the train has the right of way at crossings, and the crossings are managed to maximize safety while minimizing delay to roadway traffic. This involves the coordination of railroad active safety devices with highway traffic signals as well as the dissemination of crossing status information to aid in route planning.

1. ITS National Architecture and User Service 30

The Federal Highway Administration (FHWA), in conjunction with FRA, has developed “User Service 30” to describe the ITS applications that relate to the highway-rail grade crossing. These ITS applications have been defined in the National ITS Architecture, which is a framework for developing integrated transportation systems. The National ITS Architecture defines a set of “subsystems,” “terminators,” and “architecture flows” that describe the transfer of information between ITS systems.

Subsystems are the building blocks of the National ITS Architecture that perform the ITS functions identified in 33 user services (which include the highway-rail grade crossing user service). Terminators are systems that interface with the ITS systems. Architecture flows are the definition of the information that is passed between subsystems or between subsystems and terminators. In the context of the National ITS Architecture, highway-rail grade crossing functions are identified with three interfaces:

- Roadway subsystem and the wayside equipment terminator.
- Traffic management subsystem (TMS) and the rail operations terminator.
- Highway-rail intersection data, traffic management to roadway.

Roadway subsystem and the wayside equipment terminator. The roadway subsystem represents ITS field equipment, including traffic signal controllers. The wayside equipment terminator represents train interface equipment (usually maintained and operated by the railroad and (usually) physically located at or near a grade crossing. The roadway subsystem interface with the railroad wayside equipment will provide crossing status and blockage notification to wayside equipment and, conversely, real-time information about the approach (actual or predicted) of a train to the roadway subsystem. The interface operates as follows:

- The roadway subsystem sends the real-time crossing status to the wayside equipment. This includes a confirmation that the grade crossing is closed (gates are down) and that trains may proceed at full authorized speed.
- The roadway subsystem also sends a real-time indication of intersection blockage. This message would be used to provide the information needed by the wayside equipment to alert the train to reduce speed or stop.
- The wayside equipment provides a real-time indication of its operational status via the track status flow. This would alert the roadside equipment to possible failures or problems in the wayside equipment. The track status flow also includes the simple binary indication of a train approaching, which is currently used when traffic signal controller units are interconnected with the wayside equipment.
- In future implementations, the wayside equipment would provide expected time of arrival and length of closure via an arriving train information flow.

TMS and the rail operations terminator. The interface between the rail operations terminator and TMS provides for the exchange of management or near real-time data between these two key functions.

- The rail operations function will send information to the TMS to support forecasting of crossing closures. This includes train schedules and crossing maintenance schedules. In addition, the rail operations function will send to the TMS information about rail incidents that may impact vehicle traffic. This latter information would be in near real time; other schedule information would be provided on a periodic basis (such as daily).
- The TMS would notify the rail operations function in near real time about equipment failure, intersection blockage, or other incident

information (such as a nearby hazardous material spill). The TMS would also send information about planned maintenance activities occurring at or near the crossing that would impact the railroad right of way.

Roadway subsystem and TMS. The addition of highway-rail intersection (HRI) functions to the National ITS Architecture added several communications flows between the roadway subsystem and the TMS.

- The roadway subsystem determines the status of the crossing and transmits this to the TMS. This status includes several components: information about the crossing itself; information about the traffic in the neighborhood of the crossing; information about the expected closure time and duration (obtained from the wayside equipment); and information that should be displayed via variable message signing or beacons (for in-vehicle signing). In addition, an intersection blockage notification flow is included to provide an indication if a blockage at the crossing exists.
- The TMS will communicate with the roadway subsystem with two types of crossing-related messages: control messages (the HRI control data flow) sent directly to the crossing equipment (such as the intelligent intersection controller, variable message signing, etc.), and a status request flow (the HRI request flow). The HRI control data flow can also include rail advisory information obtained from the rail operations terminator and forwarded by the TMS.¹³⁵

2. Standard 1570

The Institute of Electrical and Electronics Engineers (IEEE) empanelled a working group that developed IEEE Standard 1570, “Standard for the Interface Between the Rail Subsystem and the Highway Subsystem at a Highway Rail Intersection.” This standard was developed to coordinate information transfer between the two with emphasis on digital data communication and to enable interoperability among the various types of equipment. A high-level diagram of this interface is shown in Figure 82.

¹³⁵ *Preemption of Traffic Signals Near Railroad Crossings*, Appendix D (ITS Applications). Washington, DC: Institute of Transportation Engineers, January 2004; along with User Service 30 information.

3. Survey of Recent ITS Initiatives

To increase awareness and research efforts in the area of highway-rail grade crossing safety, FRA tasked the John A. Volpe National Transportation Systems Center to review past projects with similar goals and conduct a demonstration program that will utilize aspects of both ITS and positive train control at an HRI to increase the safety of the crossing.

The majority of the first part of the effort in the survey consisted of a literature search for relevant past projects that used portions of either ITS or positive train control capabilities. Several of these projects have continued operating and are providing beneficial safety aspects. Variable message signs are the primary enabling technology of many of the projects reviewed and continue to be used with great success. In-vehicle warning systems have played a much more limited role due to the use of technologies that have not been standardized and, for the most part, these systems have been dismantled.

Selected initiatives are described below.

Minnesota in-vehicle warning system. The Minnesota Department of Transportation, Minnesota Mining and Manufacturing Company (3M), and Dynamic Vehicle Safety Systems (DVSS) developed and demonstrated an in-vehicle warning system. The system was designed to alert drivers of potentially dangerous highway-rail grade crossing situations. Due to the finite number of vehicles and drivers, school buses were chosen as the test vehicle group.

Five highway-rail grade crossings were equipped with warning transmitters, and 29 school buses were equipped with receivers. The transmitters continuously broadcast a radio signal via antenna. The warning device broadcast the presence of the train when the train activated the conventional highway-rail grade crossing safety feature. Vehicles in the vicinity automatically were informed of their distance to the crossing and whether or not a train was present. Four of the five crossings were also capable of broadcasting the direction the train was traveling.

The warning was displayed to the driver both audibly and visually. The audio signal output automatically adjusted in relation to the ambient noise in the vehicle to help guarantee the driver was alerted. The system was also designed only to activate and alert when the direction of the vehicle would take it through the crossing.

Figure 82. Highway Rail Intersection Interface Overview

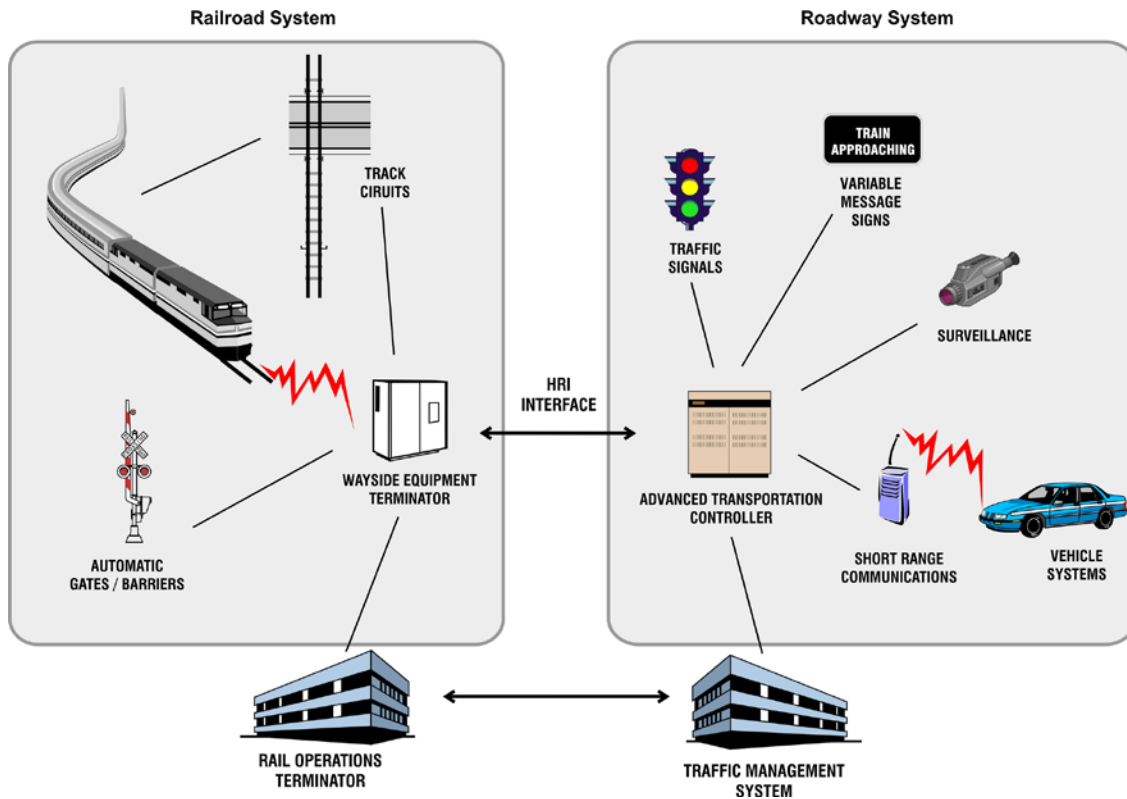

Source: "The National Architecture for ITS," U.S. Department of Transportation.

Figure 83. In-Vehicle Display

The system used a traditional two-quadrant gate system with track circuitry for train detection. Radio transmitters were fixed to the crossbucks to provide the warning to the in-vehicle system. Within the vehicle, a unique type of in-vehicle display (shown in Figure 83) was developed to provide the warning to the driver. The in-vehicle equipment also consisted of a device to receive the radio transmissions from the crossbuck-mounted transmitter.

Because the system was installed on a small sampling of crossings and buses and because the test period was short, no significant statistical difference could be calculated to indicate the impact of the in-vehicle warning system on driver behavior. The primary determination of the effectiveness of the system was the behavioral characteristics of the bus drivers and their own opinions culled from surveys. Locomotive engineers were also queried as to the effectiveness of the system.

There was a general acceptance and perception of value by drivers and railroad personnel. The drivers also favored the crossings that were capable of broadcasting the train direction. The majority of drivers felt the system should be installed permanently.



Source: Minnesota Department of Transportation.

Upon completion of the evaluation, all components, including in-vehicle devices and trackside components, were removed from service. Currently, there is no plan to resume operation of this system.

Long Island Railroad second-train changeable message sign. In an effort to improve safety, the Long Island Railroad (LIRR) installed second-train changeable message signs (CMS) at the Stewart Avenue highway-rail grade crossing along the LIRR mainline in Bethpage, New York. The system became operational in November 2002 with the primary intent of improving pedestrian awareness and safety. The Stewart Avenue highway-rail grade crossing is listed as one of the 10 most dangerous crossings in the state of New York, having witnessed multiple fatalities, one as recent as 1999, and many pedestrian incidents.

The system LIRR chose for this application incorporates text and graphic CMS with audible warnings and strobe lights. The audible warning consists of a voice broadcast via public announcement speakers mounted adjacent to the CMS, audibly repeating the message shown in text on the CMS. All of the warning devices are mounted on custom cantilever support arms that had to be designed and installed specifically for this application at all four quadrants of the highway-rail grade crossing.

In addition to the warning devices, LIRR installed event recorders that connect to the central office at the Stewart Avenue highway-rail grade crossing as part of the new central monitoring system. Currently, the system is not designed for fail-safe operation. The system allows LIRR to determine if activation from the track circuitry was received; however, LIRR currently has no way of determining if the system is functioning correctly or functioning at all. LIRR is considering implementing video surveillance to enhance the system.

Evaluation of the LIRR second-train warning system has not been conducted and no true data have been collected to determine the effect of the system on safety of the Stewart Avenue highway-rail grade crossing. One issue that has been discussed is pedestrian confusion as a result of the CMS not being activated. Currently, the system is activated only during a second-train event. Crossing users can misinterpret non-activation of the system during single-train arrival events to mean that it is safe to circumvent the deployed gates. This has not caused any collisions, but further assessment of the situation is required.

The only maintenance cost associated with the system is periodic testing, which is currently performed monthly in addition to the scheduled crossing maintenance.

Alameda Corridor-East integrated roadway/rail interface system. As part of a larger grade crossing improvement program, the Alameda Corridor-East Jump Start Safety Improvements Program, the integrated roadway/rail interface system (IR/RIS) is being installed on several HRIs within this corridor. The corridor encompasses a distance of 35 miles through the San Gabriel Valley between East Los Angeles and Pomona, California. The Jump Start Program itself is targeting 34 crossings in this area for improvement in safety. These improvements will help eliminate gate drive-arounds, improve pedestrian crossings, and improve warning lights and traffic signals.

The IR/RIS system is focusing on reducing both traffic delays and large queues, which build up near the highway-rail grade crossings. It is also hoped that driver frustration due to delays will be reduced. The demonstration project is located in the Pomona area, which experiences traffic delays due to high rail traffic that sometimes consists of long through freight trains, some of which pause at times at the highway-rail grade crossings. There is also commuter rail traffic at peak times, which occurs simultaneously with peak automobile traffic, causing further congestion.

The demonstration project will detect trains 5 miles from the crossings and predict their arrival at the highway-rail grade crossings. This information will be used to determine if traffic signals in the area should be adjusted. There will also be CMS in the area that can inform motorists and pedestrians of the situation. Rerouting of traffic may also take place because three grade-separated crossings are located in the area and will allow for alternative routes.

Because the existing train detection subsystem is not adequate for the prediction of train arrival times, a new system will be installed independent of the existing system. The new system will use magnetometers.

Initial testing of the system has been successful and has proven the accuracy of train detection, speed, and length. Full demonstration testing will continue.

Minnesota low-cost active warning for low-volume HRI warning project. The Minnesota Department of Transportation, Twin Cities and Western Railroad, C3 Trans Systems Limited Liability Company, and SRF Consulting Group Incorporated, along with FRA and FHWA, have teamed to develop and test a low-cost active warning system for low-volume highway-rail grade crossings as an alternative to traditional and expensive active highway-rail grade crossing warning devices. The main objectives of the

project are to determine whether the low-cost active train warning system can improve safety and function as well as traditional railroad grade crossing signals. The project is also looking to determine whether the low-cost system's addition of flashers or CMS on advance rail warning signs provides additional benefits. The project goal is to have a system cost that is approximately 10 percent of traditional grade crossing warning systems.

This ITS system consists of the addition of solar panel battery-powered light-emitting diode flashers to traditional highway-rail grade crossing crossbuck signs and solar panel battery-powered amber flashers to traditional advanced warning signs. Activation of the flashers is provided by low-power radio communications from approaching locomotives. Power is supplied via a battery bank that has integrated solar panels. An in-cab display notifies the locomotive engineer of the warning device status.

There is built-in logic with a self-update capability and fault reporting. In the event that a failure does occur, within 5 minutes of that failure, the system notifies the central office of the event via cellular telephone. The low-cost warning device also sends a signal via low-power radio communications link to the locomotive cab. Inside the cab, there is a display with a series of three lights: red, yellow, and green. This display will notify the locomotive crew of a failure in time to stop the train.

Active mode testing of the system using several locomotives and more than 30 equipped highway-rail grade crossings was completed in the summer of 2004. A final report for the project is available on the Minnesota Department of Transportation Website.¹³⁶

4. Proposed Demonstration Scenarios

Based on the survey of past projects and pending development of technology such as dedicated short-range communication (DSRC), the Volpe Center has proposed to FRA several alternative demonstrations that could provide increased safety at highway-rail grade crossings.

One scenario involves the utilization of either a global positioning satellite (GPS)-based product or a wireless radio system to notify an approaching roadway vehicle operator that he or she is nearing a

highway-rail grade crossing. The system would provide this advanced warning indication within the vehicle. Because most vehicles in the United States do not contain in-vehicle displays, such as those in Japan, the use of a personal digital assistant (PDA) device would seem more appropriate for the test. The option to use a vehicle with a built-in display could also be pursued because their availability is growing, although most are available in higher-cost vehicles.

Using wireless communications, a highway-rail grade crossing would be outfitted with a localized transmitter that broadcasts its presence to approaching vehicles. The vehicles will be outfitted with a PDA or other device that can receive the radio broadcast transmitted by the highway-rail grade crossing. Several options for communications are possible, with the latest DSRC 5.9GHz band protocol being the most promising. A new standard is being formulated for this protocol and includes specific channels for ITS safety applications. Another option is the 802.11b protocol known as Wi-Fi, but because it was not developed for moving objects, it would most likely require modification.

With the GPS-based approach, navigation software could be updated with the locations of all documented highway-rail grade crossings in the United States. Currently, several navigation products for PDAs could be used. Modifications of these products would probably be required because they do not contain the location of all highway-rail grade crossings. When the navigation software determines the vehicle approaching the highway-rail grade crossing, a warning will be issued through a visual and/or an aural alert.

Another option is to investigate the use of the Data Radio System (DRS) protocol. Many off-the-shelf in-dash radios today are capable of receiving DRS transmissions. These systems interrupt the AM/FM radio broadcast or CD/tape-playing features of the in-dash unit and display a message to the vehicle occupants. The feasibility of using a localized transmitter at a highway-rail grade crossing would need to be investigated.

The second scenario will utilize one or more CMS interfaced to a train control and/or detection system to provide advanced warning of a train(s) approaching motorists and pedestrians. Ideally, the train control system will be enabled with positive train control to allow for warnings of trains at all speeds. Using such an advanced technology would allow for multiple types of warnings, such as train approaching crossing, second train approaching, estimated delay time, etc. The system could be demonstrated with audio and text

136 "Low-Cost Highway-Rail Intersection Active Warning System Field Operational Test Evaluation Report." Minnesota Department of Transportation, Office of Traffic, Security and Operations. URS Corporation and TranSmart Technologies, Inc. December 2005 (www.dot.state.mn.us/guidestar/projects/hris.html).

messaging. The capabilities would be limited by the information supplied by the train control system and/or the track circuits. Because not all railroad lines will be equipped with positive train control, new methods of train detection could provide accurate and reliable signals to warn of approaching trains. Alternative train detection equipment is another enabling technology that will assist in implementing some of the advanced ITS concepts.

Other ideas with potential applications at highway-rail grade crossings revolve around the use of video monitoring of highway-rail grade crossings where large volumes of hazardous cargo are transported through the area. In-cab video monitoring could also be used to relay blocked highway-rail grade crossings. Also, weather monitoring could become part of a highway rail-grade crossing system by transmitting weather conditions to passing trains, warning of potential washouts or fog conditions ahead.

Human factors analysis will play a role in any demonstration. How individuals react to the various warnings and messages will need to be analyzed during the demonstration and will provide useful feedback on the effectiveness of the system.¹³⁷

¹³⁷ “Review of Intelligent Transportation Systems Applications at Highway-Rail Intersections In The United States.”

H. References

Federal Highway Administration Survey of Region and Division Offices, unpublished, 1984.

Manual on Uniform Traffic Control Devices, 2003 Edition. Washington, DC: Federal Highway Administration, 2003.

Rail-Highway Crossing Accident/Incident and Inventory Bulletin. Washington, DC: Federal Railroad Administration, published annually.

Railroad/Highway Grade Crossing Accidents Involving Trucks Transporting Bulk Hazardous Materials: A Special Study. Washington, DC: National Transportation Safety Board, Report NTSB-HZM-81-2, September 1981.

Railroad-Highway Safety, Part II: Recommendations for Resolving the Problem, A Report to Congress. Washington, DC: U.S. Department of Transportation, August 1972.

Sonefeld, Otto F. “Crossing Costs Can Endanger New Short Line Viability.” *Railway Track and Structures*, May 1983.

Supporting Programs



Programs other than engineering support and are essential to highway-rail grade crossing safety and operations. These programs include public education about crossing components and driver responsibilities, enforcement of the traffic laws governing movement over crossings, and research on the various components of crossings.

A. Driver Education and Enforcement

As discussed in Chapter II, motorists have major responsibilities for their safe movement over crossings. Because railroad trains cannot stop as quickly as motor vehicles, drivers must take precaution to avoid collisions with trains. However, many motorists are unaware of these responsibilities and do not know the meaning of crossing traffic control devices. Educating motorists on safe driving actions, train operations, and crossing traffic control devices can minimize crossing collisions.

Since the early part of this century, railroads have endeavored to educate the public about crossings. On their own initiative, many railroads developed materials and distributed them to the news media, law enforcement agencies, schools, and civic clubs. They made presentations at schools, civic club meetings, and other gatherings.

Today, these educational programs have evolved into a nationwide program called Operation Lifesaver, an international, non-profit education and awareness program dedicated to ending collisions, fatalities, and injuries at highway-rail grade crossings and on railroad rights of way. To accomplish its mission, Operation Lifesaver trains speakers to provide a safety message to their communities and promotes the 3 Es: education, enforcement, and engineering.

- Through education, Operation Lifesaver strives to increase public awareness about dangers around the rails. The program seeks to educate both drivers and pedestrians to make safe decisions at crossings and around railroad tracks.
- The organization works with enforcement agencies around the United States in support of traffic laws related to crossing signs and property laws related to trespassing.
- Operation Lifesaver encourages continued engineering research and innovation to improve the safety of railroad crossings.

Operation Lifesaver began in Idaho in 1972, when the national average of collisions at highway-rail grade crossings exceeded 12,000 annually. A six-week public awareness campaign called Operation Lifesaver was sponsored by the office of Governor Cecil Andrus, the Idaho Peace Officers, and Union Pacific Railroad as a one-time, one-state initiative.

During the campaign's first year, Idaho's crossing-related fatalities dropped by 43 percent. The next year, the Operation Lifesaver campaign spread to Nebraska, where the collision rate was reduced by 26 percent. Kansas and Georgia experienced similar success the following year.

Between 1978 and 1986, while Operation Lifesaver operated under the auspices of the National Safety Council, all 49 continental states started independent Operation Lifesaver programs. In 1986, the national program was released from the National Safety Council and incorporated as a national, non-profit, 501(c)(3) educational organization. The founding sponsors of Operation Lifesaver, Inc. (OLI)—the Railway Progress Institute, Amtrak, and the Association of American Railroads—continue to serve on OLI's 11-member board of directors.

In 1987, the OLI board established a 33-member advisory council of volunteers drawn from a wide variety of partners nationwide. In 1989, OLI opened a national support center office in Alexandria, Virginia, serving the independent state programs and acting as a liaison to the federal government, other safety organizations, and the national media.

Funding for Operation Lifesaver was initially secured in 1987 from the Federal Railroad Administration (FRA), followed in 1988 by the Federal Highway Administration (FHWA). In 1992, Operation Lifesaver received a five-year authorization through the Intermodal Surface Transportation Efficiency Act of 1993, continued under the Transportation Equity Act for the 21st Century and the Safe, Accountable, Flexible, Efficient Transportation Equity Act.

A state Operation Lifesaver program usually begins with the establishment of an advisory and a coordinating committee. The advisory committee is made up of highly visible individuals from government agencies, civic organizations, and the railroad industry who support the program by their endorsements and by seeking the support of other influential persons. The support of the governor of the state is important and usually achieved. It is important that the advisory committee have representation from both the railroad industry and the state highway agencies to demonstrate the cooperative aspects of the program. The coordinating committee is responsible for the development and implementation of the Operation Lifesaver program.

Educational activities are varied. The goal is to reach as many people as possible through whatever medium is available and appropriate. There are 3,000 trained presenters throughout the states. Typically, they make presentations at schools, civic association meetings, and other gatherings. They distribute materials at fairs, in shopping centers, through the mail, and wherever people are gathered. They work with the media, television, radio, and newspapers to broadcast public service announcements, to appear on talk shows, and to print articles and editorials regarding crossings. They develop the materials, films, slide shows, and public service announcements that are distributed.

Many Operation Lifesaver programs work with drivers of special vehicles, such as school bus drivers and truck drivers, to educate them on their responsibilities and the potential danger at crossings. Operation Lifesaver developed updated training videos and DVDs for school bus drivers in 2005 and is currently updating its materials for truck and commercial bus driver training. In some states, associations representing these groups are actively involved in the program.

Many Operation Lifesaver programs work with driver training courses to ensure that safe driving practices at crossings are included in course material. Many state driving manuals have been revised to include or update the section on highway-rail grade crossings.

Although education may be considered the primary effort of Operation Lifesaver programs, many address enforcement, engineering, and evaluation as well. Enforcement of traffic laws is important to remind motorists of safe driving practices at crossings as well as to “punish” the reckless driver. Many state laws require motorists to stop at crossings at which flashing light signals are activated and not to proceed until it is safe to do so. Many drivers, however, do not stop. Other state laws prohibit drivers from moving around lowered gates; however, many drivers do so. Through the enforcement of these traffic laws and others, drivers will understand that these laws exist for their own safety.

In some states, local and/or state police have become active in Operation Lifesaver by making presentations and by writing citations when a motorist violates the law. This support is essential. It is also important to educate the police in the matter of traffic laws and safe driving practices at crossings. Many instances have occurred in which a police officer unknowingly violated the law or, when questioned, displayed lack of knowledge of crossing traffic laws.

Railroad police are also involved in Operation Lifesaver programs. They assist primarily in making presentations. Although they do not have the authority to stop and arrest motorists at crossings, they can arrest or warn trespassers. They also can assist by notifying the state or local police of unsafe driving practices occurring at specific crossings.

Railroads also assist by having locomotive crews report near misses. Train crews who observe drivers narrowly escaping a collision with a train can record the license plate number, or a commercial vehicle’s owning company or identifying number, and provide the Operation Lifesaver committee, the state or local police, or the railroad safety department with this information. Action can be taken to station police officers at crossings where near misses most often occur, to conduct an educational campaign in the community, or to visit the company owning the trucks whose drivers are observed to have unsafe driving practices.

Operation Lifesaver programs sometimes assist in the engineering aspects of crossing safety and operations. A combined effort conducting educational campaigns in a community while making engineering improvements at crossings has proven most effective in improving safety.

The Operation Lifesaver committee can assist by making the appropriate state and railroad engineers aware of crossings that may need engineering improvements.

Another area of concern for Operation Lifesaver programs is evaluation to ensure that the quality of the program is maintained and that it is reaching its stated goals.

Although Operation Lifesaver is designed to improve safety at highway-rail grade crossings, the program has many positive side effects. First, the cooperative effort among the state, local communities, and railroads often enhances relationships. Many communities have been aggravated by rail operations they may perceive to be too slow, too fast, too noisy, or unattractive. Through Operation Lifesaver, railroads and states work with their communities through established communication channels.

Another positive side effect is that, although the program's message is primarily directed toward motorists, it also pertains to pedestrians and trespassers. School children are a major safety concern around railroad tracks. Many children are inquisitive about the railroad and daring enough to play on the tracks. Educating children as well as adults about crossing safety assists them in obtaining a respect for railroad operations in general.

Although Operation Lifesaver programs are usually directed toward motorist behavior at public crossings, the same behavior is needed and desired at private crossings as well. People reached through Operation Lifesaver may be the same people who use private crossings.

Today, Operation Lifesaver programs are active nationwide in 49 states and the District of Columbia. More information about the program is available at its official Website.¹³⁸

B. Video Surveillance and Enforcement

In the 1990s, use of video surveillance became prevalent for a wide range of traffic monitoring and enforcement functions, including red-light running, speeding, and toll evasion. Use of video for traffic enforcement requires that the legal authority be granted by the state. California law requires "a clear photograph of a vehicle's license plate and the driver

of the vehicle," and numerous states have adopted provisions enabling its use.¹³⁹ Video surveillance in some instances is used for enforcement purposes; alternatively, a video record of events at a grade crossing, whether obtained by cameras mounted at the crossing or acquired from a cab-mounted recorder, can provide a recording of occurrences that may later be used either for safety improvement efforts or for providing evidence in conjunction with a court case.

In response to a March 15, 1999 collision at the McKnight Road grade crossing in Bourbonnais, Illinois, the National Transportation Safety Board (NTSB) went on record in support of the provision of grants to states to advance "innovative pilot programs" designed to increase enforcement of grade crossing traffic laws. In a follow-up recommendation, NTSB broadened support for video surveillance, noting that it believed such provisions could be effective not only at passive crossings but at active crossings as well. NTSB noted:

To increase the likelihood that grade crossing violations will not go undetected, some States, municipalities, and railroads have turned to the use of photo enforcement at grade crossings. In use throughout the world for more than 40 years, photo enforcement technology such as that used for identifying and citing those who run red lights has recently been adapted for use at grade crossings. In 1995, for example, the Los Angeles Metropolitan Transportation Authority (MTA) began a photo enforcement program that has been credited with reducing by almost 50 percent the number of grade crossing violations detected at 17 gated crossings along the Metro Blue Line route. Encouraged by the program's success, the MTA is planning to expand its use of photo enforcement by installing six more crossing video systems during the first half of 2002.¹⁴⁰

Note: Reductions of up to 90 percent resulted at some locations.¹⁴¹

A grade crossing photo enforcement pilot program has also recently been established in Illinois. The Illinois General Assembly

¹³⁹ *State of California 1998 Vehicle Code*. State of California Department of Motor Vehicles, 1998, Section 210.

¹⁴⁰ National Transportation Safety Board (NTSB). *Safety Recommendation*, February 15, 2002 (H-02-01).

¹⁴¹ "Photo Enforcement at Long Beach Blue Line Grade Crossings: Final Report." Los Angeles County Metropolitan Transportation Authority, December 31, 1997, pp. 1-11.

¹³⁸ Operation Lifesaver Website (www.oli.org).

in 1996 required the Illinois Commerce commission to conduct a study of the effectiveness of photo enforcement at grade crossings. According to the commission, it selected three grade crossings in DuPage County, Illinois, for the test... Fully functional in January 2000, photo enforcement at the grade crossing in the city of Wood Dale achieved a 47-percent decrease in the number of violations between January and September 2000. This crossing, which had formerly experienced three to four collisions per year, had only one collision in the pilot program's first 13 months of operation. Photo enforcement at the grade crossing in the city of Naperville was functional in July 2000, and the crossing has seen a 51-percent reduction in the number of violations.

In 2004, FRA partnered with the North Carolina Department of Transportation (NCDOT) and Norfolk Southern Railway in a \$482,000, federally-funded research project using locomotive-mounted digital video cameras to capture real-time data of actual highway-rail grade crossing collisions and trespass incidents. The project will collect video of thousands of miles of railroad operations and analyze both collisions and near misses. These types of data have never before been available for research purposes. The grant funding announced will be used for examination and analysis of the data collected.

NCDOT has installed video cameras on its Piedmont passenger train that operates daily between Raleigh and Charlotte, North Carolina. Norfolk Southern has video cameras on about 850 freight locomotives that operate in 22 states, the District of Columbia, and Ontario, Canada. The study will determine what human factors are involved in grade crossing collisions and trespass incidents. It also will evaluate the performance and effectiveness of current safety improvements made as part of North Carolina's Sealed Corridor Initiative, an aggressive effort to eliminate grade crossing hazards along a proposed future high-speed passenger rail route.¹⁴²

Norfolk Southern Railway on-board video uses a proprietary locomotive-mounted system that captures, at four frames per second, real-time digital video and audio of track conditions as well as unusual events,

142 "FRA Announces First Ever Use of Locomotive Mounted Cameras to Study Highway-Rail Grade Crossing Safety and Trespass Prevention." Federal Railway Administration (FRA), U.S. Department of Transportation (U.S DOT), Office of Public Affairs, October 19, 2004.

such as incidents and trespasser activity, through the use of a camera and microphone installed on the locomotive. This system also superimposes the speed of the train at any given point, train direction (forward or reverse), as well as horn and brake activations. As part of the research effort, Norfolk Southern will be recording video and sound for at least two years. NCDOT will utilize the data collected to monitor and evaluate the performance of the enhanced warning devices previously installed on the Sealed Corridor and will make design revisions as deemed necessary.

In addition, NCDOT Rail Division and Norfolk Southern are currently in the process of initiating a joint research project with FRA to develop and validate a predictive trespasser model utilizing the data collected on both the Sealed Corridor and Norfolk Southern's system as a whole. In addition to model calibration, the data will be used to determine the effectiveness of potential preventative measures designed to minimize pedestrian-train interactions.

C. Research and Development

The U.S. Department of Transportation (U.S. DOT) has been active in conducting crossing research. Specifically, FHWA and FRA are sponsors of crossing research and development efforts. Several studies can be found in the FHWA electronic reading room* and on the FRA Website.¹⁴³ The FRA Website has a list of highway-rail crossing publications from 1969 to 2005, included in this handbook as Appendix K.

Other sources of studies include the U.S. DOT online library, U.S. DOT Bureau of Transportation Statistics, National Technical Information Service, Transportation Research Information Service, Transit Cooperative Research Program, and Volpe National Transportation Systems Center.^{144, 145,146 ,147,148,149}

In addition to conducting research, FRA annually publishes a document that contains statistical information on crossings and crossing collisions. These data are generated from the U.S. DOT National Highway-Rail Crossing Inventory, of which FRA serves

* Federal Highway Administration (FHWA) Electronic Reading Room (www.fhwa.dot.gov/pubstats.html).

143 FRA Website (www.fra.dot.gov).

144 U.S. DOT Online Library (dotlibrary.dot.gov).

145 Bureau of Transportation Statistics Website (trisonline.bts.gov/search.cfm).

146 National Technical Information Service Website (www.ntis.gov).

147 Transportation Research Information Service Website (www4.trb.org/trb/tris.nsf).

148 Transit Cooperative Research Program Publications Website (www.trponline.org/publications_home.html).

149 Volpe National Transportation Systems Center Information Resources Website (www.volpe.dot.gov/infosrc/index.html).

as custodian, and from the Railroad Accident/Incident Reporting System.

The National Cooperative Highway Research Program is administered by the Transportation Research Board (TRB).

TRB also assists in disseminating research results through presentations made at its annual meeting each January. The TRB committee responsible for crossings, Committee A3A05, sponsors one or two sessions on crossings. The committee is also active in identifying areas of needed research and in encouraging an appropriate agency and/or organization to undertake the research. Two versions of a bibliography, *Highway-Rail Grade Crossings*, Bibliography 57 and 58, are available from TRB. Other TRB studies are available on its Website.¹⁵⁰

The Association of American Railroads (AAR) often conducts informal research and sometimes sponsors research by a contractor. For example, it participated in the funding of the compilation of state laws. AAR studies can be purchased from its Website.¹⁵¹

The American Railway Engineering and Maintenance-of-Way Association's Committee 9 on crossings is often active in informal research by its members' employers. This committee also identifies areas of needed research and encourages the most appropriate agency or organization to conduct the research.

NTSB conducts special studies on the safety aspects of a particular area pertaining to crossings. For example, it conducted a study on trucks carrying hazardous

materials at crossings. The report title is "Railroad/Highway Grade Crossing Accidents Involving Trucks Transporting Bulk Hazardous Materials." This and other NTSB studies can be found on its Website.¹⁵²

Individual railroads and crossing equipment suppliers often conduct special studies or research and development activities. For example, railroads often monitor the performance of a particular crossing surface or test the use of special lighting devices. Suppliers often conduct in-house research to identify improvements of existing products and develop new products.

D. References

Operation Lifesaver Program Guide. Chicago, Illinois: National Safety Council.

Rogers, William Charles. *The Effectiveness of Operation Lifesaver in Reducing Highway-Rail Grade Crossing Accidents*. College Station, Texas: Texas A&M University, December 1980.

¹⁵² NTSB Website (www.nts.gov).

¹⁵⁰ Transportation Research Board Publications Index Website (pubsindex.trb.org).

¹⁵¹ American Association of Railroads Publications Website (www.aar.org/pubstores).

Glossary

Abandonment. The relinquishment of interest (public or private) in right of way or activity thereon with no intention to reclaim or use again for highway or railroad purposes.

Accident rate. 1) The number of accidents, fatalities, or injuries divided by a measure of vehicle activity to provide a means of comparing accident trends through time. 2) The number of accidents per crossing per year.

Advance preemption. The notification of an approaching train that is forwarded to the highway traffic signal controller unit or assembly by the railroad equipment in advance of the activation of railroad warning devices.

Advance preemption time. The period of time that is the difference between the required maximum highway traffic signal preemption time and the activation of the railroad warning devices.

Allotment. An action by administrative authority making funds available for obligations and expenditures for specified purposes and for certain periods.

Anchors. Rail-fastening devices used to resist the longitudinal movement of rail under traffic and to maintain proper expansion allowance at joint gaps for temperature changes.

Apportionment. An administrative assignment of funds based on a prescribed formula by a governmental unit to another governmental unit for specific purposes and for certain periods.

Appropriation. An act of a legislative body that makes funds available for expenditures with specific limitations as to amount, purpose, and period.

At-grade intersection (crossing). An intersection

(crossing) where roadways (and railroads) join or cross at the same level.

Ballast. Material placed on a track roadbed to hold the track in alignment and elevation; it consists of hard principles that are stable, easily tamped, permeable, and resistant to plant growth.

Barrier gate. (Barrier gate arm, warning/barrier gate, vehicle arresting system.) An automatic gate used as adjunct to flashing light signals to provide positive protection by blocking approaching traffic at a highway-rail crossing and preventing vehicle penetration according to the requirements of National Cooperative Highway Research Program Report 350.

Benefit-cost ratio. The economic value of the reduction in fatalities, injuries, and property damage divided by the cost of the collision-reducing measure.

Branch line. A secondary line of railroad usually handling light volumes of traffic.

Cab. The space in a locomotive unit or “MU” car containing the operating controls and providing shelter and seats for the engine crew.

Cantilevered signal structure. A structure that is rigidly attached to a vertical pole and used to provide overhead support of signal units.

Catenary system. A system that consists of overhead supporting cables and a conductor (trolley wire) that supplies electricity to power rolling stock through contact with a pantograph or trolley current-collecting device (trolley pole).

Centralized Traffic Control (CTC). A traffic control system whereby train movements are directed through the remote operation of switches and signals from a central control point.

Clear storage distance. The distance available for vehicle storage measured between 1.8 meters (6 feet) from the rail nearest the intersection to the intersection stop line or the normal stopping point on the highway. At skewed highway-rail grade crossings and intersections, the 1.8-meter (6-foot) distance shall be measured perpendicular to the nearest rail either along the centerline or edge line of the highway, as appropriate, to obtain the shorter distance. Where exit gates are used, the distance available for vehicle storage is measured from the point where the rear of the vehicle would be clear of the exit gate arm. In cases where the exit gate arm is parallel to the track(s) and is not perpendicular to the highway, the distance is measured either along the centerline or edge line of the highway, as appropriate, to obtain the shorter distance.

Comparative negligence. A legal doctrine applicable in negligence suits, according to which the negligence of the plaintiff as well as that of the defendant is taken into account. Damages are based upon the outcome of a comparison of the two and are thus proportioned.

Consist. 1) The makeup or composition (number and specific identity) of a train of vehicles. 2) Contents.

Construction. The actual physical accomplishment of building, improving, or changing a highway-rail grade crossing or other finite facility.

Contract. The written agreement between the contracting agency and the contractor setting forth the obligations of the parties thereunder for the performance of the prescribed work. The contract includes the invitation for bids; proposal; contract form and contract bond; specifications; supplemental specifications; special provisions; general and detailed plans; and notice to proceed. The contract also includes any change orders and agreements required to complete the construction of the work in an acceptable manner, including authorized extensions thereof, all of which constitute one instrument.

Contractor. The individual, partnership, firm corporation, or any acceptable combination thereof, or joint venture, contracting with an agency for performance of prescribed work.

Corridor. A strip of land between two termini within which traffic, topography, environment, and other characteristics are evaluated for transportation purposes.

Cross section. A vertical section of the ground and facilities thereon at right angles to the centerline.

Crossing angle. The angle of 90 degrees or less at which a railroad and a highway intersect.

Crosstie. The wooden or concrete support upon which track rails rest, which holds them to gauge and transfers their load through the ballast to the subgrade.

Culvert. Any structure under the roadway with a clear opening of 20 feet or less measured along the center of the roadway.

Design vehicle. The longest vehicle permitted by statute of the road authority (state or other) on that roadway.

Diagnostic team. A group of knowledgeable representatives of the parties of interest in a highway-rail crossing or a group of crossings.

Do-nothing alternative. An alternative that refers to the existing state of the system.

Dynamic envelope. The clearance required for the train and its cargo overhang due to any combination of loading, lateral motion, or suspension failure.

Dynamic exit gate operating mode. A mode of operation where the exit gate operation is based on the presence of vehicles within the minimum track clearance distance.

Easement. A right to use or control the property of another for a designated purpose.

1. Drainage easement. An easement for directing the flow of water.
2. Planting easement. An easement for reshaping roadside areas and establishing, maintaining, and controlling plant growth thereon.
3. Sight line easement. An easement for maintaining or improving the sight distance.
4. Slope easement. An easement for cuts or fills.

Economic analysis. Determination of the cost-effectiveness of a project by comparing the benefits derived and the costs incurred in a project.

1. Cost-benefit analysis. A form of economic evaluation in which input is measured in terms of dollar costs and output is measured in terms of economic benefit of a project as compared to the incurred cost of the project.
2. Cost-effectiveness analysis. A comparison study between the cost of an improvement (initial plus maintenance) and the benefits

it provides. The latter may be derived from collisions reduced, travel time reduced, or increased volume of usage and translated into equivalent dollars saved.

Encroachment. Unauthorized use of highway or railroad right of way or easements as for signs, fences, buildings, etc.

Equipment rental rate. Equipment usage charges usually established on a time or mileage use basis, including direct costs, indirect costs, and depreciation.

Exit gate clearance time. For four-quadrant gate systems, the exit gate clearance time is the amount of time provided to delay the descent of the exit gate arm(s) after entrance gate arm(s) begin to descend.

Exit gate operating mode. For four-quadrant gate systems, the mode of control used to govern the operation of the exit gate arms.

Expenditures. A term applicable to accrual accounting, meaning total charges incurred, including expenses, provision for retirement of debt, and capital outlays. The making of a payment is a disbursement.

Flashing light signals. A warning device consisting of two red signal indications arranged horizontally that are activated to flash alternately when a train is approaching or present at a highway-rail grade crossing.

Force account work. Prescribed work paid for on the basis of actual costs and appropriate additives.

Functional classification. Division of a transportation network into classes or systems, according to the nature of the service they are to provide.

Grade. The rate of ascent or descent of a roadway, expressed as a percent; the change in roadway elevation per unit of horizontal length.

Grade separation. A crossing of two highways, or a highway and a railroad, at different levels.

Guardrails. Traffic barriers used to shield hazardous areas from errant vehicles.

Highway, street, or road. A general term denoting a public way for purposes of vehicular travel, including the entire area within the right of way.

Highway-rail grade crossing. The general area where a highway and a railroad cross at the same level,

within which are included the railroad, roadway, and roadside facilities for traffic traversing that area.

Pedestrian crossing. A highway-rail grade crossing used by pedestrians but not by vehicles.

Private crossing. A highway-rail grade crossing that is not a public highway-rail grade crossing, such as grade crossings that are on privately-owned roadways utilized only by the owner's licensees and invitees.

Public crossing. A highway-rail grade crossing that is on a roadway or a pathway under the jurisdiction of and maintained by a public authority and open to the traveling public.

Interconnection. The electrical connection between the railroad active warning system and the highway traffic signal controller assembly for the purpose of preemption.

Lading. Freight or cargo making up a shipment.

Lane. A strip of roadway used for a single line of vehicles.

1. Auxiliary lane. The portion of the roadway adjoining the through traveled way for parking, speed change, turning, storage for turning, weaving, truck climbing, or other purposes supplementary to through traffic movement.
2. Pullout lane. An auxiliary lane provided for removal from the through traffic lane those vehicles required to stop at all highway-rail grade crossings.
3. Speed-change lane. An auxiliary lane, including tapered areas, primarily for the acceleration or deceleration of vehicles entering or leaving the through traveled way.
4. Traffic lane. The portion of the traveled way for the movement of a single line of vehicles.

Line haul. The movement of freight over the tracks of a railroad from one town or city to another town or city.

Local freight train. A train with an assigned crew that works between predesignated points. These trains handle the switching outside the jurisdiction of a yard switcher.

Locomotive. A self-propelled unit of on-track equipment designed for moving other rail freight and passenger equipment on rail tracks.

Main line. The principal line or lines of a railway.

Main track. A track extending through yards and between stations, upon which trains are operated by timetable or train order or both, or the use of which is governed by block signals or by centralized traffic control.

Materials. Any substances specified for use in the construction of a project and its appurtenances.

Maximum highway traffic signal preemption time. The maximum amount of time needed following initiation of the preemption sequence for the highway traffic signals to complete the timing of the right-of-way transfer time, queue clearance time, and separation time.

Measure of effectiveness (MOE). A measurable unit or set of units assigned to each evaluation objective. The data collected in the units of the MOE will allow for a determination of the degree of achievement for that objective.

Minimum track clearance distance. For standard two-quadrant railroad warning devices, the minimum track clearance distance is the length along a highway at one or more railroad tracks, measured either from the highway stop line, warning device, or 3.7 meters (12 feet) perpendicular to the track centerline, to 1.8 meters (6 feet) beyond the track(s) measured perpendicular to the far rail, along the centerline or edge line of the highway, as appropriate, to obtain the longer distance.

For four-quadrant gate systems, the minimum track clearance distance is the length along a highway at one or more railroad tracks, measured either from the highway stop line or entrance warning device, to the point where the rear of the vehicle would be clear of the exit gate arm. In cases where the exit gate arm is parallel to the track(s) and is not perpendicular to the highway, the distance is measured either along the centerline or edge of the highway, as appropriate, to obtain the longer distance.

Minimum warning time—through train movements. The least amount of time active warning devices shall operate prior to the arrival of a train at a highway-rail grade crossing.

Pavement markings. Markings set into the surface of, applied upon, or attached to the pavement for the purpose of regulating, warning, or guiding traffic.

Pavement structure. The combination of subbase, base course, and surface course placed on a subgrade to support the traffic load and distribute it to the roadbed.

1. **Base course.** The layer or layers of specified or selected material of designed thickness placed on a subbase or subgrade to support a surface course.
2. **Surface course.** One or more layers of a pavement structure designed to accommodate the traffic load, the top layer of which resists skidding, traffic abrasion, and the disintegrating effects of climate. The top layer is sometimes called “wearing course.”
3. **Subbase.** The layer or layers of specified or selected material of designed thickness placed on a subgrade to support a base course.
4. **Subgrade.** The top surface of a roadbed upon which the pavement structure and shoulders, including curbs, are constructed.

Plaintiff. The person who begins an action at law; the complaining party in an action.

Plans. Contract drawings that show the location, character, and dimensions of the prescribed work, including layouts, profiles, cross sections, and other details.

Precedent. An adjudged case or judicial decision that furnishes a rule or model for deciding a subsequent case that presents the same or similar legal problems.

Preemption. The transfer of normal operation of highway traffic signals to a special control mode.

Preliminary engineering. The work necessary to produce construction plans, specifications, and estimates to the degree of completeness required for undertaking construction thereunder, including locating, surveying, designing, and related work.

Pre-signal. Supplemental highway traffic signal faces operated as part of highway intersection traffic signals, located in a position that controls traffic approaching the highway-rail grade crossing in advance of the intersection.

Queue clearance time. The time required for the design vehicle of maximum length stopped just inside the minimum track clearance distance to start up, move through, and clear the entire minimum track clearance distance. If pre-signals are present, this time shall be long enough to allow the vehicle to move through the intersection or to clear the tracks if there is sufficient clear storage distance. If a four-quadrant gate system is present, this time shall be long enough to permit the exit gate arm to lower after the design vehicle is clear of the minimum track clearance distance.

Rail joint. A fastening designed to unite abutting ends of rail.

Railroad line miles. The aggregate length of road of line-haul railroads. It excludes yard tracks, sidings, and parallel lines. Jointly used track is counted only once.

Railroad track miles. Total miles of railroad track including multiple main tracks, yard tracks, and sidings, owned by both line-haul and switching and terminal companies.

Right of way. A general term denoting land, property, or interest therein, usually in a strip, acquired for or devoted to transportation purposes.

Right-of-way transfer time. The maximum amount of time needed for the worst-case condition, prior to display of the track clearance green interval. This includes any railroad or highway traffic signal control equipment time to react to a preemption call and any traffic control signal green, pedestrian walk and clearance, yellow change, and red clearance intervals for conflicting traffic.

Roadway. The portion of a highway, including shoulders, for vehicular use. A divided highway has two or more roadways.

Salvage value. Estimated residual worth of program or project components at the end of their expected service lives.

Separation time. The component of maximum highway traffic signal preemption time during which the minimum track clearance distance is clear of vehicular traffic prior to the arrival of the train.

Service life. The period of time, in years, in which the components of a program or project can be expected to actively affect collision experience.

Shoulder. The portion of the roadway contiguous with the traveled way primarily for accommodation of stopped vehicles for emergency use and for lateral support of base and surface courses.

Sidewalk. That portion of the roadway primarily constructed for the use of pedestrians.

Simultaneous preemption. Notification of an approaching train is forwarded to the highway traffic signal controller unit or assembly and railroad active warning devices at the same time.

Sovereign immunity. The immunity of a government from being sued in its own courts except with its consent, or other exception.

Statute of limitations. A statute that imposes time limits upon the right to sue in certain cases.

Stopping sight distance. The length of highway required to safely stop a vehicle traveling at a given speed.

Superelevation rate. The rate of rise in cross section of the finished surface of a roadway on a curve, measured from the lowest or inside edge to the highest or outside edge.

Tie plate. A flanged plate between a rail and a crosstie that distributes the rail load over a larger area and helps hold track gauge.

Timed exit gate operating mode. A mode of operation where the exit gate descent is based on a predetermined time interval.

Timetable. 1) The authority for the movement of regular trains subject to the rules; it contains classified schedules with special instructions relating to the movement of trains and engines. 2) A listing of the times at which vehicles are due at specified time points (colloquial).

Tort. Any private or civil wrong by act or omission but not including breach of contract. Some torts may also be crimes.

Track. 1) An assembly of rails, ties, and fastenings over which cars, locomotives, and trains are moved. 2) The width of a wheeled vehicle from wheel to wheel and usually from the outside of the rims.

1. Double or multiple. Two or more main tracks over which trains may travel in both directions.
2. Single. 1) The main track on a roadbed having one main track upon which trains are operated in both directions. 2) In multiple-track territory, the process of running all trains, regardless of direction on one track while the other track(s) is (are) temporarily out of service.

Track gauge. The distance between the inside face of the heads of the two rails of a track, measured perpendicular to the center line. (Standard gauge in the United States is 4 to 8.5 inches.)

Traffic control device. A sign, signal, marking, or other device placed on or adjacent to a street or highway by authority of a public body or official having

jurisdiction to regulate, warn, or guide traffic.

1. **Active traffic control device.** Traffic control devices activated by the approach or presence of a train, such as flashing light signals, automatic gates, and similar devices, as well as manually-operated devices and crossing watchmen, all of which display to motorists positive warning of the approach or presence of a train.
2. **Passive traffic control device.** Types of traffic control devices, including signs, markings, and other devices, located at or in advance of grade crossings to indicate the presence of a crossing but that do not change aspect upon the approach or presence of a train.
3. **Traffic control signal.** Any device, whether manually, electrically, or mechanically operated, by which traffic is alternately directed to stop or permitted to proceed.
4. **Traffic markings.** All lines, patterns, words, colors, or other devices, except signs, set into the surface of, applied upon, or attached to the pavement or curbing or to the objects within or adjacent to the roadway, officially placed for the purpose of regulating, warning, or guiding traffic.

Track miles. The total centerline length of mainline trackage in a corridor; for example, a two-track mainline typically has twice the track miles as route miles.

Traffic operation plan. A program of action designed to improve the utilization of a highway, a street, or highway and street network, through the application of the principles of traffic engineering.

Traffic sign. A device mounted on a fixed or portable support whereby a specific message is conveyed by means of words or symbols, officially erected for the purpose of regulating, warning, or guiding traffic.

Traffic signal. A power-operated traffic control device by which traffic is regulated, warned, or alternately directed to take specific actions.

1. **Cycle time.** The time required for one complete sequence of signal indications.
2. **Detectors.** Mechanical or electronic devices that sense and signal the presence or passage of vehicular or railroad traffic at one or more points in the roadway or track.
3. **Phase.** Those right-of-way and clearance intervals in a cycle assigned to any independent movement(s) of vehicular traffic.

Train. 1) One or more locomotive units with or without connected cars. 2) Two or more vehicles physically connected and operated as a unit.

1. **Through.** A freight train operating between major classification yards and serving non-local traffic.
2. **Unit.** A freight train moving great tonnage of single bulk products between two points coupled with a system of efficient, rapid loading and unloading facilities.

Train orders. Authorization to move a train as given by a train dispatcher either in writing or verbally.

Traveled way. The portion of the roadway for the movement of vehicles, exclusive of shoulders.

Vehicle. A means of carrying or transporting something.

1. **Bicycle.** A vehicle having two tandem wheels, propelled solely by human power, upon which any person or persons may ride.
2. **Bus.** A self-propelled rubber-tired vehicle designed to accommodate 15 or more passengers and to operate on streets and roads. Federal Motor Carrier Safety Administration regulations define a “bus” for the purposes of highway-rail grade crossing safety as “any motor vehicle designed, constructed, and or used for the transportation of passengers, including taxicabs.” (49 CFR 390.5)
3. **Design vehicle.** A selected motor vehicle, the weight, dimensions, and operating characteristics of which are used in highway design.
4. **Motorcycle.** A two-wheeled motorized vehicle having one or two saddles and, sometimes, a sidecar with a third supporting wheel.
5. **Passenger car.** A motor vehicle, except motorcycles, designed for carrying 10 passengers or less and used for the transportation of persons.
6. **Semitrailer.** Any motor vehicle, other than a pole trailer, designed to be drawn by another motor vehicle and constructed so that some part of its weight rests upon the self-propelled towing motor vehicle. (49 CFR 390.5)
7. **Special vehicle.** A vehicle whose driver is required by law to stop in advance of all highway-rail grade crossings. Typically, special vehicles include commercial vehicles transporting passengers, trucks carrying hazardous materials, and school buses.

-
8. Truck tractor. A self-propelled commercial motor vehicle designed and/or used primarily for drawing other vehicles. (49 CFR 390.5)

Vehicle intrusion detection devices. A detector or detectors used as a part of a system incorporating processing logic to detect the presence of vehicles within the minimum track clearance distance and to control the operation of the exit gates.

Volume. The number of vehicles passing a given point during a specified period of time.

1. Average daily traffic (ADT). The average 24-hour volume, being the total volume during a stated period divided by the number of days in that period. Unless otherwise stated, the period is a year.
2. Design volume. A volume determined for use in design, representing traffic expected to use the highway. Unless otherwise stated, it is an hourly volume.

Warrants. The minimum conditions that would justify the establishment of a particular traffic control regulation or device, usually including items such as traffic volumes, geometries, traffic characteristics, collision experience, etc.

Wayside equipment. The signals, switches, and/or control devices for railroad operations housed within one or more enclosures located along the railroad right of way and/or on railroad property.

Yard. A system of tracks within defined limits provided for making up trains, storing cars, and other purposes.

Index

APPENDIX

B

A

Abandonment 76, 83

Accident Prediction Formulae 54

 collision costs 155

 collisions 2, 3, 4, 5, 11, 12, 13, 14, 15, 18, 20, 21, 25, 27, 28, 30, 31, 32, 33, 35, 36, 39, 43, 45, 47, 51, 54, 55, 56, 62, 70, 71, 76, 77, 78, 80, 82, 98, 104, 108, 125, 141, 155, 156, 157, 161, 162, 163, 187, 188, 191, 192, 194, 195, 197, 205, 206, 207, 212, 215, 218, 219, 223

Active traffic control devices 97, 98

Advance warning signs 88

Agreements 170

American Association of State Highway and Transportation Officials (AASHTO) 28, 63, 65, 78, 81, 89, 90, 108, 139, 140, 141

American Railway Engineering and Maintenance-of-Way Association (AREMA) 19, 22, 104, 115, 119, 123, 129, 130, 139, 141

American Short Line and Regional Railroad Association (ASLRRA) 193

Annual average daily traffic 149, 247

Annual average daily traffic 149, 247

Association of American Railroads (AAR) 17, 22, 50, 219

Automatic gates 162, 192, 249

B

Ballast 44, 222

Barricades 179

Benefit-cost analysis 145

Bicycles 205, 206

Buses 28, 29, 30, 206

C

Cantilevered flashing lights 100

Channelizing devices 177, 179

Closure 73, 78, 79, 80, 81, 150, 183, 308, 315, vi

Cost-effectiveness analysis 223

Crossbucks 26, 192, 250

D

“Do Not Stop on Tracks” signs 17, 93

Delineators 179

Drainage 138, 142, 186, 223

E

Economic analysis 154, 188, 223

Elimination 7, 8, 76, 78

Engineering studies 62

Evaluation 63, 64, 65, 82, 159, 160, 187, 189, 208, 212, 213, 249, 253, 302, 304, 307, 309, 311, 314

Exposure index 57, 58

F

Federal Highway Administration (FHWA) 2, 7, 9, 12, 13, 14, 15, 17, 19, 21, 22, 25, 32, 33, 34, 41, 45, 46, 47, 50, 51, 62, 70, 71, 73, 74, 75, 76, 77, 78, 79, 82, 87, 92, 110, 112, 113, 114, 115, 116, 122, 124, 129,

- 136, 143, 144, 145, 151, 155, 165, 168, 169, 170, 171, 172, 173, 180, 184, 185, 186, 187, 189, 209, 212, 216, 218, 302, 305, 306, 307, 308, 310, 311, 312, 313, 314, 315, 316
- Federal Railroad Administration (FRA) 3, 7, 13, 14, 17, 21, 22, 32, 33, 36, 37, 38, 39, 41, 42, 43, 44, 45, 46, 50, 51, 55, 58, 71, 74, 75, 78, 81, 83, 86, 104, 105, 106, 110, 112, 143, 144, 145, 150, 153, 162, 163, 165, 193, 209, 210, 212, 213, 216, 218, 219, 301, 302, 303, 304, 305, 306, 307, 308, 309, 310, 311, 312, 313, 314, 315, 316
- Flagging 174, 180
- Funding 9, 11, 72, 167, 169, 170, 216, 9, 11, 72, 167, 169, 170, 216
- G**
- Gate 58, 83, 110, 200, 201, 303
- H**
- Horizontal alignment 137, 247
- I**
- Institute of Transportation Engineers (ITE) 114, 116
- Interstate Commerce Commission (ICC) 6
- L**
- Liability 7, 19, 20, 21, 212, 304
- Locomotives 35, 36, 45, 304
- M**
- Maintenance 17, 19, 22, 39, 47, 73, 104, 107, 129, 143, 144, 155, 157, 170, 185, 186, 207, 219, 315
- Materials Transportation Bureau 54, 241
- Motorcycles 28, 205, 206
- N**
- National Highway Traffic Safety Administration (NHTSA) 13, 155
- National Safety Council (NSC) 155
- National Transportation Safety Board (NTSB) 13, 30, 54, 217, 233
- Net annual benefit 158
- O**
- Operation Lifesaver 17, 194, 206, 207, 215, 216, 217, 219, 272, 305
- P**
- Passive traffic control devices 83
- Pavement markings 66, 95, 178, 185, 225
- Pedestrians 31, 200, 201, 204, 205, 207
- Private crossings 2, 205
- Public crossings 2
- R**
- Railroad line miles 225
- Railroad relocation 77, 78
- Railroad track miles 225
- Railway Progress Institute 144, 215
- Research 14, 15, 17, 23, 54, 70, 71, 72, 74, 77, 79, 88, 97, 98, 110, 115, 116, 118, 128, 134, 143, 144, 155, 187, 189, 194, 195, 196, 197, 198, 199, 200, 201, 202, 204, 208, 218, 219, 222, 249, 301, 302, 304, 308, 309, 310, 311, 312, 314
- S**
- School buses 85
- Short-line railroads 193, 194
- Sight distance 10, 32, 66, 100, 203, 205, 247, 270
- Solar energy 114
- Special vehicles 30, 76
- STOP signs 17, 26, 34, 88, 92, 93, 128, 155, 156, 168, 192, 193, 203
- Surfaces 17, 141, 143, 144
- T**
- Traffic control devices 25, 63, 70, 136, 185, 194, 226
- Train detection circuits 73
- Transportation Research Board (TRB) 194, 219
- Trucks 28, 29, 30, 46, 74, 205, 206, 214, 219
- Turn prohibition signs 95

U

U.S. Department of Transportation (U.S. DOT) 7, 8, 11,
13, 15, 17, 22, 23, 25, 31, 32, 33, 36, 47, 48, 50, 55,
56, 57, 14, 58, 59, 60, 61, 62, 70, 71, 75, 80, 83, 98,
99, 104, 116, 129, 137, 139, 142, 143, 145, 146, 149,
151, 152, 161, 162, 163, 168, 191, 218, 219, 315,
316

U.S. DOT National Rail-Highway Crossing Inventory
143

Uniform Vehicle Code 26, 46, 76, 144, 196

V

Vehicle miles 2, 28

Vertical alignment 138, 247

W

Warning time 128

Wigwags 99, 250

Work zones 229

APPENDIX

C

Example Crash Reporting Form, State of Oklahoma

Incident Report

Investigation Completed

Revised

Investigation Made at Scene

Fatality

Photographs

Hit and Run

OFFICIAL OKLAHOMA TRAFFIC COLLISION REPORT

(1) Reporting Agency Case Number (Agency Use) Motor Vehicles Involved Number Injured Number Killed

(2) Date of Collision (mm/dd/yyyy) Time County Number and Name Nearest City or Town Number and Name

(3) Distance from Nearest City or Town Limits Control # Int ID Location East Grid North Grid Administrative

(4) Street, Road or Highway Distance from (Nearest) Intersecting Street, Road or Highway

(5) Unit Occupants Type Hit & Run CMV Last Name First Middle Date of Birth (mm/dd/yyyy) Sex

(6) Address City State Zip Telephone (Use Area Code)

(7) Driver License Number State Class Endorsement(s) Restriction(s) Inj. Sev. Type of Injury Drv./Ped. Cond. OP Use

(8) Ejected Extricated Test (% BAC) Transported by To Medical Facility License Plate Number State Month Year

(9) VIN Vehicle Year Color 2nd Color Make Model Veh. Conf. Extent of Damage

(10) Insurance Company Name Policy Number Insurance Telephone (Use Area Code)

(11) Vehicle Removed by Driver Owner's Last Name First Middle Initial

(12) Owner's Address City State Zip Towed Veh. Type Oversized Load Rolled Burned Phone present Phone in use

(13) Citation Number Statute/Ordinance Number Citation Number Statute/Ordinance Number

(14) Unit Occupants Type Hit & Run CMV Last Name First Middle Date of Birth (mm/dd/yyyy) Sex

(15) Address City State Zip Telephone (Use Area Code)

(16) Driver License Number State Class Endorsement(s) Restriction(s) Inj. Sev. Type of Injury Drv./Ped. Cond. OP Use

(17) Ejected Extricated Test (% BAC) Transported by To Medical Facility License Plate Number State Month Year

(18) VIN Vehicle Year Color 2nd Color Make Model Veh. Conf. Extent of Damage

(19) Insurance Company Name Policy Number Insurance Telephone (Use Area Code)

(20) Vehicle Removed by Driver Owner's Last Name First Middle Initial

(21) Owner's Address City State Zip Towed Veh. Type Oversized Load Rolled Burned Phone present Phone in use

(22) Citation Number Statute/Ordinance Number Citation Number Statute/Ordinance Number

(23) Investigating Officer Badge Number Troop/Div. Reviewed by (Init.) Reviewer Badge Number Date of Report (mm/dd/yyyy)

Legend table with columns: Unit Type, Injury Severity, Type of Injury, Driver/Pedestrian Condition, Occupant Protection (OP) In Use, Air Bag Deployed, Ejected, Extricated, Chemical Test, Extent of Damage, Insurance Verification, Oversized Load, Towed Vehicle Type.

WARNING - STATE LAW Use of contents for commercial solicitation is unlawful

(24) Unit	<input type="checkbox"/> Injured <input type="checkbox"/> Witness	<input type="checkbox"/> Passenger <input type="checkbox"/> Prop. Owner	Pos in Veh.	Last Name	First	Middle Initial	Date of Birth (mm/dd/yyyy)	Sex
(25) Address _____ City _____ State _____ Zip _____ Telephone (Use Area Code) _____								
(26) Injury Severity / Type _____ OP Use _____ Air Bag Ejected _____ Extricated _____ Transported by _____ To Medical Facility _____ Property Type _____								
(27) Unit	<input type="checkbox"/> Injured <input type="checkbox"/> Witness	<input type="checkbox"/> Passenger <input type="checkbox"/> Prop. Owner	Pos in Veh.	Last Name	First	Middle Initial	Date of Birth (mm/dd/yyyy)	Sex
(28) Address _____ City _____ State _____ Zip _____ Telephone (Use Area Code) _____								
(29) Injury Severity / Type _____ OP Use _____ Air Bag Ejected _____ Extricated _____ Transported by _____ To Medical Facility _____ Property Type _____								
(30) Unit	<input type="checkbox"/> Injured <input type="checkbox"/> Witness	<input type="checkbox"/> Passenger <input type="checkbox"/> Prop. Owner	Pos in Veh.	Last Name	First	Middle Initial	Date of Birth (mm/dd/yyyy)	Sex
(31) Address _____ City _____ State _____ Zip _____ Telephone (Use Area Code) _____								
(32) Injury Severity / Type _____ OP Use _____ Air Bag Ejected _____ Extricated _____ Transported by _____ To Medical Facility _____ Property Type _____								
(33) Unit	<input type="checkbox"/> Injured <input type="checkbox"/> Witness	<input type="checkbox"/> Passenger <input type="checkbox"/> Prop. Owner	Pos in Veh.	Last Name	First	Middle Initial	Date of Birth (mm/dd/yyyy)	Sex
(34) Address _____ City _____ State _____ Zip _____ Telephone (Use Area Code) _____								
(35) Injury Severity / Type _____ OP Use _____ Air Bag Ejected _____ Extricated _____ Transported by _____ To Medical Facility _____ Property Type _____								

Complete information below if this vehicle is being used for COMMERCE/BUSINESS and has a GVWR/GCWR IN EXCESS OF 10,000 LBS., or has a HAZMAT PLACARD, or is a BUS WITH SEATING FOR NINE OR MORE INCLUDING THE DRIVER

(36) Unit	Carrier Name _____	Address _____
(37) City	State	Zip
(38) U.S. DOT Number _____ Vehicle Inspection Number OK _____ Placard Number _____ Haz. Mat. Class _____ Haz. Mat. Involved _____ Haz. Mat. Release _____		
(39) Unit	Carrier Name _____	Address _____
(40) City	State	Zip
(41) U.S. DOT Number _____ Vehicle Inspection Number OK _____ Placard Number _____ Haz. Mat. Class _____ Haz. Mat. Involved _____ Haz. Mat. Release _____		

<h3 style="text-align:center;">Position in Vehicle</h3>	<h3 style="text-align:center;">Vehicle Configuration</h3> <table style="width:100%;"> <tr> <td>00. N/A</td> <td>07. School Bus</td> <td>13. Bus/Large Van 9-15 occupants including driver</td> <td>18. Farm Machinery</td> </tr> <tr> <td>01. Passenger Veh.-2 Dr</td> <td>08. Truck/Trailer</td> <td>14. Bus 16+ occupants including driver</td> <td>19. ATV</td> </tr> <tr> <td>02. Passenger Veh.-4 Dr</td> <td>09. Truck-Tractor (Bobtail)</td> <td>15. Motorcycle</td> <td>20. SUV</td> </tr> <tr> <td>03. Passenger Veh. Conv.</td> <td>10. Truck-Tractor/ Semi-Trailer</td> <td>16. Motor Scooter/ Moped</td> <td>21. Passenger Van</td> </tr> <tr> <td>04. Pickup</td> <td>11. Truck-Tractor/ Double</td> <td>17. Motor Home</td> <td>22. Truck more than 10,000 lbs., Cannot Classify</td> </tr> <tr> <td>05. Single Unit Truck, 2 axles</td> <td>12. Truck-Tractor/ Triple</td> <td></td> <td>23. Van 10,000 lbs. or Less</td> </tr> <tr> <td>06. Single Unit Truck, 3+ axles</td> <td></td> <td></td> <td>24. Other</td> </tr> <tr> <td></td> <td></td> <td></td> <td>99. Unknown</td> </tr> </table>	00. N/A	07. School Bus	13. Bus/Large Van 9-15 occupants including driver	18. Farm Machinery	01. Passenger Veh.-2 Dr	08. Truck/Trailer	14. Bus 16+ occupants including driver	19. ATV	02. Passenger Veh.-4 Dr	09. Truck-Tractor (Bobtail)	15. Motorcycle	20. SUV	03. Passenger Veh. Conv.	10. Truck-Tractor/ Semi-Trailer	16. Motor Scooter/ Moped	21. Passenger Van	04. Pickup	11. Truck-Tractor/ Double	17. Motor Home	22. Truck more than 10,000 lbs., Cannot Classify	05. Single Unit Truck, 2 axles	12. Truck-Tractor/ Triple		23. Van 10,000 lbs. or Less	06. Single Unit Truck, 3+ axles			24. Other				99. Unknown	<h3 style="text-align:center;">Cargo Body Type</h3> <table style="width:100%;"> <tr> <td>00. N/A</td> <td>06. Intermodal</td> <td>11. Hopper (grain/ chips/gravel)</td> </tr> <tr> <td>01. Bus 9-15 seats</td> <td>07. Dump Truck/ Trailer</td> <td>12. Pole Trailer</td> </tr> <tr> <td>02. Bus 16+ seats</td> <td>08. Concrete Mixer</td> <td>13. Log Trailer</td> </tr> <tr> <td>03. Van/Enclosed Box</td> <td>09. Auto Transporter</td> <td>14. Vehicle Towing Vehicle</td> </tr> <tr> <td>04. Cargo Tank</td> <td>10. Garbage/Refuse</td> <td>15. Other</td> </tr> <tr> <td>05. Flatbed</td> <td></td> <td>99. Unknown</td> </tr> </table>	00. N/A	06. Intermodal	11. Hopper (grain/ chips/gravel)	01. Bus 9-15 seats	07. Dump Truck/ Trailer	12. Pole Trailer	02. Bus 16+ seats	08. Concrete Mixer	13. Log Trailer	03. Van/Enclosed Box	09. Auto Transporter	14. Vehicle Towing Vehicle	04. Cargo Tank	10. Garbage/Refuse	15. Other	05. Flatbed		99. Unknown
00. N/A	07. School Bus	13. Bus/Large Van 9-15 occupants including driver	18. Farm Machinery																																																	
01. Passenger Veh.-2 Dr	08. Truck/Trailer	14. Bus 16+ occupants including driver	19. ATV																																																	
02. Passenger Veh.-4 Dr	09. Truck-Tractor (Bobtail)	15. Motorcycle	20. SUV																																																	
03. Passenger Veh. Conv.	10. Truck-Tractor/ Semi-Trailer	16. Motor Scooter/ Moped	21. Passenger Van																																																	
04. Pickup	11. Truck-Tractor/ Double	17. Motor Home	22. Truck more than 10,000 lbs., Cannot Classify																																																	
05. Single Unit Truck, 2 axles	12. Truck-Tractor/ Triple		23. Van 10,000 lbs. or Less																																																	
06. Single Unit Truck, 3+ axles			24. Other																																																	
			99. Unknown																																																	
00. N/A	06. Intermodal	11. Hopper (grain/ chips/gravel)																																																		
01. Bus 9-15 seats	07. Dump Truck/ Trailer	12. Pole Trailer																																																		
02. Bus 16+ seats	08. Concrete Mixer	13. Log Trailer																																																		
03. Van/Enclosed Box	09. Auto Transporter	14. Vehicle Towing Vehicle																																																		
04. Cargo Tank	10. Garbage/Refuse	15. Other																																																		
05. Flatbed		99. Unknown																																																		

		Pedestrian / Pedalcyclist Only																					
		Unit		Total Lanes in Roadway		Legal Speed		Actions Prior to Collision		Location at Time of Collision		Safety Equip.		Unit Number of Vehicle Striking									
This unit will correspond to 'Unit 1'		[] []		[] []		[] []		[] []		[] []		[] []		[] []									
This unit will correspond to 'Unit 2'		[] []		[] []		[] []		[] []		[] []		[] []		[] []									
Light 1 Daylight 2 Dark-Not Lighted 3 Dark-Lighted 4 Dawn 5 Dusk 6 Dark-Unknown Lighting 7 Other 9 Unknown		What Vehicle Was Going to Do Unit 1 [] [] Unit 2 [] [] 00 Not Applicable 01 Go Ahead 02 Turn Left 03 Turn Right 04 Make "U" Turn 05 Stop 06 Slow for Cause 07 Start from Park/Stop 08 Change Lanes 09 Overtake 10 Pass 11 Back 12 Remain Stopped 13 Remain Parked 14 Enter/Merge in Traffic 15 Negotiate a Curve 16 Park 17 Other 99 Unknown		Underride/Override Unit 1 [] [] Unit 2 [] [] 0 Not Applicable 1 No Underride or Override 2 Underride, Compartment Intrusion 3 Underride, No Compartment Intrusion 4 Underride, Compartment Intrusion Unknown 5 Override, Motor Vehicle in Transport 6 Override, Other Motor Vehicle 9 Unknown		Traffic Control Unit 1 [] [] Unit 2 [] [] 00 No Control 01 Stop Sign 02 Traffic Signal 03 Flashing Traffic Signal 04 School Zone Signs 05 Yield Sign 06 Warning Sign 07 Railroad Advance Warning Sign 08 Railroad Cross Bucks 09 Railroad Gates 10 Railroad Signal 11 No Passing Zone 12 Person (including flagger, law enforcement, crossing guard, etc.) 13 Abnormal Control 14 Posted Speed 15 Other 99 Unknown		Road Surface Conditions Unit 1 [] [] Unit 2 [] [] 01 Dry 02 Wet 03 Ice/Frost 04 Snow 05 Mud, Dirt, Gravel 06 Slush 07 Water (standing, moving) 08 Sand 09 Oil 10 Other 99 Unknown		Road Character Unit 1 [] [] Unit 2 [] [] Grade 1 Level 2 Hillcrest 3 Uphill 4 Downhill 5 Sag (bottom) <hr/> Horizontal Alignment Unit 1 [] [] Unit 2 [] [] 1 Straight 2 Curve - Left 3 Curve - Right		Road Surface Type Unit 1 [] [] Unit 2 [] [] 1 Concrete 2 Asphalt 3 Gravel 4 Dirt 5 Brick 6 Other 9 Unknown		Driver Distracted by Unit 1 [] [] Unit 2 [] [] 0 Not Applicable/None 1 Electronic Communication Devices 2 Other Electronic Device 3 Other Inside Vehicle 4 Other Outside Vehicle 9 Unknown		Emergency Vehicle Responding to an Emergency Unit 1 [] [] Unit 2 [] [] 0 N/A 1 Yes 2 No 9 Unknown		Was the collision in or near a construction, maintenance or utility work zone? (If yes, complete this section) Yes <input type="checkbox"/> No <input type="checkbox"/> Type of Work Zone 1 Lane Closure 2 Lane Shift/Crossover 3 Work on Shoulder or Median 4 Intermittent or Moving Work 9 Unknown [] []		Location of the Work Zone Collision 1 Before the First Work Zone Warning Sign 2 Advance Warning Area 3 Transition Area 4 Activity Area 5 Termination Area 9 Unknown [] []		Workers Present Yes <input type="checkbox"/> No <input type="checkbox"/> Unknown <input type="checkbox"/>	
Weather 01 Clear 02 Fog/Smog/Smoke 03 Cloudy 04 Rain 05 Snow 06 Sleet/Hail (Freezing Rain/Drizzle) 07 Severe Crosswind 08 Blowing Snow 09 Blowing Sand, Soil, Dirt 10 Other 99 Unknown		What Vehicle Did Unit 1 [] [] Unit 2 [] [] 00 Not Applicable 01 Went Ahead 02 Turned Left 03 Turned Right 04 Entered "U" Turn 05 Stopped 06 Slowed 07 Started From Park/Stop 08 Entered Other Lane 09 Overtaking 10 Passing 11 Backed 12 Remained Stopped 13 Remained Parked 14 Entered/Merged 15 Departed Rdwy-Right 16 Departed Rdwy-Left 17 Swerved Right 18 Swerved Left 19 Parked 20 Other 99 Unknown		Trafficway Unit 1 [] [] Unit 2 [] [] 0 Not Applicable 1 Two-Way, Not Divided 2 Two-Way, Not Divided with a Continuous Left Turn Lane 3 Two-Way, Divided, Unprotected (painted > 4 feet) Median 4 Two-Way, Divided, Positive Median Barrier 5 Two-Way, Divided, Cable Barrier 6 One-Way 9 Unknown		Vehicle Removal Unit 1 [] [] Unit 2 [] [] 0 Not Applicable 1 Towed Due to Vehicle Damage 2 Towed For Reasons Other Than Damage 3 Remained at Scene 4 Driven from Scene 9 Unknown		Vehicle Condition Unit 1 [] [] Unit 2 [] [] 00 Not Applicable 01 Apparently Normal 02 Brakes 03 Headlights 04 Steering 05 Tail Lights 06 Brake Lights 07 Tires/Wheels 08 Suspension 09 Signal lights 10 Windows 11 Truck Coupling/Trailer Hitch/Safety Chains 12 Mirrors 13 Wipers 14 Power Train 15 Other 99 Unknown		Special Function of Vehicle Unit 1 [] [] Unit 2 [] [] 00 Not Applicable 01 School Bus 02 Transit Bus 03 Intercity Bus 04 Charter Bus 05 Other Bus 06 Military 07 OHP 08 Other Police 09 Other Law Enforcement 10 Ambulance 11 Fire Truck 12 Public Owned Vehicle 13 Highway Equipment 14 Special Mobilized Machine 15 Other 99 Unknown		Unsafe / Unlawful Contributing Factors Unit 1 [] [] Unit 2 [] [] FAILED TO YIELD 01 From Stop Sign 02 From Yield Sign 03 Private Drive 04 County Road at Through Highway 05 From Signal Light 06 From Alley 07 To Pedestrian 08 To Vehicle on Right 09 To Vehicle in Intersection 10 To Emergency Vehicles 12 Other FOLLOWED TOO CLOSELY 13 Human Element 14 Traffic Condition 15 Weather Condition UNSAFE SPEED 16 Driver's Ability (Age) 17 Inexperienced Driver - Young 18 Exceeding Legal Limit 19 For Traffic Conditions 20 For Type of Roadway (Gravel, Dirt, etc.) 21 For Ice or Snow on Roadway 22 Rain or Wet Roadway 23 Wind 24 Other Weather Conditions 25 Vehicle Condition 26 View Obstruction 27 On Curve/Turn 28 Impeding Traffic 29 Other IMPROPER TURN 30 From Wrong Lane 31 From Direct Course 32 Right 33 Left 34 Turn About/U-Turn 35 To Enter Private Drive 36 In Front of Oncoming Traffic 37 Other CHANGED LANES UNSAFELY 38 STOPPED IN TRAFFIC LANE FAILED TO STOP 40 For Stop Sign 41 For Traffic Signal 42 For School Bus 43 For Railroad Gates/Signal 44 For Officer/Flagman 45 At Sidewalk/Stopline 46 Other UNSAFE VEHICLE 47 Brakes 48 Steering		Point of First Contact on Vehicle Unit 1 [] [] Unit 2 [] [] Most Damaged Area Unit 1 [] [] Unit 2 [] [] 13 Top 14 Undercarriage 15 Non-Collision 99 Unknown									
Locality 1 Residential 2 Business 3 Industrial 4 School 5 Not Built-up 6 Mixed Use 7 Other 9 Unknown		Visibility Obscured by Unit 1 [] [] Unit 2 [] [] 00 Not Applicable 01 Trees 02 Embankment 03 Building 04 Signs 05 Parked Vehicles 06 High Weeds 07 Fences 08 Shrubbery 09 Ice, Snow or Frost on Windows 10 Smoke 11 Fog 12 Dust 13 Rain 14 Sun 15 Other 99 Unknown		Incident Type [] [] 00 Not an Incident 51 Private Property 52 Deliberate Intent 53 Medical Condition 54 Legal Intervention 55 Suicide 57 Drowning 58 Other		Location of First Harmful Event [] [] 01 On Roadway 02 Shoulder 03 Median 04 Roadside 05 Gore 06 Separator 07 Parking Lane/Zone 08 Off Roadway, Location Unknown 09 Outside Right-of-Way 10 Other 99 Unknown		Point of First Contact on Vehicle Unit 1 [] [] Unit 2 [] [] Most Damaged Area Unit 1 [] [] Unit 2 [] [] 13 Top 14 Undercarriage 15 Non-Collision 99 Unknown															

OFFICIAL OKLAHOMA TRAFFIC COLLISION REPORT PERSONS SUPPLEMENTAL

Case Number _____

(42) Unit		Pos in Veh.		Last Name			First			Middle Initial			Date of Birth (mm/dd/yyyy)				Sex					
<input type="checkbox"/>	<input type="checkbox"/>	<input type="checkbox"/>	<input type="checkbox"/>														<input type="checkbox"/>					
<input type="checkbox"/>	<input type="checkbox"/>	<input type="checkbox"/>	<input type="checkbox"/>														<input type="checkbox"/>					
(43) Address													City		State		Zip		Telephone (Use Area Code)			
Same as Driver													<input type="checkbox"/>		<input type="checkbox"/>		<input type="checkbox"/>		<input type="checkbox"/>			
(44) Injury Severity / Type		OP Use		Air Bag Ejected		Extricated		Transported by		To Medical Facility				Property Type								
(45) Unit		Pos in Veh.		Last Name			First			Middle Initial			Date of Birth (mm/dd/yyyy)				Sex					
<input type="checkbox"/>	<input type="checkbox"/>	<input type="checkbox"/>	<input type="checkbox"/>														<input type="checkbox"/>					
<input type="checkbox"/>	<input type="checkbox"/>	<input type="checkbox"/>	<input type="checkbox"/>														<input type="checkbox"/>					
(46) Address													City		State		Zip		Telephone (Use Area Code)			
Same as Driver													<input type="checkbox"/>		<input type="checkbox"/>		<input type="checkbox"/>		<input type="checkbox"/>			
(47) Injury Severity / Type		OP Use		Air Bag Ejected		Extricated		Transported by		To Medical Facility				Property Type								
(48) Unit		Pos in Veh.		Last Name			First			Middle Initial			Date of Birth (mm/dd/yyyy)				Sex					
<input type="checkbox"/>	<input type="checkbox"/>	<input type="checkbox"/>	<input type="checkbox"/>														<input type="checkbox"/>					
<input type="checkbox"/>	<input type="checkbox"/>	<input type="checkbox"/>	<input type="checkbox"/>														<input type="checkbox"/>					
(49) Address													City		State		Zip		Telephone (Use Area Code)			
Same as Driver													<input type="checkbox"/>		<input type="checkbox"/>		<input type="checkbox"/>		<input type="checkbox"/>			
(50) Injury Severity / Type		OP Use		Air Bag Ejected		Extricated		Transported by		To Medical Facility				Property Type								
(51) Unit		Pos in Veh.		Last Name			First			Middle Initial			Date of Birth (mm/dd/yyyy)				Sex					
<input type="checkbox"/>	<input type="checkbox"/>	<input type="checkbox"/>	<input type="checkbox"/>														<input type="checkbox"/>					
<input type="checkbox"/>	<input type="checkbox"/>	<input type="checkbox"/>	<input type="checkbox"/>														<input type="checkbox"/>					
(52) Address													City		State		Zip		Telephone (Use Area Code)			
Same as Driver													<input type="checkbox"/>		<input type="checkbox"/>		<input type="checkbox"/>		<input type="checkbox"/>			
(53) Injury Severity / Type		OP Use		Air Bag Ejected		Extricated		Transported by		To Medical Facility				Property Type								
(54) Unit		Pos in Veh.		Last Name			First			Middle Initial			Date of Birth (mm/dd/yyyy)				Sex					
<input type="checkbox"/>	<input type="checkbox"/>	<input type="checkbox"/>	<input type="checkbox"/>														<input type="checkbox"/>					
<input type="checkbox"/>	<input type="checkbox"/>	<input type="checkbox"/>	<input type="checkbox"/>														<input type="checkbox"/>					
(55) Address													City		State		Zip		Telephone (Use Area Code)			
Same as Driver													<input type="checkbox"/>		<input type="checkbox"/>		<input type="checkbox"/>		<input type="checkbox"/>			
(56) Injury Severity / Type		OP Use		Air Bag Ejected		Extricated		Transported by		To Medical Facility				Property Type								
(57) Unit		Pos in Veh.		Last Name			First			Middle Initial			Date of Birth (mm/dd/yyyy)				Sex					
<input type="checkbox"/>	<input type="checkbox"/>	<input type="checkbox"/>	<input type="checkbox"/>														<input type="checkbox"/>					
<input type="checkbox"/>	<input type="checkbox"/>	<input type="checkbox"/>	<input type="checkbox"/>														<input type="checkbox"/>					
(58) Address													City		State		Zip		Telephone (Use Area Code)			
Same as Driver													<input type="checkbox"/>		<input type="checkbox"/>		<input type="checkbox"/>		<input type="checkbox"/>			
(59) Injury Severity / Type		OP Use		Air Bag Ejected		Extricated		Transported by		To Medical Facility				Property Type								
(60) Unit		Pos in Veh.		Last Name			First			Middle Initial			Date of Birth (mm/dd/yyyy)				Sex					
<input type="checkbox"/>	<input type="checkbox"/>	<input type="checkbox"/>	<input type="checkbox"/>														<input type="checkbox"/>					
<input type="checkbox"/>	<input type="checkbox"/>	<input type="checkbox"/>	<input type="checkbox"/>														<input type="checkbox"/>					
(61) Address													City		State		Zip		Telephone (Use Area Code)			
Same as Driver													<input type="checkbox"/>		<input type="checkbox"/>		<input type="checkbox"/>		<input type="checkbox"/>			
(62) Injury Severity / Type		OP Use		Air Bag Ejected		Extricated		Transported by		To Medical Facility				Property Type								
(63) Unit		Pos in Veh.		Last Name			First			Middle Initial			Date of Birth (mm/dd/yyyy)				Sex					
<input type="checkbox"/>	<input type="checkbox"/>	<input type="checkbox"/>	<input type="checkbox"/>														<input type="checkbox"/>					
<input type="checkbox"/>	<input type="checkbox"/>	<input type="checkbox"/>	<input type="checkbox"/>														<input type="checkbox"/>					
(64) Address													City		State		Zip		Telephone (Use Area Code)			
Same as Driver													<input type="checkbox"/>		<input type="checkbox"/>		<input type="checkbox"/>		<input type="checkbox"/>			
(65) Injury Severity / Type		OP Use		Air Bag Ejected		Extricated		Transported by		To Medical Facility				Property Type								
(66) Unit		Pos in Veh.		Last Name			First			Middle Initial			Date of Birth (mm/dd/yyyy)				Sex					
<input type="checkbox"/>	<input type="checkbox"/>	<input type="checkbox"/>	<input type="checkbox"/>														<input type="checkbox"/>					
<input type="checkbox"/>	<input type="checkbox"/>	<input type="checkbox"/>	<input type="checkbox"/>														<input type="checkbox"/>					
(67) Address													City		State		Zip		Telephone (Use Area Code)			
Same as Driver													<input type="checkbox"/>		<input type="checkbox"/>		<input type="checkbox"/>		<input type="checkbox"/>			
(68) Injury Severity / Type		OP Use		Air Bag Ejected		Extricated		Transported by		To Medical Facility				Property Type								

OFFICIAL OKLAHOMA TRAFFIC COLLISION REPORT
DIAGRAM SUPPLEMENTAL

Case Number _____

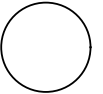

Indicate North
by Arrow

A large grid area for drawing a diagram, consisting of a 30x40 grid of small squares.

Example Hazardous Materials Crash Reporting Form,

U.S. Department of Transportation Materials
Transportation Bureau

APPENDIX

D



Hazardous Materials Incident Report

According to the Paperwork Reduction Act of 1995, no persons are required to respond to a collection of information unless it displays a valid OMB control number. The valid OMB control number for this information collection is 2137-0039. The filling out of this information is mandatory and will take 96 minutes to complete.

INSTRUCTIONS: Submit this report to the Information Systems Manager, U.S. Department of Transportation, Pipeline and Hazardous Materials Safety Administration, Office of Hazardous Materials Safety, DHM-63, Washington, D.C. 20590-0001. If space provided for any item is inadequate, use a separate sheet of paper, identifying the entry number being completed. Copies of this form and instructions can be obtained from the Office of Hazardous Materials Website at <http://hazmat.dot.gov>. If you have any questions, you can contact the Hazardous Materials Information Center at 1-800-HMR-4922 (1-800-467-4922) or online at <http://hazmat.dot.gov>.

PART I - REPORT TYPE

1. This is to report: A) A hazardous material incident B) An undeclared shipment with no release
 C) A specification cargo tank 1,000 gallons or greater containing any hazardous materials that
 (1) received structural damage to the lading retention system or damage that requires repair to a system intended to protect the lading retention system and (2) did not have a release.
2. Indicate whether this is: An initial report A supplemental (follow-up) report Additional Pages

PART II - GENERAL INCIDENT INFORMATION

3. Date of Incident: _____ 4. Time of Incident (use 24-hour time): _____
5. Enter National Response Center Report Number (if applicable): _____
6. If you submitted a report to another Federal DOT agency, enter the agency and report number: _____
7. Location of Incident: City: _____ County: _____ State: _____ ZIP Code (if known): _____
 Street Address/Mile Marker/Yardname/Airport/Body of Water/River Mile _____
8. Mode of Transportation Air Highway Rail Water
9. Transportation Phase In Transit Loading Unloading In Transit Storage
10. Carrier/Reporter Name _____
 Street _____
 City _____ State _____ ZIP Code _____
 Federal DOT ID Number _____ Hazmat Registration Number _____
11. Shipper/Offeror Name _____
 Street _____
 City _____ State _____ ZIP Code _____
 Waybill/Shipping Paper _____ Hazmat Registration Number _____
12. Origin (if different from shipper address) Street _____
 City _____ State _____ ZIP Code _____
13. Destination Street _____
 City _____ State _____ ZIP Code _____
14. Proper Shipping Name of Hazardous Material: _____
15. Technical/Trade Name: _____
16. Hazardous Class/ Division: _____ 17. Identification Number: _____ (E.g. UN2764, NA 2020)
 18. Packing Group: _____ (if applicable) 19. Quantity Released: _____ (Include Measurement Units)
20. Was the material shipped as a hazardous waste? Yes No If yes, provide the EPA Manifest Number: _____
21. Is this a Toxic by Inhalation (TIH) material? Yes No If yes, provide the Hazard Zone: _____
22. Was the material shipped under an Exemption, Approval, or Competent Authority Certificate? Yes No
 If yes, provide the Exemption, Approval, or CA number: _____
23. Was this an undeclared hazardous materials shipment? Yes No

PART III - PACKAGING INFORMATION

24. Check Packaging Type (check only one - if more than one, list type of packaging, copy Part III, and complete for each type:

- | | | | |
|-----------------------------------|------------------------------|--|--------------------------------------|
| <input type="checkbox"/> Non-bulk | <input type="checkbox"/> IBC | <input type="checkbox"/> Cargo tank Motor Vehicle (CTMV) | <input type="checkbox"/> Tank Car |
| <input type="checkbox"/> Cylinder | <input type="checkbox"/> RAM | <input type="checkbox"/> Portable Tank | <input type="checkbox"/> Other _____ |

25. See instructions and enter the appropriate failure codes found at the end of the instructions. Be sure to enter the codes from the list that corresponds to the particular packaging type checked above. Enter the number of codes as appropriate to describe the incident. Enter the most important failure point in line 1. If there are more than two failure points, provide in this format in part VI.

1. What Failed: _____	How Failed: _____	Causes of Failure: _____
2. What Failed: _____	How Failed: _____	Causes of Failure: _____

26a. Provide the packaging identification markings, if available.

Identification Markings: _____
 (Examples: 1A1/Y1.4/150/92/USA/RB/93/RL, UN31H1/Y0493/USA/M9339/10800/1200, DOT - 105A - 100W (RAIL), DOT 406 (HIGHWAY), DOT 51, DOT 3-A)

26b. For Non-bulk, IBC, or non-specification packaging, if identification markings are incomplete or unavailable, see instructions and complete the following:

Single Package or Outer Packaging:	Single Package or Inner Packaging (if any):
Packaging Type: _____	Packaging Type: _____
Material of Construction: _____	Material of Construction: _____
Head Type (Drums only): <input type="checkbox"/> Removable <input type="checkbox"/> Non - Removable	

27. Describe the package capacity and the quantity:

Single Package or Outer Packaging:	Single Package or Inner Packaging (if any):
Package Capacity: _____	Package Capacity: _____
Amount in Package: _____	Amount in Package: _____
Number in Shipment: _____	Number in Shipment: _____
Number Failed: _____	Number Failed: _____

28. Provide packaging construction and test information, as appropriate:

Manufacturer: _____	Manufacture Date: _____
Serial Number: _____	Last Test Date: _____
Material of Construction: _____	(if Tank Car, CTMV, Portable Tank, or Cylinder)
Design Pressure: _____	(if Tank Car, CTMV, Portable Tank)
Shell Thickness: _____	(if Tank Car, CTMV, Portable Tank)
Head Thickness: _____	(if Tank Car, CTMV)
Service Pressure: _____	(if Cylinder)
If valve or device failed:	
Type: _____	Manufacturer: _____ Model: _____
	(if present and legible) (if present and legible)

29. If the packaging is for Radioactive Materials, complete the following:

Packaging Category:	<input type="checkbox"/> Type A	<input type="checkbox"/> Type B	<input type="checkbox"/> Type C	<input type="checkbox"/> Excepted	<input type="checkbox"/> Industrial
Packaging Certification:	<input type="checkbox"/> Self Certified	<input type="checkbox"/> U.S. Certification	Certification Number _____		
Nuclide(s) Present: _____	Transport Index: _____				
Activity: _____	Critical Safety Index: _____				

PART IV - CONSEQUENCES

30. Result of Incident (check all that apply): Spillage Fire Explosion Material Entered Waterway/Storm Sewer
 Vapor (Gas) Dispersion Environmental Damage No Release

31. Emergency Response : The following entities responded to the incident: (Check all that apply)
 Fire/EMS Report # _____ Police Report # _____ In-house cleanup Other Cleanup

32. Damages: Was the total damage cost more than \$500? Yes No
If yes, enter the following information: If no, go to question 33.
Material Loss: \$ _____ Carrier Damage: \$ _____ Property Damage: \$ _____ Response Cost: \$ _____ Remediation/Cleanup Cost: \$ _____
(See damage definitions in the instructions)

33a. Did the hazardous material cause or contribute to a human fatality? Yes No
If yes, enter the number of fatalities resulting from the hazardous material:
Fatalities: Employees _____ Responders _____ General Public _____

33b. Were there human fatalities that did not result from the hazardous material? Yes No If yes, how many? _____

34. Did the hazardous material cause or contribute to personal injury? Yes No
If yes, enter the number of injuries resulting from the hazardous material:
Hospitalized (Admitted Only): Employees _____ Responders _____ General Public _____
Non-Hospitalized: Employees _____ Responders _____ General Public _____
(e.g.: On site first aid or Emergency Room observation and release)

35. Did the hazardous material cause or contribute to an evacuation? Yes No
If yes, provide the following information:
Total number of general public evacuated _____ Total number of employees evacuated _____ Total Evacuated _____
Duration of the evacuation _____ (hours)

36. Was a major transportation artery or facility closed? Yes No If yes, how many? _____ (hours)

37. Was the material involved in a crash or derailment? Yes No
If yes, provide the following information: Estimated speed (mph): _____ Weather conditions: _____
Vehicle overturn? Yes No
Vehicle left roadway/track? Yes No

PART V - AIR INCIDENT INFORMATION (please refer to § 175.31 to report a discrepancy for air shipments)

38. Was the shipment on a passenger aircraft? Yes No
If yes, was it tendered as cargo, or as passenger baggage?
 Cargo Passenger baggage

39. Where did the incident occur (if unknown, check the appropriate box for the location where the incident was discovered)?
 Air carrier cargo facility Sort center Baggage area
 By surface to/from airport During flight During loading/unloading of aircraft

40. What phase(s) had the shipment already undergone prior to the incident? (Check all that apply)
 Shipment had not been transported Transported by air (first flight) Transport by air (subsequent flights)
 Initial transport by highway to cargo facility Transfer at sort center/cargo facility

PART VI - DESCRIPTION OF EVENTS & PACKAGE FAILURE

Describe the sequence of events that led to the incident and the actions taken at the time it was discovered. Describe the package failure, including the size and location of holes, cracks, etc. Photographs and diagrams should be submitted if needed for clarification. Estimate the duration of the release, if possible. Describe what was done to mitigate the effects of the release. Continue on additional sheets if necessary.

PART VII - RECOMMENDATIONS/ACTIONS TAKEN TO PREVENT RECURRENCE

Where you are able to do so, suggest or describe changes (such as additional training, use of better packaging, or improved operating procedures) to help prevent recurrence. Provide recommendations for improvement to hazardous materials transportation beyond the control of your individual company. Continue on additional sheets if necessary.

PART VIII- CONTACT INFORMATION

Contact's Name (Type or Print): _____	Telephone Number: () _____
Contact's Title: _____	Fax Number: () _____
Business Name and Address: _____	Hazmat Registration Number (if not already provided): _____
E-mail Address: _____	Date: _____
Preparer is: <input type="checkbox"/> Carrier <input type="checkbox"/> Shipper <input type="checkbox"/> Facility <input type="checkbox"/> Other _____	

List of Selected Accident Investigations, National Transportation Safety Board¹⁵³



153 Provided by George A. Black, National Transportation Safety Board (NTSB).

1. *Collision Between Metrolink Train 210 and Ford Crew Cab, Stake Bed Truck at Highway-Rail Grade Crossing, Burbank, California, January 6, 2003.* NTSB Number HAR-03/04, NTIS Number PB2003-916204.
2. *Collision Between Amtrak Train 97 and Molnar Worldwide Heavy Haul Company Tractor-Trailer Combination Vehicle at Highway-Rail Grade Crossing in Intercession City, Florida, November 17, 2000.* NTSB Number HAR-02/02, NTIS Number PB2002-916202.
3. *Collision of National Railroad Passenger Corporation (Amtrak) Train 59 With a Loaded Truck-Semitrailer Combination at a Highway/Rail Grade Crossing, Bourbonnais, Illinois, March 15, 1999.* NTSB Number RAR-02/01, NTIS Number PB2002-916301.
4. *Collision of CSXT Freight Train and Murray County School District School Bus at Railroad/Highway Grade Crossing, Conasauga, Tennessee, March 28, 2000.* NTSB Number HAR-01/03, NTIS Number PB2001-916203.
5. *Collision Between Metrolink Train 901 and Mercury Transportation, Inc., Tractor-Combination Vehicle at Highway-Railroad Grade Crossing, Glendale, California, January 28, 2000.* NTSB Number HAR-01/02, NTIS Number PB2001-916202.
6. *Collision of Northeast Illinois Regional Commuter Railroad Corporation (METRA) Train and Transportation Joint Agreement School District 47/155 School Bus at Railroad/Highway Grade Crossing, Fox River Grove, Illinois, October 25, 1995.* NTSB Number HAR-96/02, NTIS Number PB96-916202.
7. *Highway/Rail Grade Crossing Collision Near Sycamore, South Carolina, May 2, 1995.* NTSB Number HAR-96/01, NTIS Number PB96-916201.
8. *Collision of Amtrak Train No. 88 with Rountree Transport and Rigging Vehicle on CSX Transportation, Inc., Railroad Near Intercession City, Florida, November 30, 1993.* NTSB Number HAR-95/01, NTIS Number PB95-916201.
9. *Gasoline Tank Truck/Amtrak Train Collision and Fire, Fort Lauderdale, Florida, March 17, 1993.* NTSB Number HAR-94/01, NTIS Number PB94-916201.
10. *Collision Of Amtrak Passenger Train No. 708 on Atchison, Topeka And Santa Fe Railway with Tab Warehouse And Distribution Co. Tractor-Semitrailer, Stockton, California, December 19, 1989.* NTSB Number RHR-90/01, NTIS Number PB89-917007.
11. *Collision Of Isle Of Wight County, Virginia, School Bus with Chesapeake And Ohio Railway Company Freight Train, State Route 615, near Carrsville, Virginia, April 12, 1984.* NTSB Number HAR-85/02, NTIS Number PB85-916202.
12. *Collision Of Amtrak Train No. 88 with Tractor Lowboy Semitrailer Combination Truck, Rowland, North Carolina, August 25, 1983.* NTSB Number RHR-84/01, NTIS Number PB84-917005.
13. *Collision Of Florida East Coast Freight Train with Indian River Academy School Bus, Port St. Lucie, Florida, September 27, 1984.* NTSB Number RHR-85/01, NTIS Number PB85-17007.

* Note: Refer to the NTSB Website for reports (www.ntsb.gov/Publictn/R_Acc.htm).

APPENDIX F

New Hampshire Hazard Index,

NCHRP Report 50 Accident Prediction Formula,
Peabody-Dimmick Accident Prediction Formula

The New Hampshire Index is as follows:

$$HI = (V) (T) (P_f) \quad (1)$$

where:

- HI = hazard index
- V = annual average daily traffic
- T = average daily train traffic
- P_f = protection factor
 - = 0.1 for automatic gates
 - = 0.6 for flashing lights
 - = 1.0 for signs only

Several modifications of the New Hampshire Index are in use. Some states use various other values for P_f as follows:

- 0.13 or 0.10 for automatic gates.
- 0.33, 0.20, or 0.60 for flashing lights.
- 0.67 for wigwags.
- 0.50 for traffic signal preemption.
- 1.00 for crossbucks.

One state adds 1 to average daily train traffic (T). Several states use a hazard index that basically incorporates the New Hampshire Index but also includes other factors:

- Train speed.
- Highway speed.
- Sight distance.
- Crossing angle.
- Crossing width.
- Type of tracks.
- Surface type.
- Population.
- Number of buses.
- Number of school buses.
- Number of tracks.
- Surface condition.
- Nearby intersection.
- Functional class of highway.

- Vertical alignment.
- Horizontal alignment.
- Number of hazardous material trucks.
- Number of passengers.
- Number of accidents.

Some of these hazard indices are shown in the following table:

$$1: HI = (V)(2T_f)(T_s) \frac{(SD + AN + NTR)}{4}$$

$$2: HI = \frac{(V)(T)(A_s)}{P_f}$$

$$3: HI = (V)(T) \frac{(TT + TTR + SD + AN + AL + L + G + VSD + W + LI)}{100}$$

$$4: HI = \frac{(P_f)(V_f)(T)(TS)(NTR)}{160} + (70A_a)^2 + 1.2(SD); A_a = \left(V + \frac{SBP}{1.2} \right) (HM)$$

$$5: HI = .1(P_f)(A_f)(T_f) + (AN)(NTR)(S)(.5L) + TS(FC \times P) + \left(\frac{V \times T}{10,000} \right) + SB$$

$$6: HI = \frac{(V_f)(P_f)(T)}{TR + TN + T_f + HS + G + SD + AN}$$

$$7: HI = (.01)(V)(T) + (.1)(HS)(TS) + (SD)(AN)(TR)(NTR)(AL) + (A_a^2 + 1)(RF)(LP)(P_f) + (SB)(SBP) + (10)(HM)$$

$$8: HI = \frac{\sqrt{(V)}(T)}{P_f}$$

A _s = Number of accidents in five years	SBP = Number of school bus passengers
A _a = Number of accidents per year	P = Factor for population
A _f = Accident factor	P _f = Protection factor
AL = Factor for highway alignment	SD = Factor for sight distance
AN = Factor for approach angle	T = Average number of trains per day
FC = Factor for functional class	RF = Factor for rideability
G = Factor for approach grades	T _f = Number of fast trains
HI = Hazard Index	T _s = Number of slow trains
HM = Factor for hazardous materials vehicles	T _f = Train factor
HS = Factor for highway speed	TN = Factor for number of night trains
L = Factor for number of lanes	TR = Factor for number and type of tracks
LI = Factor for local interference	TS = Factor for train speeds
LP = Factor for local priority	TT = Factor for type of train movements
S = Factor for surface type	TTR = Factor for type of tracks
SB = Number of school buses	V = Annual average daily traffic
NTR = Factor for number of tracks	V _f = Factor for annual average daily traffic
	VSD = Factor for vertical sight distance
	W = Factor for crossing width

Source: Railroad-Highway Grade Crossing Handbook, Second Edition. Washington, DC: U.S. Department of Transportation, Federal Highway Administration, 1986.

National Cooperative Highway Research Program Report 50 Accident Prediction Formula

The hazard index presented in National Cooperative Highway Research Program (NCHRP) Report 50 can be expressed as a complex formula or reduced to a more simple equation of coefficients that are taken from a few tables and graphs. The simple formula for calculating the expected number of accidents per year is:

Expected Accident Frequency = A x B x Current Trains per Day	<u>EXAMPLE</u>																																								
	<u>ASSUME</u>																																								
<table border="1"> <tr> <th>Vehicles Per Day (10 yr. ADT)</th> <th>'A' Factor</th> </tr> <tr><td>250</td><td>.000347</td></tr> <tr><td>500</td><td>.000694</td></tr> <tr><td>1000</td><td>.001377</td></tr> <tr><td>2000</td><td>.002627</td></tr> <tr><td>3000</td><td>.003981</td></tr> <tr><td>4000</td><td>.005208</td></tr> <tr><td>5000</td><td>.006516</td></tr> <tr><td>6000</td><td>.007720</td></tr> <tr><td>7000</td><td>.009005</td></tr> <tr><td>8000</td><td>.010278</td></tr> <tr><td>9000</td><td>.011435</td></tr> <tr><td>10000</td><td>.012674</td></tr> <tr><td>12000</td><td>.015012</td></tr> <tr><td>14000</td><td>.017315</td></tr> <tr><td>16000</td><td>.019549</td></tr> <tr><td>18000</td><td>.021736</td></tr> <tr><td>20000</td><td>.023877</td></tr> <tr><td>25000</td><td>.029051</td></tr> <tr><td>30000</td><td>.034757</td></tr> </table>	Vehicles Per Day (10 yr. ADT)	'A' Factor	250	.000347	500	.000694	1000	.001377	2000	.002627	3000	.003981	4000	.005208	5000	.006516	6000	.007720	7000	.009005	8000	.010278	9000	.011435	10000	.012674	12000	.015012	14000	.017315	16000	.019549	18000	.021736	20000	.023877	25000	.029051	30000	.034757	Urban area Crossbucks 5000 vehicles per day 5 trains per day <u>EXPECTED ACCIDENT FREQUENCY</u> EAF = .006516 x 3.06 x 5 EAF = 0.10 EAF = 1 accident every ten years Accident frequency is greater than 0.02. This would indicate need for higher type device Try flashing lights B = .23 EAF = .006516 x .23 x 5 EAF = 0.01 THEREFORE FLASHING LIGHTS ARE WARRANTED
Vehicles Per Day (10 yr. ADT)	'A' Factor																																								
250	.000347																																								
500	.000694																																								
1000	.001377																																								
2000	.002627																																								
3000	.003981																																								
4000	.005208																																								
5000	.006516																																								
6000	.007720																																								
7000	.009005																																								
8000	.010278																																								
9000	.011435																																								
10000	.012674																																								
12000	.015012																																								
14000	.017315																																								
16000	.019549																																								
18000	.021736																																								
20000	.023877																																								
25000	.029051																																								
30000	.034757																																								
'B' FACTOR COMPONENTS ('B' FACTOR BASIC VALUE ADJUSTMENTS) BASIC VALUES FOR EXISTING DEVICES																																									
A	Crossbucks, highway volume less than 500 per day	3.89																																							
B	Crossbucks, urban	3.06																																							
C	Crossbucks, rural	3.08																																							
D	Stop signs, highways volume less than 500 per day	4.51																																							
E	Stop signs	1.15																																							
F	Wigwags	0.61																																							
G	Flashing lights, urban	0.23																																							
H	Flashing lights, rural	0.93																																							
I	Gates, urban	0.08																																							
J	Gates, rural	0.19																																							

Source: Railroad-Highway Grade Crossing Handbook, Second Edition. Washington, DC: U.S. Department of Transportation, Federal Highway Administration, 1986.

NCHRP 50 also provides formulae for estimating the number of non-train-involved accidents per year as follows:

Automatic gates:

$$x = 0.00866 + 0.00036 \text{ (ADT)}, \text{ or} \tag{2}$$

$$EA = \frac{\text{ADT}}{100} [0.00866 + 0.00036 \text{ (ADT)}]$$

All other traffic control devices:

$$x = 0.00499 + 0.00036 \text{ (ADT)}, \text{ or} \tag{3}$$

$$EA = \frac{\text{ADT}}{100} [0.00499 + 0.00036 \text{ (ADT)}]$$

where:

- X = probability of coincidental vehicle and train arrival scaled by 10-3
- ADT = average daily traffic
- EA = expected number of accidents per year

Modifications of the hazard index exist. State's formula is:

$$\frac{\text{NCHRP 50 Hazard Index}}{\text{Site Evaluation} + \text{ACC/Yr}} \tag{4}$$

The Site Evaluation factor is based on the following:

- Most restrictive sight distance of all quadrants.
- Distance from crossing to business or crossroad.
- Crossing angle.
- Distraction from traffic control devices.
- People factor.

Each factor is rated from 1 (best) through 5 (worst), and the average of the 5 factors is used in the formula.

Peabody-Dimmick Accident Prediction Formula

The Peabody-Dimmick Formula, published in 1941, was based on five years of accident data from 3,563 rural crossings in 29 states. It is sometimes referred to as the Bureau of Public Roads formula. The formula used to determine the expected number of accidents in five years is:

$$A_5 = 1.28 \frac{(V^{0.170})(T^{0.151})}{P^{0.171}} + K \tag{5}$$

where:

- A₅ = expected number of accidents in five years
- V = annual average daily traffic
- T = average daily train traffic
- P = protection coefficient
- K = additional parameter

Several states, such as Florida, have developed their own formulae.

A_0 can be determined from a set of curves as shown below:

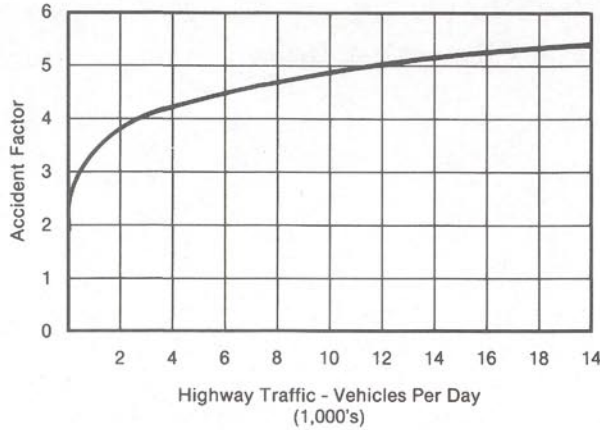

Figure 13a. Relation Between Highway Traffic and Accident Factor, V^a

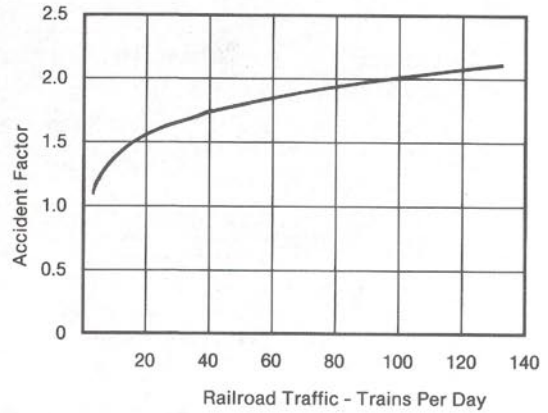

Figure 13b. Relation Between Railroad Traffic and Accident Factor, T^b

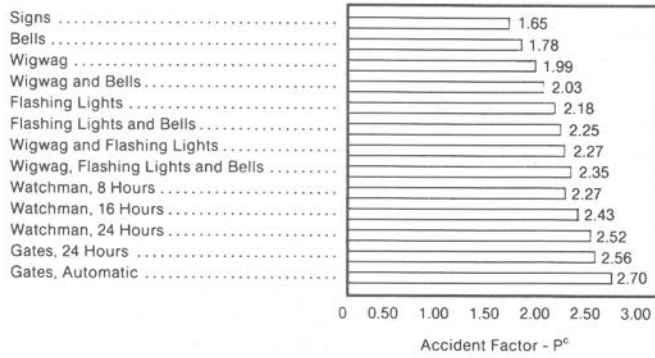
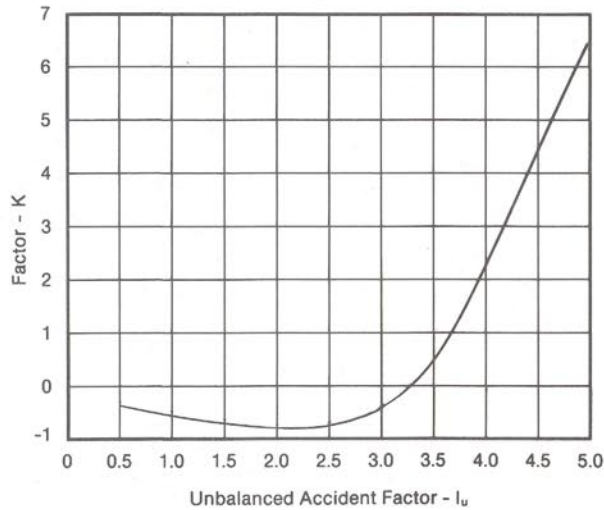

Figure 13c. Relation Between Warning Device and Accident Factor, P^c



The basic form of the equation for use with these curves is:

$$1.28 \frac{V^a \times T^b}{P^c} + K$$

EXAMPLE: Assume a crossing has an AADT of 3,442 vehicles, an average train traffic of 22 trains per day, and is equipped with wigwags. From Figure 13a, the factor due to highway traffic of 3,442 vehicles per day is found to be 3.99. From Figure 13b, the factor due to train traffic of 22 trains per day is found to be 1.59, and from Figure 13c, the factor for wigwags is found to be 1.99. Substituting these factors into the equation, it is found that the hazard index is equal to:

$$1.28 \frac{3.99 \times 1.59}{1.99} + K \quad \text{or,} \quad 4.08 + K.$$

From Figure 13d, K is determined to be + 2.58 for a value of I_u of 4.08 and, with this value for the parameter, the expected number of accidents in 5 years is 6.66.

Source: Railroad-Highway Grade Crossing Handbook, Second Edition. Washington, DC: U.S. Department of Transportation, Federal Highway Administration, 1986.

Florida Department of Transportation Accident Prediction Model

The Florida State University developed an accident prediction model for the Florida Department of Transportation. The model was developed using stepwise regression analysis, transformation of data, dummy variables, and transformation of the accident prediction model to its original scale. The resulting model is:

$$1. t_p = -8.075 + .318 \ln S_t + .484 \ln T + .437 \ln A +$$

$$.387 \ln V_v + (.28 - .28 \frac{MASD}{RSSD})^{**} +$$

$$(.33 - 1.23 \frac{MCSD}{RSSD})^* + .15 \text{ (no crossbucks)}$$

$$1a. y = \exp (.968t_p + 1.109) / 4$$

$$2. t_a = -8.075 + .318 \ln S_t + .166 \ln T + .293 \ln A +$$

$$.387 \ln V_v + (.28 - .28 \frac{MASD}{RSSD}) +$$

$$.225 (L - 2)^{**} - .233 \text{ (gates)}$$

(6)

$$2a. y = \exp (.938t_a + 1.109) / 4$$

where:

A = vehicles per day or annual average daily traffic

L = number of lanes

\ln = logarithm to the base e

MASD = actual minimum stopping sight distance along highway

MCSD = clear sight distance (ability to see approaching train along the highway, recorded for the four quadrants established by the intersection of the railroad tracks and road)

RSSD = required stopping sight distance on wet pavement

S_t = maximum speed of train

T = yearly average of the number of trains per day

t_a = \ln of predicted number of accidents in four-year period at crossings with active traffic control devices

t_p = \ln of predicted number of accidents in four-year period at crossing with passive traffic control devices

V_v = posted vehicle speed limit unless geometrics dictate a lower speed

y = predicted number of accidents per year at crossing

The predicted number of accidents per year, y, is adjusted for accident history as follows:

$$Y = y\sqrt{H/(y)(P)} \tag{7}$$

where:

Y = accident prediction adjusted for accident history

y = accident prediction based on the regression model

H = number of accidents for six-year history or since year of last improvement

P = number of years of the accident history period

A simple method of rating each crossing from zero to 90 was derived based mathematically on the accident prediction. This method, entitled Safety (Hazard) Index, is used to rank each crossing. A Safety Index of 70 is considered safe (no further improvement necessary). A Safety Index of 60, or one accident every nine years, would be considered marginal. The Safety Index is calculated as follows:

$$R = X(1 - \sqrt{Y}) \tag{8}$$

where:

R = safety index

Y = adjusted accident prediction value

X = 90 when less than 10 school buses per day traverse the crossing

= 85 when 10 or more school buses per day and active traffic control devices exist without gates

= 80 when 10 or more school buses per day and passive traffic control devices exist

* This variable is omitted if crossing is flagged or the circulation is less than zero.

** This variable is omitted if sight restriction is due to parallel road.

*** This variable is omitted when gates are present.

Diagnostic Team Crossing Evaluation Reports, Examples from States

APPENDIX

G

**PRELIMINARY DOCUMENT
NOT FOR RELEASE PURSUANT TO 23 U.S.C. SECTION 409**

OFFICE USE ONLY

MINIMUM WARNING TIME
20 seconds Minimum Time (MT)
seconds Clearance Time (CT)
seconds Minimum Warning Time (MWT)
seconds Buffer Time (BT)
seconds Equipment Response Time (ERT)
seconds Advance Traffic Signal Preemption Time (APT)
seconds TOTAL APPROACH TIME

_____ Average Daily Traffic (ADT) _____ Special Vehicle moves _____ MPH
_____ through trains at _____ mph per day _____ switch moves at _____ mph per day

Salvaged equipment: YES NO

Total estimated cubic yards of fill material:

- This project is actual cost for reimbursement of payment to the Railroad Company as agreed to by:
- This project is lump sum cost for reimbursement of payment to the Railroad Company as agreed to by:

TxDOT: _____ Railroad Company: _____

- Existing cross bucks meet TMUTCD guidelines
- Existing cross bucks do not meet TMUTCD guidelines and need to be replaced repaired. If replacement or repair is needed the railroad company or its contractor will make necessary arrangements, within 30 days of diagnostic
Notify TRF/RR when discrepancies are correct

- RxR pavement markings are to be installed, per the guidelines in the TMUTCD
- No RxR pavement markings are to be installed because
- Stop bars are to be installed, per the guidelines in the TMUTCD
- No stop bars are to be installed because

- Side lights are to be installed at this location. (Crossing is 50 feet or less from the parallel roadway)
- No side lights will be installed at this location. (Crossing is greater than 50 feet from the parallel roadway)

- AC power service is available at this location
- AC power service is not available at this location

- A signalized intersection is located _____ ft from crossing. Distance measured from the warning device to the edge of road/shoulder.
Attach copy of the preemption form
- No signalized intersection at this location

- Letter to proceed with project development was given to the Railroad Company
- No letter to proceed with project development was given to the Railroad Company because

- No yield or stop signs are to be installed by the State because
- Yield signs were recommended by the diagnostic team on an interim basis, per the guidelines in the TMUTCD. The local road authority was notified at Diagnostic. will be notified in writing. Yield signs to be installed within 30 days of diagnostic.
Notify TRF/RR when signs are installed

- Stop signs were recommended by the diagnostic team on an interim basis, per the guidelines in the TMUTCD. The local road authority was notified at Diagnostic. will be notified in writing. Stop signs to be installed within 30 days of diagnostic.
Notify TRF/RR when signs are installed

- Memo to install signs given to the district

DIAGNOSTIC TEAM

PROJECT INFORMATION

COUNTY: _____
 DOT No.: _____
 CONTROL: _____
 PROJECT: _____
 LOCATION: _____

RAILROAD: _____
 MILEPOST: _____

Date of Inspection: _____
 Date Layout Due: _____

**PRELIMINARY DOCUMENT
NOT FOR RELEASE PURSUANT TO 23 U.S.C. SECTION 409**

GENERAL NOTES

1. Signal circuits are designed to give 20 seconds Minimum Warning Time prior to the arrival of the fastest train at this crossing. Refer to signal circuit layout for total approach time.
2. **Constant warning** **Phase motion** **C Style /AC-DC** _____ circuits are to be used at this location. Upgrades required; _____ for circuit compatibility.
3. Conduit, fill dirt and crushed cover rock to be furnished in place by the Railroad Company or its Contractor at state's expense.
4. The Railroad Company or its Contractor will remove the existing **cross bucks** **mast flashers** **cantilevers** and dispose of the foundations.
5. The State or its Contractor will furnish and install or replace the appropriate pavement markings as outlined on the attached layout and standard sheet and in accordance with the guidelines in the Texas Manual on Uniform Traffic Control Devices.
6. The State or its Contractor will furnish and install or replace the following signs in accordance with the guidelines in the Texas Manual on Uniform Traffic Control Devices (TMUTCD) and the Standard Highway Sign Designs Manual for Texas(SHSD): _____ea.(W10-1), _____ea.(W10-2), _____ea.(W10-3), _____ea.(W10-4), _____ea.(R15-4). Additional signs to be added. _____
7. The **State** **County** **City** agrees to maintain the pavement markings and advance warning signs placed along the roadways under their jurisdiction in accordance with the guidelines in the Texas Manual on Uniform Traffic Control Devices and as shown on the layout and standard sheets as acknowledged on the Title Sheet.
8. The Railroad Company or its Contractor shall furnish, install and maintain sign mounting brackets for the report sign (R15-4) at the States expense.
9. The Railroad Company or its Contractor shall stencil the DOT-AAR numbers on the signal masts facing the adjacent roadway in 2" black lettering.
10. The **State** **County** **City** agrees to trim and maintain trees and vegetation for adequate visibility of the crossing signals and advance warning signs as acknowledged on the Title Sheet.
11. The Railroad Company or its Contractor will provide traffic control in accordance with the guidelines in the Texas Manual on Uniform Traffic Control Devices.
12. The **State** **Railroad Company** or its Contractor will install metal beam guard fence as shown on the layout, at the **State's** **Railroads** expense.
13. The **State** **Railroad Company** or its Contractor will install retaining wall as shown on the layout, at the **State's** **Railroads** expense.
14. The Railroad or its Contractor will furnish and install a relay to provide **simultaneous** **advance preemption** to **existing traffic signal** **proposed traffic signal** **advance flasher**. Normally a closed circuit is required between the control relay of the grade crossing warning device and the traffic signal controller or flasher as stated in the Texas Manual on Uniform Traffic Control Devices.



W10-1



W10-2



W10-3



W10-4

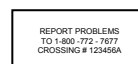

R15-4



R15-2



R8-8

ADDITIONAL NOTES

DESCRIPTION OF PROJECT

_____ Complete gate assemblies with _____ gate arm
 _____ Complete cantilever assemblies with _____ foot arm
 _____ Ea. R15-2, (_____ Tracks)

12" lamp housing shall be used and equipped with LED's (light emitting diodes), operated at not less than 8.5 volts under normal operating conditions.

**STATE OF NEVADA DEPARTMENT OF TRANSPORTATION
RAILROAD SAFETY DIAGNOSTIC REVIEW FORM – QUIET ZONES**

TEAM MEMBER: _____		AGENCY: _____		REVIEW DATE: _____	
CROSSING DATA			HIGHWAY DATA		
DOT Number: _____			Location: _____		
Railroad Company: _____			Road Speed: Posted _____ Realistic 85 th Percentile _____		
Railroad Milepost: _____			Highway AADT: _____		
Train Speed: Passenger _____ Freight _____			School Bus AADT: _____		
Track Class: _____			Highway Function Class: _____		
Number of Tracks & Type: _____			Principal Arterial or U.S. Route? <input type="checkbox"/> Yes <input type="checkbox"/> No		
Number of Trains: Passenger _____ Freight _____			Transit Buses: <input type="checkbox"/> Yes <input type="checkbox"/> No		
Crash History: Property Damage _____ Injury _____ Fatality _____			Hazmat Vehicles: <input type="checkbox"/> Yes <input type="checkbox"/> No		
			Commercial Vehicles: <input type="checkbox"/> Yes <input type="checkbox"/> No		
			National Highway System: <input type="checkbox"/> Yes <input type="checkbox"/> No		
Principal Rail Line: <input type="checkbox"/> Yes <input type="checkbox"/> No			Level of Service: <input type="checkbox"/> Design <input type="checkbox"/> Current		

TYPE OF EXISTING WARNING DEVICES AT CURRENT CROSSING

Automatic Gates:	2-Quad <input type="checkbox"/>	4-Quad <input type="checkbox"/>	Median <input type="checkbox"/>	Pedestrian Gates:	<input type="checkbox"/> Yes <input type="checkbox"/> No
Flashing Lights:	LED <input type="checkbox"/>	Bulbs <input type="checkbox"/>	Median <input type="checkbox"/>	Cantilever Flashing Lights:	<input type="checkbox"/> Yes <input type="checkbox"/> No
Crossbucks:	Double Faced <input type="checkbox"/>		Single Faced <input type="checkbox"/>	Bells:	<input type="checkbox"/> Gong <input type="checkbox"/> Electronic
Crossbucks Retroreflective 2-sided:	Yes <input type="checkbox"/>	No <input type="checkbox"/>		Emergency Notification	<input type="checkbox"/> Yes <input type="checkbox"/> No
Multi Track Sign: 2-Track <input type="checkbox"/>	3-Track <input type="checkbox"/>	4-Track <input type="checkbox"/>	6-Track <input type="checkbox"/>	STOP Signs:	<input type="checkbox"/> Yes <input type="checkbox"/> No
Advanced Warning Signs: W10-1 <input type="checkbox"/>	W10-2 <input type="checkbox"/>	W10-3 <input type="checkbox"/>	W10-4 <input type="checkbox"/>	Humpback W10-5 Sign	<input type="checkbox"/> Yes <input type="checkbox"/> No
Other Signs:	Sign Condition: _____				
Pavement Markings: Stop Bars <input type="checkbox"/> RxC <input type="checkbox"/> No Passing <input type="checkbox"/> Lane Lines <input type="checkbox"/> Dynamic Envelope <input type="checkbox"/> Other <input type="checkbox"/>					
Condition: _____					

DRIVER PERCEPTION

Overall awareness of railroad crossing, including visibility and effectiveness of possible signs, signals and markings.	<input type="checkbox"/> Acceptable <input type="checkbox"/> Recommend Improvement
Horizontal and vertical alignment considerations.	<input type="checkbox"/> Acceptable <input type="checkbox"/> Recommend Improvement
Sight Distance 1: <i>Distance to see xing.</i> North/East Side of Xing _____ South/West Side of Xing _____	<input type="checkbox"/> Acceptable <input type="checkbox"/> Recommend Improvement
Sight Distance 2: <i>Need _____' down tracks from _____' down road.</i> North/East Side Looking East/North _____ Looking West/South _____ South/West Side Looking East/North _____ Looking West/South _____	<input type="checkbox"/> Acceptable <input type="checkbox"/> Recommend Improvement
Sight Distance 3: <i>Distance down road to see _____' down tracks if #2 not acceptable.</i> North/East Side Looking East/North _____ Looking West/South _____ South/East Side Looking East/North _____ Looking West/South _____	<input type="checkbox"/> Acceptable <input type="checkbox"/> Recommend Improvement
Sight Distance 4: <i>16' from rail at a stop need _____' down tracks.</i> North/East Side Looking East/North _____ Looking West/South _____ South/West Side Looking East/North _____ Looking West/South _____	<input type="checkbox"/> Acceptable <input type="checkbox"/> Recommend Improvement
Nighttime visibility, including ambient lighting.	<input type="checkbox"/> Acceptable <input type="checkbox"/> Recommend Improvement
Skew of Xing: _____° Does skew limit perception?	<input type="checkbox"/> Yes <input type="checkbox"/> No
Are there simultaneous train movements on multiple tracks? Can standing boxcars blocking the view?	<input type="checkbox"/> Yes <input type="checkbox"/> No <input type="checkbox"/> Yes <input type="checkbox"/> No
Mitigation of inadequate perception: <input type="checkbox"/> Additional Signage: _____ <input type="checkbox"/> Luminaires Where: _____ <input type="checkbox"/> Automatic Warning Devices: _____ <input type="checkbox"/> Multiple Track Removal <input type="checkbox"/> Other: _____	
Do drivers/pedestrians violate warning devices? Describe: _____	<input type="checkbox"/> Yes <input type="checkbox"/> No

VERTICAL CURVE

Elevation Difference in 30' perpendicular to track: North/East _____" South/West _____"	<input type="checkbox"/> Acceptable <input type="checkbox"/> Recommend Improvement
Low clearance vehicles using crossing: <input type="checkbox"/> Low Boys <input type="checkbox"/> Bottom Dumps <input type="checkbox"/> Other Trucks <input type="checkbox"/> Farm Equipment Mitigation over 3 inches: <input type="checkbox"/> W10-5 <input type="checkbox"/> Detour Signage <input type="checkbox"/> Modify Approaches <input type="checkbox"/> Other: _____	

STORAGE/QUEUING

Nearest intersection: North/East _____ Name _____	South/West _____ Name _____
Are there signals the intersections within 1,000 feet?	<input type="checkbox"/> Yes <input type="checkbox"/> No
Is there adequate storage capacity to the North/East? If 'No' then how much is needed? _____	<input type="checkbox"/> Yes <input type="checkbox"/> No
Is there adequate storage capacity to the South/West? If 'No' then how much is needed? _____	<input type="checkbox"/> Yes <input type="checkbox"/> No
What mitigation is recommended for queuing?	

ADA/PEDESTRIANS/BICYCLES

Is there routine pedestrian and/or bicycle traffic?	<input type="checkbox"/> Yes <input type="checkbox"/> No
Is this a bike route or a proposed bike route? If proposed, when will it be constructed _____?	<input type="checkbox"/> Yes <input type="checkbox"/> No
If proposed bike route, determine if soon enough to be considered in project. <input type="checkbox"/> Yes <input type="checkbox"/> No Added width needed _____	
Bike lane needs: Width _____ Stripping: Lane Line _____ RxR _____ Bike Symbol _____ Signs: W10-1 AWS _____	
Bike Route or Trail: Width or Shoulder Width: _____ Signage: Bike Route: _____ Other: _____	
Is the sidewalk width adequate (36" is standard)?	<input type="checkbox"/> Yes <input type="checkbox"/> No
Are sidewalks or widening proposed? How wide? _____ When? _____ Consider in project? _____	<input type="checkbox"/> Yes <input type="checkbox"/> No
Are there curb cuts at nearby intersections and a clear path present to curb cuts at nearby intersections?	<input type="checkbox"/> Yes <input type="checkbox"/> No
Vertical obstructions (standard is none between 27" to 80" above ground).	<input type="checkbox"/> Yes <input type="checkbox"/> No
Slope of sidewalk transition (standard is 12:1 or less).	<input type="checkbox"/> Yes <input type="checkbox"/> No
Landing platform (standard is level and 5' x 5' or more).	<input type="checkbox"/> Yes <input type="checkbox"/> No
Surface smoothness (standard is wheelchair passable, no broken or buckled asphalt, edges < 1/4", etc.)	<input type="checkbox"/> Yes <input type="checkbox"/> No
Panel length (crossing surface panel needs to extend 1' behind back of sidewalk to be standard).	<input type="checkbox"/> Yes <input type="checkbox"/> No
Are flange gaps 2 1/2", or less, or flange fillers installed?	<input type="checkbox"/> Yes <input type="checkbox"/> No
Are crossing panels long enough (surface must minimum 1' past edge of walkway)?	<input type="checkbox"/> Yes <input type="checkbox"/> No
Can full flange fillers be used in low speed applications?	<input type="checkbox"/> Yes <input type="checkbox"/> No
Mitigation:	

HIGHWAY SECTION

Is there a nearby intersection within 1,000 feet of the crossing?	<input type="checkbox"/> Yes <input type="checkbox"/> No
Does the intersection warrant preempt control for the signals? See TWG Page 22.	<input type="checkbox"/> Yes <input type="checkbox"/> No
Are the advance warning signs in good condition?	<input type="checkbox"/> Yes <input type="checkbox"/> No
Is there adequate storage capacity?	<input type="checkbox"/> Yes <input type="checkbox"/> No
Is there a queuing problem? See queuing review above.	<input type="checkbox"/> Yes <input type="checkbox"/> No
Is the driver's attention being diverted?	<input type="checkbox"/> Yes <input type="checkbox"/> No
Is there an adequate approach landing platform?	<input type="checkbox"/> Yes <input type="checkbox"/> No
Can the road approach be adjusted?	<input type="checkbox"/> Yes <input type="checkbox"/> No
Are curb and gutter present?	<input type="checkbox"/> Yes <input type="checkbox"/> No
Does the crossing warrant highway guardrail (35 mph and above)?	<input type="checkbox"/> Yes <input type="checkbox"/> No
If guardrail is present, does it require upgrading?	<input type="checkbox"/> Yes <input type="checkbox"/> No
Guardrail end treatment: MBCT <input type="checkbox"/> BCT <input type="checkbox"/> Diaphragm <input type="checkbox"/> Parabolic Flare <input type="checkbox"/> Other <input type="checkbox"/>	
Are drainage culverts present? Size _____ Location _____	<input type="checkbox"/> Yes <input type="checkbox"/> No
Do culverts, drop inlets, etc. need to be adjusted?	<input type="checkbox"/> Yes <input type="checkbox"/> No
Utilities adjustment needed? Overhead Lines <input type="checkbox"/> Buried Lines <input type="checkbox"/> Gas Vent Riser <input type="checkbox"/>	<input type="checkbox"/> Yes <input type="checkbox"/> No
Roadway width _____ Number of Travel Lanes _____ Is Road Wide Enough? Yes/No Pavement Condition _____	
Development Type: Residential <input type="checkbox"/> Industrial <input type="checkbox"/> Commercial <input type="checkbox"/> Open Space <input type="checkbox"/> Institutional <input type="checkbox"/>	
Heavy Truck Use: Evaluate locating stop bar up to 50' from xing to give trucks time to gain speed & reduce time to clear xing or add flash time in Railroad Section.	
Stop Bar location: Feet from nearest rail North/East _____ South/West _____	

RAILROAD SECTION

Is the track on a curve? Degree of curve: _____ ° Super elevation: _____ " Cross level: _____ %	<input type="checkbox"/> Yes <input type="checkbox"/> No
Are active warning devices needed? Type of circuitry: AC-DC <input type="checkbox"/> CWT <input type="checkbox"/> MS <input type="checkbox"/>	<input type="checkbox"/> Yes <input type="checkbox"/> No
Do railroad signals give adequate warning time? How much time is there? _____ seconds. See TWG.	<input type="checkbox"/> Yes <input type="checkbox"/> No
Are active advance warning signs warranted? (Where stopping sight distance is inadequate.)	<input type="checkbox"/> Yes <input type="checkbox"/> No
Can multiple tracks be removed?	<input type="checkbox"/> Yes <input type="checkbox"/> No
Should interties be used? See TWG Page 22.	<input type="checkbox"/> Yes <input type="checkbox"/> No
Are presignals warranted? See TWG Page 24.	<input type="checkbox"/> Yes <input type="checkbox"/> No
Are barrier gates warranted? See review below.	<input type="checkbox"/> Yes <input type="checkbox"/> No
Does the track height need to be adjusted?	<input type="checkbox"/> Yes <input type="checkbox"/> No
Is the surface smooth?	<input type="checkbox"/> Yes <input type="checkbox"/> No
Is surface rehabilitation required to facilitate signal installation?	<input type="checkbox"/> Yes <input type="checkbox"/> No

STOP AND YIELD SIGNS

<i>THE FOLLOWING CONSIDERATIONS MUST BE MET IN EVERY CASE WHERE A STOP SIGN IS INSTALLED:</i>		
STOP or YIELD signs may be used by road authority if there are two or more TADT and xing is <i>passive</i> .	<input type="checkbox"/> Yes	<input type="checkbox"/> No
Will enforcement & judicial officials enforce STOP signs equally with roadway intersections?	<input type="checkbox"/> Yes	<input type="checkbox"/> No
Would installation of a STOP sign create a less dangerous situation than would exist with a YIELD sign?	<input type="checkbox"/> Yes	<input type="checkbox"/> No

<i>ANY OF THE FOLLOWING CONDITIONS INDICATE THAT A STOP SIGN MIGHT REDUCE RISK AT A CROSSING:</i>		
Maximum train speeds equal, or exceed, 30 mph.	<input type="checkbox"/> Yes	<input type="checkbox"/> No
Highway traffic mix includes buses, hazmat carriers and/or large trash or earth moving equipment.	<input type="checkbox"/> Yes	<input type="checkbox"/> No
Train movements are 10 or more per day, five or more days per week.	<input type="checkbox"/> Yes	<input type="checkbox"/> No
Is the rail line used by passenger trains?	<input type="checkbox"/> Yes	<input type="checkbox"/> No
The rail line is regularly used to transport a significant quantity of hazardous materials.	<input type="checkbox"/> Yes	<input type="checkbox"/> No
The highway crosses two or more tracks, particularly where both tracks are main tracks or one track is a passing siding that is frequently used.	<input type="checkbox"/> Yes	<input type="checkbox"/> No
The angle of approach to the crossing is skewed.	<input type="checkbox"/> Yes	<input type="checkbox"/> No
The line of sight from an approaching highway vehicle to an approaching train is restricted such that approaching traffic is required to substantially reduce speed.	<input type="checkbox"/> Yes	<input type="checkbox"/> No

STOP AND YIELD SIGNS

<i>THE FOLLOWING CONSIDERATIONS SHOULD BE WEIGHED AGAINST PLACING STOP SIGNS:</i>		
There are active warning devices.	<input type="checkbox"/> Yes	<input type="checkbox"/> No
Highway is other than secondary in character. Maximum 400 AADT - rural , 1,500 AADT - urban.	<input type="checkbox"/> Yes	<input type="checkbox"/> No
STOP sign would cause queuing onto nearby road.	<input type="checkbox"/> Yes	<input type="checkbox"/> No
The roadway is a steep ascending grade to or through the crossing, sight distance in both directions is unrestricted in relation to maximum closing speed, and heavy vehicles use the crossing. (SD4 is good.)	<input type="checkbox"/> Yes	<input type="checkbox"/> No

ACTIVE TURN RESTRICTION SIGNS

<i>AN ACTIVE TURN RESTRICTION SIGN (NO RIGHT/LEFT TURN) SHOULD BE DISPLAYED IF EITHER OF THE FOLLOWING:</i>		
There is parallel street within 50' of tracks where a turning vehicle could proceed around lowered gates.	<input type="checkbox"/> Yes	<input type="checkbox"/> No
A signalized intersection interconnected and preempted by the approach of a train and all existing turn movements toward railroad crossing should be prohibited.	<input type="checkbox"/> Yes	<input type="checkbox"/> No

REVIEW FOR FLASHING LIGHTS & AUTOMATIC GATES – MANDATORY FOR PUBLIC XINGS

<i>ACTIVE DEVICES WITH AUTOMATIC GATES SHOULD BE CONSIDERED AT CROSSINGS WHENEVER AN ENGINEERING STUDY BY A DIAGNOSTIC TEAM DETERMINES ONE OR MORE OF THE FOLLOWING CONDITIONS EXISTS:</i>		
Is the crossing on the National Highway System, U.S marked route or a principal arterial?	<input type="checkbox"/> Yes	<input type="checkbox"/> No
If inadequate sight distance exists in one or more quadrants and ALL of the following are 'Yes':		
a. Is it physically or economically unfeasible to correct the sight distance deficiency?	<input type="checkbox"/> Yes	<input type="checkbox"/> No
b. Is no acceptable alternate access available? If access exists, then close the crossing.	<input type="checkbox"/> Yes	<input type="checkbox"/> No
c. On a life cycle cost basis, would the cost of providing acceptable alternate access or grade separation exceed the cost of installing active devices with gates?	<input type="checkbox"/> Yes	<input type="checkbox"/> No
Do regularly scheduled passenger trains operate in close proximity to industrial facilities?	<input type="checkbox"/> Yes	<input type="checkbox"/> No
Is the crossing in close proximity to schools, industrial plants or commercial areas where there is higher than normal usage of school buses, heavy trucks or trucks carrying dangerous materials?	<input type="checkbox"/> Yes	<input type="checkbox"/> No
Based on the number of passenger trains and/or the number and type of trucks, does the diagnostic team consider the crossing a higher than normal risk that a train-vehicle collision could result in death or injury to rail passengers?	<input type="checkbox"/> Yes	<input type="checkbox"/> No
Are there multiple main or running tracks through the crossing?	<input type="checkbox"/> Yes	<input type="checkbox"/> No
Does the expected accident frequency (EAF) for active devices without gates exceed 0.1?	<input type="checkbox"/> Yes	<input type="checkbox"/> No
Does the traffic from a nearby highway intersection queue on or across the tracks?	<input type="checkbox"/> Yes	<input type="checkbox"/> No
Does the diagnostic team have other reasons?	<input type="checkbox"/> Yes	<input type="checkbox"/> No

OPTIONAL USE OF AUTOMATIC GATES – ONLY OPTIONAL AT PRIVATE XINGS

<i>ACTIVE DEVICES WITH AUTOMATIC GATES SHOULD BE CONSIDERED AS AN OPTION WHEN ECONOMICALLY THEY CAN BE JUSTIFIED AND WHEN ONE OR MORE OF THE FOLLOWING CONDITIONS EXISTS:</i>		
Do multiple tracks exist?	<input type="checkbox"/> Yes	<input type="checkbox"/> No
Are there 20 or more trains per day?	<input type="checkbox"/> Yes	<input type="checkbox"/> No
Does the posted highway speed exceed 40 mph in urban areas, or exceed 55 mph in rural areas?	<input type="checkbox"/> Yes	<input type="checkbox"/> No
Does the AADT exceed 2,000 in urban areas, or exceed 500 in rural areas?	<input type="checkbox"/> Yes	<input type="checkbox"/> No
Are there multiple lanes of traffic in the same direction of travel?	<input type="checkbox"/> Yes	<input type="checkbox"/> No
Does the product of the number of trains per day & AADT exceed 5,000 urban, or 4,000 rural?	<input type="checkbox"/> Yes	<input type="checkbox"/> No
Has an engineering study indicated the absence of active devices would result in the highway facility performing at a level of service below Level C?	<input type="checkbox"/> Yes	<input type="checkbox"/> No

Does the expected accident frequency (EAF) exceed 0.075?	<input type="checkbox"/> Yes	<input type="checkbox"/> No
Is this a new project or are the current active devices being replaced?	<input type="checkbox"/> Yes	<input type="checkbox"/> No
Does the diagnostic team have other reasons?	<input type="checkbox"/> Yes	<input type="checkbox"/> No

CANTILEVER FLASHING LIGHTS

Two or more lanes the same direction.	<input type="checkbox"/> Yes	<input type="checkbox"/> No
High speed highways regardless of number of lanes.	<input type="checkbox"/> Yes	<input type="checkbox"/> No
High percentage of truck traffic.	<input type="checkbox"/> Yes	<input type="checkbox"/> No
Objects on the side of the highway can obstruct the visibility of mast mounted flashing lights.	<input type="checkbox"/> Yes	<input type="checkbox"/> No
Horizontal or vertical curves or other topographical features obstruct the mast mounted flashing lights.	<input type="checkbox"/> Yes	<input type="checkbox"/> No
Trucks parked by roadside, blocking warning devices.	<input type="checkbox"/> Yes	<input type="checkbox"/> No

WARNING/BARRIER GATE SYSTEM

Crossings with passenger trains.	<input type="checkbox"/> Yes	<input type="checkbox"/> No
Crossing with high-speed trains.	<input type="checkbox"/> Yes	<input type="checkbox"/> No
Crossing in quiet zones.	<input type="checkbox"/> Yes	<input type="checkbox"/> No
Crossing in quiet zones with short medians.	<input type="checkbox"/> Yes	<input type="checkbox"/> No
As otherwise deemed necessary by the diagnostic review team. Describe.	<input type="checkbox"/> Yes	<input type="checkbox"/> No

PEDESTRIAN TREATMENTS

Can devices be designed to avoid stranding pedestrians between sets of tracks?	<input type="checkbox"/> Yes	<input type="checkbox"/> No
Can audible devices be added if determined necessary?	<input type="checkbox"/> Yes	<input type="checkbox"/> No
Would swing gates operate safely for disabled individuals?	<input type="checkbox"/> Yes	<input type="checkbox"/> No
Can the activation of gates, flashers and bells be delayed for a period of time at the crossing station using a Train to Wayside Controller to reduce traffic delays at LRV stations?	<input type="checkbox"/> Yes	<input type="checkbox"/> No
Are skirted gates or other warning devices needed?	<input type="checkbox"/> Yes	<input type="checkbox"/> No

CLOSURE

<i>CROSSING SHOULD BE CONSIDERED FOR CLOSURE WHEN ONE OR MORE OF THE FOLLOWING APPLY:</i>		
Does the crossing have nearby acceptable alternate vehicle and pedestrian access?	<input type="checkbox"/> Yes	<input type="checkbox"/> No
On a life cycle cost basis, would improvement exceed cost of providing acceptable alternate access?	<input type="checkbox"/> Yes	<input type="checkbox"/> No
If an engineering study determined any of the following:		
a. FRA Class 1,2, or 3 track with daily train movements		
1. AADT less than 500 in urban areas, acceptable alternate access within ¼ mile, and the median trip length would not increase by more than ½ mile.	<input type="checkbox"/> Yes	<input type="checkbox"/> No
2. AADT less than 50 in rural areas, acceptable alternate access within ½ mile, and the median trip length would not increase by more than 1½ miles.	<input type="checkbox"/> Yes	<input type="checkbox"/> No
b. FRA Class 4 or 5 track with active rail traffic.		
1. AADT less than 1,000 in urban areas, acceptable alternate access within ¼ mile and the median trip length would not increase by more than ¾ mile.	<input type="checkbox"/> Yes	<input type="checkbox"/> No
2. AADT less than 100 in rural areas, acceptable alternate access within 1 mile, and the trip median length would not increase more than 3 miles.	<input type="checkbox"/> Yes	<input type="checkbox"/> No
c. FRA Class 6 or higher track with active rail traffic.		
AADT less than 250 in rural areas, acceptable alternate access within 1½ miles, and the median trip length would not increase by more than 4 miles.	<input type="checkbox"/> Yes	<input type="checkbox"/> No
Does an engineering study determine the crossing should be closed because railroad operations will occupy or block the crossing for extended periods of time on a routine basis and it is not physically or economically feasible to grade separate or shift train operations to another location? Such locations would typically include the following areas:	<input type="checkbox"/> Yes	<input type="checkbox"/> No
a. Rail yards.		
b. Passing tracks primarily used for holding trains while waiting to meet or be passed by other trains.		
c. Locations where train crews are routinely required to stop trains because of cross traffic on intersecting lines, or switch cars.		
d. Switching leads at the ends of classification yards.		
e. Where trains are required to "double" in or out of yards and terminals.		
f. In the proximity of stations where long distance passenger trains are required to make extended stops to transfer baggage.		
g. Locations where trains must stop or wait for crew changes.		
If there are types of vehicle traffic that are required to stop and Sight Distance 4 is not sufficient and automatic warning devices cannot be installed.	<input type="checkbox"/> Yes	<input type="checkbox"/> No

GRADE SEPARATION

<i>CROSSING SHOULD BE CONSIDERED FOR GRADE SEPARATION WHEN ONE OR MORE OF THE FOLLOWING APPLY:</i>		
Is the highway part of the designated Interstate Highway System?	<input type="checkbox"/> Yes	<input type="checkbox"/> No
Is the highway designed to have full control access?	<input type="checkbox"/> Yes	<input type="checkbox"/> No
Does the highway posted speed exceed 70 mph?	<input type="checkbox"/> Yes	<input type="checkbox"/> No
Does the AADT exceed 100,000 in urban areas or 50,000 in rural areas?	<input type="checkbox"/> Yes	<input type="checkbox"/> No
Is the maximum authorized train speed over 110 mph?	<input type="checkbox"/> Yes	<input type="checkbox"/> No
Is there an average of 150 or more trains per day or 300 million gross tons per year?	<input type="checkbox"/> Yes	<input type="checkbox"/> No
Is there an average of 75 or more passenger trains per day in urban areas or 30 or more in rural?	<input type="checkbox"/> Yes	<input type="checkbox"/> No
Crossing exposure (product of trains per day & AADT) exceeds 1,000,000 in urban, 250,000 rural.	<input type="checkbox"/> Yes	<input type="checkbox"/> No
Passenger train exposure exceeds 800,000 in urban areas and 200,000 in rural areas?	<input type="checkbox"/> Yes	<input type="checkbox"/> No
The expected accident frequency (EAF) for active devices exceeds 0.5?	<input type="checkbox"/> Yes	<input type="checkbox"/> No
Vehicle delays exceed 40 vehicle hours per day?	<input type="checkbox"/> Yes	<input type="checkbox"/> No

GRADE SEPARATION

<i>CONSIDER CROSSINGS FOR GRADE SEPARATION WHEN ONE OR MORE APPLY AND LIFE CYCLE COSTS CAN BE FULLY ALLOCATED:</i>		
Is the highway part of the designated National Highway System?	<input type="checkbox"/> Yes	<input type="checkbox"/> No
Is the highway designed to have partial control access?	<input type="checkbox"/> Yes	<input type="checkbox"/> No
Does the highway posted speed exceed 55 mph?	<input type="checkbox"/> Yes	<input type="checkbox"/> No
Does the AADT exceed 50,000 in urban areas or 25,000 in rural areas?	<input type="checkbox"/> Yes	<input type="checkbox"/> No
Is the maximum authorized train speed over 100 mph?	<input type="checkbox"/> Yes	<input type="checkbox"/> No
Is there an average of 75 or more trains per day or 150 million gross tons per year?	<input type="checkbox"/> Yes	<input type="checkbox"/> No
Is there an average of 50 or more passenger trains per day in urban areas or 12 or more in rural?	<input type="checkbox"/> Yes	<input type="checkbox"/> No
Crossing exposure (product of trains per day & AADT) exceeds 500,000 in urban, 125,000 rural?	<input type="checkbox"/> Yes	<input type="checkbox"/> No
Passenger train exposure exceeds 400,000 in urban areas and 100,000 in rural areas?	<input type="checkbox"/> Yes	<input type="checkbox"/> No
The expected accident frequency (EAF) for active devices exceeds 0.2?	<input type="checkbox"/> Yes	<input type="checkbox"/> No
Vehicle delays exceed 30 vehicle hours per day?	<input type="checkbox"/> Yes	<input type="checkbox"/> No
Does the engineering study indicate that the absence of a grade separation will result in the highway facility performing at a level below service 10% or more of the time?	<input type="checkbox"/> Yes	<input type="checkbox"/> No

NEW CROSSINGS

<i>ONLY PERMITTED AT EXISTING RAILROAD TRACKS AT-GRADE WHEN ALL FOLLOWING APPLY & NOT ON MAINLINES:</i>		
On public highways or streets where there is a clear and compelling need (other than enhancing the value or development potential of the adjoining property).	<input type="checkbox"/> Yes	<input type="checkbox"/> No
Grade separation cannot be economically justified (benefit to cost ratio on a fully allocated cost basis is less than 1.0 (usually the crossing exposure exceeds 50,000 in urban areas & 25,000 in rural areas)	<input type="checkbox"/> Yes	<input type="checkbox"/> No
There are no other viable alternatives.	<input type="checkbox"/> Yes	<input type="checkbox"/> No
Rail operations will not block the crossing.	<input type="checkbox"/> Yes	<input type="checkbox"/> No

IF A CROSSING IS PERMITTED, THE FOLLOWING CONDITIONS SHOULD APPLY:

The crossing will be equipped with active devices with gates.	<input type="checkbox"/> Yes	<input type="checkbox"/> No
The plans and specifications should be subject to the approval of the highway agency having jurisdiction over the roadway (if other than a State agency), the State DOT and/or other State agency vested with the authority to approve new crossings, and the operating railroad.	<input type="checkbox"/> Yes	<input type="checkbox"/> No
All costs associated with the construction of the new crossing should be borne by the party or parties requesting the new crossing, including providing financially for the ongoing maintenance of the crossing surface and traffic control devices where no crossing closures are included in the project.	<input type="checkbox"/> Yes	<input type="checkbox"/> No
Whenever new public highway-rail crossings are permitted, they should fully comply with all applicable provisions of this proposed recommended practice.	<input type="checkbox"/> Yes	<input type="checkbox"/> No
Whenever a new highway-rail crossing is constructed, consideration should be given to closing one or more adjacent crossings.	<input type="checkbox"/> Yes	<input type="checkbox"/> No

QZ QUALIFICATIONS

PUBLIC CROSSINGS	PRIVATE CROSSINGS
<input type="checkbox"/> Public Authority Maintains 1+ Side of Crossing	<input type="checkbox"/> No Public Road Authority – Private Name: _____
<input type="checkbox"/> Freight Line Part of Main Rail System or Transit with Freight	<input type="checkbox"/> Freight Line Part of Main Rail System or Transit with Freight
<input type="checkbox"/> Crossing = Road + Walkways + Paths	<input type="checkbox"/> Crossing = Road + Walkways + Paths
<input type="checkbox"/> Minimum Length ½ Mile	<input type="checkbox"/> Minimum Length ½ Mile
<input type="checkbox"/> Party Responsible for Initial & Ongoing Costs _____	<input type="checkbox"/> Cannot Force Private Party to Pay. Who Will? _____
<input type="checkbox"/> Party Responsible for Private Costs _____	<input type="checkbox"/> Private w/Public Use = Whistle NRS705.43 = QZ Application
<input type="checkbox"/> Night Ban or <input type="checkbox"/> 24-Hour Ban?	<input type="checkbox"/> Night Ban or <input type="checkbox"/> 24-Hour Ban?
<input type="checkbox"/> Annual Review to New NSRT Needed?	<input type="checkbox"/> Annual Review to New NSRT Needed?
<input type="checkbox"/> Minimum Warning = Lights & Gates & No Train Horn Sign	<input type="checkbox"/> Minimum Warning = X-Buck & No Train Horn Sign

PRECONSTRUCTION MITIGATION

What interim measures are needed?
If improvements are needed but will not be done, document reasons.
If no improvement needed, document adequacy of current devices.

TYPE OF PROTECTION DURING CONSTRUCTION

<input type="checkbox"/> Detour with Flagger protection during the day.	<input type="checkbox"/> Combination daylight flagging and stop signs.
<input type="checkbox"/> 24 hour Flagger protection.	<input type="checkbox"/> Construction of half of crossing at a time with work zone detour.
<input type="checkbox"/> Reopen main crossing at night with existing protection.	<input type="checkbox"/> Temporary signal protection (only under stringent conditions).
<input type="checkbox"/> Work zone traffic control with lane closures and detours with railroad flagging during working hours.	
<input type="checkbox"/> Other:	

NEVADA PUBLIC UTILITY COMMISSION AUTHORITY REQUIRED FOR IMPROVEMENTS

<input type="checkbox"/> New Crossing	<input type="checkbox"/> All Automatic Warning Devices - Signal Installation, Circuitry, etc.
<input type="checkbox"/> Closure	<input type="checkbox"/> Surface Improvement, Install Prefab Crossing, etc.
<input type="checkbox"/> Relocation	<input type="checkbox"/> Passive Improvement, Signs, Markings, etc.
<input type="checkbox"/> Major Modification (track removal, road widening, etc.)	<input type="checkbox"/> Grade Separation
<input type="checkbox"/> Medians / Channelization	<input type="checkbox"/> Luminaires
<input type="checkbox"/> Pedestrian Amenities	<input type="checkbox"/> Other

Source: Nevada Department of Transportation.

State Crossing Consolidations and Closures

Overview

In the majority of states, the overall authority for highway-rail crossing safety and the authority to order the elimination of at-grade crossings lie with the state agency that regulates and oversees transportation.

In a small number of states, the responsibility for crossing elimination is vested in regulatory bodies. These are referred to by different names, including the public utility commission and the state corporation commission. A couple of states provide for shared responsibility between a state agency and a unit of local government. A few more provide for shared responsibility between the department of transportation and another state agency, such as the highway department.

The agency charged with the responsibility for elimination, or abolishment, as the process is often called, has not changed a great deal since the original publication of this handbook. In the few instances in which the responsible agency is different, it was the result of the powers and functions of the agency being assumed by another agency. For example, in Missouri, the agency originally responsible for grade crossing regulation was the Public Service Commission (PSC). The powers, functions, and duties of the PSC with respect to grade crossing safety were transferred to the Division of Motor Carriers and Railroad Safety in the Department of Economic Development. Massachusetts has renamed its agency responsible for grade crossings the Department of Telecommunications and Energy.

This appendix is intended to present a brief overview of the procedures for grade crossing elimination on a state-by-state basis. The state or county agency with statutory authority to order the elimination of a grade crossing is identified, along with an indication

of whether the authority is exclusive or shared. Each state's entry concerning the subject is followed by the appropriate citation(s). The information contained in this appendix comes from the third edition of "Compilation of State Laws and Regulations on Matters Affecting Highway- Rail Crossings," published by the Federal Railroad Administration in 1999 (www.fra.dot.gov).

State Laws and Regulations

Alabama

The Alabama Department of Transportation (ALDOT) has statutory authority to abandon and discontinue any portion of a state highway or street on a state highway route crossing the tracks or right of way of any railroad or street railway within the state, and to close the grade crossings, with the approval of the city council or governing body of any municipality, when, in its judgment, the grade crossing has ceased to be necessary for the public as part of any state highway because of relocation of the highway, the construction of an underpass or overpass, or other provision made for the elimination of the grade crossing.

With respect to at-grade crossings on a municipal or county highway, street, or right of way of any railroad within the state, whenever, if in the judgment of ALDOT, the grade crossing is dangerous, redundant, or the enhancement of public safety resulting from the closing outweighs any inconvenience caused by rerouting the vehicular traffic. Any such action to be taken by ALDOT concerning an at-grade crossing on a municipal or county highway must have the approval of the city or governing body. In the event any such closing is deemed by ALDOT to cause substantial inconvenience to vehicular traffic or to materially impair the provision of police, fire, or ambulance service, ALDOT may also

order a relocation of the crossing or the building of another crossing at another location.

Whenever ALDOT orders the closing of a grade crossing, it must enter its order in the department minutes. Notice in writing is given by ALDOT by posting a notice on each side of the railroad or street railway at the grade crossing for a period of 30 days. If the closing is a crossing on a county or municipal road, prior to issuing the order to close the crossing, ALDOT must also give notice of its intention to close to the affected municipality or county. In addition, ALDOT must publish legal notice of intention to close the crossing in a newspaper of general circulation in the county once per week for three consecutive weeks prior to the closure. The notice must outline the procedure to request a hearing. If there is such a request for a hearing, ALDOT must give 10 days' notice to the requester and the municipality or county. Ala. Code § 37-2-84 (a)-(b)-(c) (1999).

Alaska

Alaska has no code section relating to this topic.

Arizona

The Arizona Corporation Commission has the exclusive authority to alter or abolish highway-rail grade crossings within the state. This authority extends to crossings where railroad tracks cross public roads or streets of a town or city. Ariz. Rev. Stat. Ann. § 40-337 (1999).

Arkansas

The Arkansas State Highway Commission has exclusive authority over grade crossings, including the power to determine and prescribe the manner; location; terms of installation; operation; maintenance; alteration and abolishment; separation of grades; and protection and apportionment of expenses. Ark. Code Ann. §§ 23- 12-301-1001-1002 (1999).

California

The California Public Utilities Commission has exclusive authority to abolish any crossing of a public or publicly used road or highway by a railroad or street railroad and of a street by railroad. Cal. [Pub. Util.] Code §§ 1202 (a)-(b) 1201 (West 1999).

Colorado

The Colorado Public Utilities Commission has the

power, upon its own motion or upon complaint of an interested party, to order the abolishment of a highway-rail grade crossing. The process requires a hearing before which all interested parties, including the owners of any adjacent property, must be given due notice. Colo. Rev. Stat. § 40-4-106(2)(3) (1999).

Connecticut

The commissioner of transportation is granted statutory authority to relocate or close highway-rail grade crossings.

The process may be initiated upon written petition to the commissioner by the selectmen of any town; the mayor and common council of any city; or the warden and burgesses of any borough within which a highway crosses a railroad. The commissioner appoints a time and place for hearing the petition and gives notice to the petitioners. Conn. Gen. Stat. § 13B-270 (West 1998).

A similar procedure applies to the directors of any railroad company whose track is crossed by a highway. Any railroad company may bring its petition in writing to the commissioner, alleging that public safety necessitates the elimination of a crossing. The commissioner shall appoint a time and place for hearing the petition after reasonable notice to all affected parties. Conn. Gen. Stat. § 13B-273 (West 1998).

The commissioner may also, in the absence of any application, upon his or her own motion, when in his or her opinion public safety requires it, and after notice and proper hearing, order alterations—including removal—of a highway crossed at grade by a railroad or railroads. In the process, he or she shall determine and direct by whom such alterations shall be made, at whose expense and within what time frame; but in any case, no more than one-fourth of the expenses is to be borne by the state, and the remainder is to be assessed upon the railroad. Conn. Gen. Stat. §13B.274 (West 1998).

The commissioner of transportation, on written application of the selectmen of any town; the mayor and common council of any city; or the warden and burgesses of any borough; or on his or her own motion, may make orders and direct the relocation of an existing grade crossing where it can be shown that the crossing at the alternative location is in the interest of public safety, providing the state, town, city, or borough making the request shall bear the cost of the relocation and the maintenance thereafter shall be borne in the same manner as prior to the relocation. Conn. Gen. Stat. § 13-b-272 (West 1998).

If the commissioner of transportation finds that a dangerous condition exists at such crossing, except a dangerous condition arising out of improper or inadequate maintenance, he or she shall issue such an order to such municipality or to any public service company directing the removal, change, or relocation of the crossing, highway, tracks, pipes, wires, poles, or other fixtures or tree or building or other structure; and shall apportion the cost among the public service company or companies, the municipality, and the state and shall determine the conditions and the time and manner of the payment, provided that the portion of the cost to be paid by the public service company shall not exceed 10 percent. Conn. Gen. Stat. 13b-276 (West 1998).

Delaware

The Delaware Department of Transportation has the authority to order the closing of highway-rail crossings. Del. Code Ann. tit. 2 § 1804 (1999).

District of Columbia

The mayor of the District of Columbia has statutory authority to order a grade crossing elimination. D.C. Code Ann. § 7-137 (1999).

Florida

The Florida Department of Transportation (FDOT) has regulatory authority over all public highway-rail grade crossings in the state. A public highway-rail grade crossing is defined in the Florida statute as any location at which a railroad track is crossed at grade by a public road.

FDOT is mandated to work with the various railroad companies to develop and initiate a program for the expenditure of funds for the performance of projects aimed at reducing grade crossing hazards. Fla. Stat. Ann. § 335.141 (West 1999 Supplement).

FDOT, in conjunction with other governmental units and the private sector, is tasked with the responsibility of developing and implementing a statewide rail program designed to ensure the proper maintenance, safety, revitalization, and expansion of the rail system. Among the myriad duties under the statute, FDOT is required to administer rail operating and construction, including the regulation of maximum train operating speeds; the opening and closing of public grade crossings; the construction and rehabilitation of public grade crossings; and the installation of traffic control devices at public grade crossings. The administration

of the program by FDOT includes participation in funding. Fla. Stat. Ann. § 341.302 (West 1999 Supplement).

Georgia

The Georgia Department of Transportation (GDOT) has authority for final approval of grade crossing eliminations. The statute indicates that, when necessary in the interest of public safety, the unit of local government with jurisdiction may authorize and direct the elimination of a grade crossing by construction of an overpass or underpass, provided that no grade crossing shall be eliminated without prior approval from GDOT.

Once a decision is made by either entity, prompt notice must be given to the affected railroads. All parties must meet within 30 days and must further agree on a method of closure and separation within 90 days. If there is no agreement within the specified time, the department, county, or municipality may proceed with construction or may, by written order, direct the interested railroads to proceed with construction. Ga. Code Ann. §§ 32-6-193-194 (1998).

Hawaii

Hawaii has no code section relating to this topic.

Idaho

The Idaho Transportation Department (ITD) has statutory authority to negotiate and enter into an agreement with the railroad companies to provide for grade crossing elimination on state highways.

For crossings not on state highways, the local authorities and railroad companies have the same authority and duties with respect to the elimination or alteration of such crossings as are granted to and required of ITD and the various railroad companies. Idaho Code §§ 62-301-303 (1999).

Illinois

The Illinois Commerce Commission (ICC) has statutory authority to order the elimination of a highway-rail grade crossing. After a hearing, ICC has the power to require major alteration of or to abolish any crossing heretofore or hereafter established when, in its opinion, public safety demands it. This authority does not extend to grade crossings in cities, villages, and incorporated towns of 1 million or more inhabitants.

ICC, after a hearing of all the parties, can prescribe the terms upon which any separation is to be made and the proportion in which the expense of any alteration or abolition of such crossings or the separation of such grades is to be divided between the affected rail carrier(s) or between the carrier(s) and the state, county, municipality, or other public authority in interest.

ICC also has the power to order the reconstruction, minor alteration, minor relocation, or improvement of any crossing (including all necessary highway approaches thereto) of any railroad across any highway or public road, regardless of whether the crossing is at grade or by overhead structure or by subway, whenever ICC finds after a hearing or without a hearing as otherwise provided that any such reconstruction, alteration, relocation, or improvement is necessary to preserve or promote the safety or convenience of the public or of the employees or passengers of such rail carrier or carriers.

The statute also provides that no highway-rail at-grade crossing is to be permanently closed without first convening a public hearing with notice of such hearing being published in an area newspaper of local general circulation.

The following factors are to be considered by ICC in developing the specific criteria for opening and abolishing grade crossings:

1. Timetable speed of passenger trains.
2. Distance to an alternate crossing.
3. Collision history for the last five years.
4. Number of vehicular traffic and posted speed limits.
5. Number of freight trains and their timetable speeds.
6. Type of warning device present at the grade crossing.
7. Alignments of the roadway and railroad, and the angle of intersection of those alignments.
8. Use of the grade crossings by trucks carrying hazardous material, vehicles carrying passengers for hire, and school buses.
9. Use of the grade crossing by emergency vehicles. 625 ILCS 5/18c-7401 (1999).

Indiana

Indiana statute gives the Indiana Department of Transportation (INDOT) the authority to order closed and abolished as a public way within the limits of a railroad right of way any grade crossing then in existence at the time INDOT assumes jurisdiction of the

matter. INDOT's order must be based on a determination that the enhancement of public safety resulting from the closing will outweigh any inconvenience caused by rerouting traffic. The authority of INDOT to legally close and abolish grade crossings is in addition to any authority by law granted to other state agencies or units of local government. Units of local government have the authority to abolish a public railroad crossing but not the authority to open one.

Upon the issuance of any such order by INDOT, the railroad(s) involved is to physically remove the crossing from the tracks. The government unit responsible for maintaining the highway is to remove approaches to the crossing or barricade them. Ind. Code Ann. § 8-6-7.7-3 (Burns 1998 Supplement).

INDOT is required to develop criteria for use in determining whether to open a new public railroad grade, and to develop criteria that INDOT and the unit of local government can use in determining whether to abolish a public railroad grade crossing.

In the application of the criteria, INDOT or the unit of local government will consider the following:

1. Timetable speed of passenger trains operated through the crossing.
2. Distance to an alternate crossing.
3. Collision history of the crossing for the five years preceding INDOT's or the unit's consideration.
4. Amount of vehicular traffic and posted speed limits for the crossing.
5. Amount of freight trains and their timetable speeds operated through the crossing.
6. Type of warning device present at the crossing, if any.
7. Alignment of the roadway and the railroad, and the angle of the intersection of an alignment at the crossing.
8. Use of the crossing by:
 - a. Trucks carrying hazardous materials;
 - b. Vehicles carrying passengers for hire;
 - c. School buses; and
 - d. Emergency vehicles.
9. Other appropriate criteria as determined by INDOT. Ind. Code Ann. §8-6-7.7-3.1(Burns 1998 Supplement).

A person may petition a unit (local government) under whose jurisdiction a public railroad crossing lies for closure of the crossing. The unit is then required to conduct a public hearing. The unit has three options: 1)

If it determines that the crossing in question meets the criteria adopted by INDOT under the previous section for closure of the crossing, the unit may approve the petition and issue an order to close the crossing. The unit's findings must be made available to INDOT; 2) if the unit determines that the crossing meets the criteria, but a compelling reason has been shown to exist for the crossing to remain open, it may then deny the petition to close with a copy of findings to INDOT; and 3) the unit may determine that the crossing in question does not meet the criteria established by INDOT and deny the petition for closure.

Nothing in this chapter, however, is intended to preclude a unit and a railroad from agreeing on their own to close a crossing within the jurisdiction of the unit. Ind. Code Ann. § 8-6-7.7-3.2 (Burns 1998 Supplement).

A decision to deny a petition to close a crossing may be reviewed by INDOT and a determination made whether to schedule an appeal. The decision to schedule or not schedule an appeal is: 1) In the sole discretion of INDOT; 2) final and conclusive; and 3) not subject to review. Upon review of the findings of the unit, INDOT may determine that the crossing meets the criteria for closure, opening, or denial of a closure and that a compelling reason has been shown for the crossing to remain open, in which case INDOT shall issue written findings that the crossing may remain open. If, on the other hand, INDOT determines that the crossing meets the criteria for closure and that a compelling reason has not been shown for the crossing to remain open, INDOT may issue an order abolishing the crossing. Ind. Code Ann. § 8-6-7.7-3.3 (Burns 1998 Supplement).

INDOT also has the authority to approve a petition to open a crossing. If it finds that the proposed crossing meets the criteria required to open a new grade crossing and that a compelling reason has been shown for the crossing to exist, it may issue an order approving the petition. Ind. Code Ann. § 8-6-7.7-4 (Burns 1998 Supplement).

Iowa

Whenever a railway track crosses or is planned to cross a highway, street, or alley, the affected railroad and the Iowa Transportation Department (Iowa DOT), in the case of a primary highway; the board of supervisors of the county in which the crossing at issue is located, in the case of secondary roads; or the city council, in the case of streets and alleys located within a city, may agree upon the location, manner, vacation, physical structure, characteristics, and maintenance of the crossing. Iowa Code § 327G.15 (1998).

If any of the parties cannot agree upon the location, manner, vacation, physical structure, characteristics, and maintenance of the crossing, either party may make written application to Iowa DOT requesting a solution. Iowa DOT is required to request the Department of Inspections and Appeals to set a date for hearing and give 10 days' written notice of the date. Iowa Code § 327G.16 (1998).

Kansas

The statutes of Kansas provide for a shared responsibility for both closures and consolidations, depending on which type of highway the railroad crosses at grade. The secretary of transportation's authority covers state roads; the State Corporation Commission's authority extends to crossings on city, county, or township roads. Likewise, the governing bodies of first- and second-class cities have similar authority to require railroad companies owning or operating any railroad or street-railway to erect, construct, reconstruct, complete, and keep in repair any viaduct or viaducts upon or over or tunnels under such street or streets and over or under any such track or tracks, including the approaches of such viaduct, viaducts, or tunnels as may be deemed and declared by the governing body to be necessary for the convenience, safety, or protection of the public.

Still another section of the statute confers the same authority on the governing bodies of first- and second-class cities in counties of 90,000 population or more.

The secretary of transportation, in the construction, improvement, reconstruction, or maintenance of the state highway system, shall have the power and authority to compel all railroad companies operating steam or electric railroad in the state to construct, improve, reconstruct, or maintain in a manner to be approved by the secretary, viaducts, tunnels, underpasses, bridges, or grade crossings where the lines of said railroad companies intersect state highways, in the judgment of the secretary such viaducts, tunnels, underpasses, bridges, or grade crossings are necessary for the proper construction of the state highway system, for the safety of the general public, or for the elimination of a dangerous grade crossing. The expense of such construction, improvement, reconstruction, or maintenance may be divided between the railroad company and the secretary of transportation in a fair and equitable proportion to be determined by the secretary. However, the secretary shall not pay more than 50 percent of the cost, but such 50-percent limitation shall not apply to express highway for freeways. Otherwise, grade

crossings shall be constructed and maintained at the expense of the railroad company.

If, after due notice to the railroad company that in the judgment of the secretary, the construction, improvement, reconstruction, or maintenance of a viaduct, tunnel, underpass, bridge, or grade crossing is necessary, and the affected railroad company fails to comply with the secretary's order, the secretary is then empowered and authorized to immediately begin to construct, improve, reconstruct, or maintain such viaduct, tunnel, underpass, bridge, or grade crossing and submit a bill for the work to the railroad company. If the railroad refuses to submit payment, the secretary shall forward the information to the attorney general of the state, who may immediately institute a suit in the name of the secretary for recovery.

Under this same section, the secretary, when he or she deems it advisable, may require the railroad company to install and maintain suitable safety devices or warning signals at dangerous or obscure crossings to indicate the approach of trains. Kan. Stat. Ann. § 68-414 (1998).

The governing body of all cities of the first and second class also has the power to regulate the crossings of railway and street-railway tracks and provide precautions and adopt ordinances regulating the same. This includes the power to require all railway companies to erect viaducts over or tunnels under their tracks at the crossing of streets. The governing body shall have power to require any railroad company or companies owning or operating any railroad or street-railway tracks or tracks upon or across any public street or streets of the city to erect, construct, reconstruct, complete, and keep in repair any viaduct or viaducts upon or over or tunnels under such street or streets and over or under any such track or tracks, including the approaches of such viaduct, viaducts, or tunnels as may be deemed and declared by the governing body to be necessary for the convenience, safety, or protection of the public. Kan. Stat. Ann. § 12-1633 (1998).

At the request of the governing body of any city, county, or township, and after proper investigations made in cooperation with the secretary of transportation, the State Corporation Commission may designate those railroad grade crossings on city, county, or township roads which are dangerous. At all crossings so designated, the commission may order the installation of appropriate safety devices to be installed and maintained by the railroad. The State Corporation Commission is empowered to determine the number, type, and location of such safety devices that must

conform with generally recognized standards. The commission has additional authority to close and abolish grade crossings on city, county, or township roads that are in proximity to crossings on which safety devices have been ordered, subject to the approval of the governing body of such city, county, or township, and to require the payment of a portion of the cost of the installation of the safety devices by the affected railroad or railroads, provided that the cost to the railroad shall be not less than 20 percent nor more than 50 percent of the total installation costs. Kan. Stat. Ann. § 66-321a (1998).

The governing body of all cities of the first and second class in a county having a population of over 90,000 has the power to require any railroad company or companies owning or operating any railroad or street-railway track or tracks upon or across any public streets of the city to erect, construct, reconstruct, complete, and keep in repair any viaduct or viaducts upon or over or tunnels under such street or streets and over or under such tracks, including the approaches of such viaducts, viaducts, or tunnels as may be deemed and declared by ordinance to be necessary for the convenience, safety, or protection of the public. Kan. Stat. Ann. §§ 12-1634-68-509 (1998).

Kentucky

The Department of Highways has the authority to order any railroad company owning or operating a railroad in the state to eliminate any grade crossing or change any existing overhead or underpass structure where any public road crosses the railroad tracks of the railroad company when it considers it necessary for public safety. In the process, the Department of Highways may determine whether a substitute crossing should be established and, if so, the location and whether it shall pass over or under the railroad tracks or intersect them at grade.

The department is responsible for the promulgation of administrative regulations containing standards that govern the closure of public grade crossings. The standards reflect the intent of the legislation, that public safety will be enhanced by reducing the number of redundant and inherently dangerous grade crossings.

On or before July 1, 1993, on or before July 1 of each of the next four years, and as necessary thereafter, the department is required to compose a list of grade crossings to be closed. The department must notify the public officials having the necessary authority and the railway companies operating the railroads of the proposed closures. Either affected party may

request a public hearing, and, if it is requested, the department is required to hold the hearing and apply in its determination the information gained at the public hearing. If after the hearing the department determines that closure is warranted, it may order the crossing closed. If a request for a hearing is not received by the department within 30 days of notice of the opportunity, the department shall order the crossing closed. Ky. Rev. Stat. Ann. § 177.120 (1)(2)(3) (1999 Supplement).

Any railroad company dissatisfied with a final order of the department directing the elimination of any grade crossing or change of existing overhead or underpass structure, or any order modifying or amending the final order, may appeal by filing in circuit court. The court has the authority to affirm or to overrule the order of the department. Ky. Rev. Stat. Ann. § 177.190 (1999 Supplement).

There is a different procedure for ordering elimination of a grade crossing or modifications to grade crossings when the crossing is on a county road in counties containing a city of the first class.

The Fiscal Court, when it considers it reasonably necessary for the public safety, may order any railroad company, either steam or electric, owning or operating a railroad in its county to eliminate any existing grade crossing or change any existing overhead or underpass structure where any county road crossed the railroad tracks of such company. Ky. Rev. Stat. Ann. § 178.355(1) (Baldwin 1998).

Note: The Fiscal Court is a county government agency in Kentucky. It is empowered to exercise all the corporate powers of the county unless otherwise provided by law. Ky. Rev. Stat. Ann. §§ 67.080- 67.040 (Baldwin 1998).

The Fiscal Court is required to give at least 10 days' notice by certified mail of a hearing. At any such hearing it shall consider whether or not the proposed grade separation or change is reasonably necessary and the most advantageous method of effecting the grade separation or change. In determining whether the proposed grade separation or change is reasonably necessary, the Fiscal Court shall receive evidence of and consider all relevant facts, including the present and prospective density of highway traffic and the present and prospective frequency and speed of train movements over the crossing; the adequacy of existing or proposed signals or warning devices for the protection of highway traffic at the grade crossing; the possibility and probability of personal injury to the public using the highway and to employee and passengers of the railroad company and damage

to property; and the cost of the grade separation or change in relation to benefits resulting from the proposed construction. Ky. Rev. Stat. Ann § 178.355 (2) (Baldwin 1998).

Louisiana

In 1998, the Louisiana legislature enacted legislation that authorized the Department of Transportation and Development (LADOTD) to require closure of state-maintained railroad grade crossings. The legislation requires a prioritization of proposed crossing closures, along with notification of affected parties prior to closure. It provides for public hearings and alternative actions to closing by a local government authority; spells out the responsibility for funding by the local governing authority; directs promulgation of rules and regulations by the department; and requires certain factors for consideration in development of criteria for crossing closure; and other related matters.

The secretary of LADOTD can require the closure of crossings. The statute provides for LADOTD to complete a study no later than March 1, 1999 to establish priorities for railroad grade crossing closures and to develop a prioritized plan for implementing railroad grade crossing closures.

The department may change the location of or abolish any existing public grade crossing on any state-maintained highway in the state when it determines that it is necessary for the safety of the public. The process must comply with the following procedures:

1. Within not less than 180 days prior to the closure of any public crossing, LADOTD shall notify the municipal governing authority of the area in which the crossing is located; the governing authority of the parish in which the crossings located; the railroad company whose railroad tracks are crossed at grade by the highway; emergency services providers providing services within the affected area; and any other party deemed by the secretary to be interested in the closing procedure. Such notification of closures shall offer opportunity for rebuttals and alternative actions to such closures.
2. Not less than 90 days prior to the possible closure of any public grade crossing, LADOTD shall hold a public hearing in the parish or municipality of the affected grade crossing.
3. After the hearing, LADOTD shall attempt to address any concerns raised at the hearings relative to the proposed closing. However, if the secretary determines that the closure is

consistent with the standards established by LADOTD and in the public interest, LADOTD shall issue an order to close the existing grade crossing. Any such closure order shall also determine the manner in which such closure shall be made including a determination as to any alteration to be made to the crossing and the method of diversion of traffic to an alternate road or crossing. No provisions of this act shall impose any liabilities of any nature upon the state of Louisiana or any agency of the state.

Any local governing authority that opposes the closure of a grade crossing within its territorial jurisdiction may agree to undertake the upgrading of warning devices and additional safety alternatives in compliance with requirements determined by LADOTD as an alternative to the proposed closing. The expense of the alternative upgrade of the crossing must be borne by the local government.

At the written request of any local governing authority, LADOTD shall investigate the need to change the location of or abolish a railroad grade crossing within the jurisdiction of such governing authority and that is not on a state-maintained roadway. After compliance with the provisions of this section, LADOTD may, upon determination of the need for closure of the crossing, proceed with the relocation or abolishment of the crossing. The application by the local governing authority shall constitute the consent of the authority for such closing.

LADOTD, subject to the provisions of the Administrative Procedure Act, shall promulgate rules and regulations to implement the provisions of this section—relocation or abolishment. The rules and regulations shall include specific criteria for the closure of grade crossings. The following factors are to be considered in developing closure criteria:

1. Total number of daily vehicular use at crossing.
2. Total number of trains passing the crossing daily.
3. Alternative routes and distance to such routes.
4. Timetable speeds of trains passing the crossing.
5. Collision history of the crossing.
6. Type of warning device presently at the crossing.
7. Degree of difficulty involved in improvement of roadway approach to the crossing or in providing adequate warning devices.
8. Use of the crossing by vehicles carrying

hazardous materials, vehicles carrying passengers for hire, and school buses.

9. Use of grade crossing by emergency vehicles.
10. Sight distance and reduced visibility at the crossings.
11. Angle of intersection of alignments of the roadway and the railroad.
12. Redundancy of crossings in the area.
13. Proximity to a new crossing or a recently upgraded crossing.
14. Availability and responsibility of user of private crossing.
15. Other factors LADOTD determines necessary in the development of this criteria. La. Rev. Stat. Ann. § 48:390 (West 1999).

Maine

The Maine Department of Transportation (MaineDOT) has the authority to close or discontinue a crossing. The municipal officers, in instances of town ways crossing or crossed by a railroad, whether the crossing is at grade or otherwise, or any railroad corporation may petition MaineDOT alleging that public safety or public convenience either to the traveling public or in the operation of railroad services requires abolishment of or reconstruction of or alteration of crossings or its approaches; or change in the method of crossing a public way; or the closing of a crossing and the substitution of another; or the removal of obstructions to the sight at the crossing and requesting the situation be remedied. After proper notice and hearing, MaineDOT shall make its determination to insure safety or public convenience and by whom the abolishment, reconstruction, alteration, change, or removal shall be made. MaineDOT can issue an order after notice of not less than 10 days to the railroad and municipality or after a hearing if requested within the 10 days either by the railroad or the municipality. Me. Rev. Stat. ANN. tit. 23 § 7207 (West 1999).

Maryland

The Maryland State Highway Administration (SHA) has general authority to abandon, relocate, construct, or reconstruct any railroad grade crossing or railroad grade separation that is dangerous or inconvenient for public travel. If the railroad-grade crossing is dangerous or inconvenient for public travel, SHA may construct a railroad grade separation. Md. Ann. Code art. 8 § 640(b)(2) (Michie 1998).

The Maryland secretary of transportation has general authority to approve the construction or modification of a railroad grade crossing or a change of crossing protection equipment and to impose conditions

necessary to insure public safety at the crossing. No other approval, safety condition, or protective measure may be required by any public authority.

Except for an industrial track spur or siding, a railroad may not construct, reconstruct, improve, widen, relocate, or otherwise alter a railroad grade crossing over a state, county, or municipal highway, except in Baltimore City or over a private road, or change the crossing protection at such a crossing unless approved by the secretary.

This same section provides that a person may not construct, reconstruct, improve, widen, relocate, or otherwise alter either a railroad grade crossing over a public highway or a private road over a railroad or change the crossing protection at such a crossing unless approved by the secretary. Md. Ann. Code art. 8 § 639 (Michie 1998).

Massachusetts

The Department of Telecommunications and Energy (DTE) has the authority to order grade crossing closure.

The Department of Highways plays a supporting role by investigating crossings where a public or private way and a railroad cross each other at grade. The department receives petitions for the abolition of grade crossings from the aldermen of a city; the selectmen of a town; the commissioners of the county where such a crossing exists; or the board of directors of the railroad corporation operating the railroad crossed. After a hearing, due notice of which is given to the railroad corporation, city or town, and county, the department may, in its discretion, place a crossing on a list of crossings, the abolition of which be given early consideration. The department is required to file the list annually on or before October 1 with DTE.

After giving due notice to the Department of Highways, the counties and municipalities in which the identified crossings are located, and the affected railroad corporations, DTE proceeds to hold public hearings on the list. When the hearings are completed, DTE may order a program of grade crossings. The program can be amended or revised from time to time by DTE on requests from the Department of Highways. Mass. Ann. Laws ch. 159, §§ 65-70 (1998).

Michigan

The Michigan Department of Transportation has exclusive authority to order the elimination of highway-

rail crossings. The department, when it determines that it is necessary for public safety, may change the location of or abolish any existing public at-grade crossing after not less than 30 days' notice in the affected areas. If an affected party requests a hearing, the department must hold one, and within 30 days after the date of the hearing, can issue an order to close the existing grade crossing. Mich. Comp. Laws Ann. § 462.307 (1999). Also see Mich. Stat. Ann. § 22.1263(307)(2) (1999).

Minnesota

The authority to order closure, vacation, relocation, consolidation, or separation lies with the commissioner of transportation. The commissioner has the further responsibility for the adoption of rules containing standards governing the vacation and separation of public at-grade crossings. In the adoption of those standards, the commissioner must consider that the number of grade crossings in this state should be reduced, and that public safety will be enhanced by reducing the number of grade crossings. Minn. Stat. § 219.073 (1998).

Public officials with the necessary authority and a railway company may come to an agreement to the vacation, relocation, consolidation, or separation of grades at grade crossings. If they are unable to reach agreement, either party may file a petition with the commissioner who then schedules a hearing. If the commissioner determines that the vacation, relocation, consolidation, or separation is consistent with the standards adopted under Section 210.073, he or she may order the crossing vacated, relocated, consolidated, or separated. Minn. Stat. § 219.074 (1998).

Mississippi

The Mississippi Transportation Commission has statutory authority to regulate and abandon grade crossings on any fixed route as part of the state highway system. Miss. Code Ann. § 65-1-8 (1999).

Whenever any railroad and state highway or part of a state highway shall cross each other at grade, and in the opinion of the commission, such crossing is dangerous to public safety or traffic is unreasonably impeded thereby, and the crossing should be removed, the commission may order the crossing in question eliminated by having the State Highway Department carry the highway either under or over the tracks of the railroad.

The plans covering the proposed changes can be made either by the director of the State Highway Department, subject to the approval of the commission or the affected railroad; but must in either event be approved by both the commission and the railroad company before the contract is awarded. The commission and the railroad are required to pay equal parts of the cost of any underpass or overpass across the right of way of the railroad company. Miss. Code Ann. § 65-1-69 (1999).

Missouri

The Division of Motor Carrier and Railroad Safety of the Department of Economic Development has exclusive power to alter or abolish a crossing, at grade or otherwise, of a railroad by a public road whenever the division finds that public convenience and necessity will not be adversely affected and public safety will be promoted by altering or eliminating the crossing, or to require, where, in its judgment it would be practicable, as separation of grades at any crossing heretofore or hereafter established. The division has the right to refuse its permission or to grant it upon such terms and conditions as it may prescribe.

This authority extends to private crossings in specific instances in which it is determined that the private crossing is being used by the public to the extent that it is necessary to protect and promote public safety. Mo. Rev. Stat. § 389.610 (1998). See also under Missouri in Chapter 11, Private Crossings and Chapter 3, Crossing Treatment Procedures.

Montana

Montana law does not specifically mention closure of highway-rail grade crossings within the code, but general authority over highway-rail crossings is vested in the Montana Public Service Commission. Local authority in unincorporated villages or towns to construct new highway-rail crossings is provided for in the code. Local authority means the board of county commissioners. No railroad crossing, other than a grade crossing, shall be ordered by any board of county commissioners. The Public Service Commission may, however, upon petition or request in writing of any board of county commissioners, order an overhead or underground crossing at any place where a railroad crossing has not been constructed and is required, provided, in its judgment, the safety, necessity, and convenience of the traveling public require such a crossing. Mont. Code Ann. §§ 69-14-606- 69-14-607(2)(a)(b) (1998).

Nebraska

In 1997, the Nebraska legislature passed the Nebraska Highway-Rail Grade Crossing Safety and Consolidation Act. The legislation placed ultimate jurisdiction over all crossings outside of incorporated villages, towns, and cities, both public and private, across, over, or under all railroads in the state with the Nebraska Department of Roads (NDOR). It was the intent of the legislature that any state role regarding highway-rail grade crossings, including public safety, Operation Lifesaver, maintenance, design, consolidation, separation, signalization, improvement, or relocation, be consolidated under one agency. Neb. Rev. Stat. §§ 74-1329-1330-1332 (Michie 1998).

NDOR becomes the final arbitrator whenever a complaint is filed in writing with NDOR by the duly authorized officers of any incorporated village or city, concerning any crossing within such village or city, praying for relief from the matters complained of. NDOR is required to hold a hearing and shall make such order as the facts warrant. The findings of NDOR, subject to the right of appeal, are binding on the parties to the suit. Neb. Rev. Stat. § 1335 (Michie 1998).

The same is true whenever railroad tracks cross a public highway at grade outside of incorporated cities and villages. The owner of the railroad tracks and the county board of the county in which the subject crossing is located may agree upon any change, alteration, or construction of any crossing as will promote the public convenience or safety, and they may agree upon relocation of any highway so as to eliminate such crossings entirely or so as to carry them over or under such railroad and upon the apportionment of the expenses incident to any such change, alteration, relocation, or construction between the owner of the railroad tracks and the county or other public authority in interest. Neb. Rev. Stat. § 74-1337 (Michie 1998).

If the owner of the railroad track and the county board or other public authority in interest fail to agree, either the owner or the county board or other public authority in interest, in the name of the county or other public authority in interest, may file an application with NDOR, setting forth such fact together with a statement of the change, alteration, relocation, or construction it wants, the estimated cost, and such other facts as may be relevant and asking NDOR to enter an order directing the change, alteration, relocation, or construction be made. NDOR shall proceed to hear the application in the manner provided by law, and if it finds that the application should be granted, it shall enter an order accordingly, designating in the order what portion of the expense of complying with the order shall be paid by the

railroad carrier and what portion shall be paid by the county or other public authority in interest, if any. Neb. Rev. Stat. § 74-1338 (Michie 1998).

When the owner of railroad tracks fails, neglects, or refuses promptly to comply with any order of NDOR issued under Sections 74-1332 to 74-1339 or fails or refuses, or neglects to comply with such after NDOR has issued an order, the owner shall be guilty of a Class V misdemeanor and shall be fined in any sum not more than \$100 for each such offense. Each week of such neglect, refusal, or failure shall constitute a separate offense. Neb. Rev. Stat. § 74-1340 (Michie 1998).

Nevada

The Nevada Public Utilities Commission has statutory authority for closure of existing highway-rail crossings.

After an investigation and hearing, which may be initiated either upon the commission's own motion or as the result of the filing of a formal application or complaint by the Department of Transportation, the board of county commissioners of any county, the town board or council of any town or municipality, or any railroad company, the commission may order the elimination, alteration, addition, or change of a highway crossing or crossings over any railroad at grade, or above or below grade, including its approaches and surface. Nev. Rev. Stat. § 704.300(2) (Michie 1998).

New Hampshire

The Department of Transportation has statutory authority to order closure in New Hampshire. Whenever, after hearing upon petition or upon its own motion, the department concludes that public safety requires the closing of any public or private crossing, at grade or above or below the railroad, it may order closure. N.H. Rev. Stat. Ann. § 373:22 (1999).

Railroads in New Hampshire are prohibited from constructing a crossing over another railroad, a highway, or other way, at grade, unless they first obtain the consent in writing of the Department of Transportation. N.H. Rev. Stat. Ann. § 373:4 (1999).

New Jersey

The commissioner and the New Jersey Department of Transportation (NJDOT) have statutory authority to order the construction of new crossings and alterations to existing ones. The statute does not specifically mention authority for closure of existing crossings.

When, in the judgment of the commissioner and NJDOT, crossings are dangerous to public safety or impede public travel, NJDOT may order the railroad(s) to alter such crossings within such time as NJDOT specifies by grade separating the crossing. If in the judgment of NJDOT, the owners of the public or private property will be unduly injured by the elimination of the crossing, NJDOT can order the railroad(s) to relocate the tracks. N.J. Stat. Ann. § 27:1A-62 (West 1998). (Also see Sections 48:2-28 and 48:2-29.)

New Mexico

State statutes do not specifically mention any authority for closure. There is codified, however, a grade-separation procedure.

Whenever a state, county, municipal, or other street or highway, including a highway that is or may be designated as a part of the Federal-Aid Highway System, is constructed or reconstructed so as to cross or intersect a railroad, the State Highway Commission or other governing body may separate the grades at the highway-rail crossing if, in its opinion, it is practicable and reasonably necessary for the protection of the traveling public.

Whenever the public authority is unable to agree with the railroad as to the grade separation and the methodology for carrying it out, the public authority may petition the district court of the county in which the intended separation is located. N.M. Stat. Ann. § 63-3-37 (Michie 1998).

New York

The power to order elimination of a highway-rail crossing lies with the commissioner of transportation.

Any railroad company or governing body of a municipality that contains a highway-rail crossing can petition the commissioner to institute grade crossing elimination procedures.

The commissioner may hold public hearings on any elimination requested by petition after giving due notice to the parties in interest. At the conclusion of the hearing, the commissioner shall, by order, determine whether it is in the public interest to require the elimination of the highway-rail grade crossing. In any elimination order, the procedures for elimination are to be specified. N.Y. [Transp.] Law § 222 (McKinney 1999).

North Carolina

The North Carolina Department of Transportation (NCDOT) has statutory authority to regulate, abandon, and close to use grade crossings on any road designated as part of the state highway system, and whenever a public highway has been designated as part of the state highway system and NCDOT, in order to avoid a grade crossing or crossings with a railroad or railroads, continues or constructs the said road on one side of the railroad or railroads, NCDOT shall have power to abandon and close to use such grade crossings; and whenever an underpass or overhead bridge is substituted for a grade crossing, NCDOT shall have power to close to use and abandon any such grade crossing and any other crossing adjacent to it. N.C. Gen. Stat. § 136-18(11) (1998).

NCDOT also has authority to abolish grade crossings in a road or street not forming a link in part of the state highway system. The statute allows NCDOT to designate who pays in what proportion for the elimination and separation of the crossing. The amounts are based on the same formula provided for grade crossing elimination on the state highway system. N.C. Gen. Stat. § 136.19 (1998).

Further, NCDOT has statutory authority to order crossing closure on roads or streets forming a link in part of the state highway system. If, in the opinion of the secretary, the crossing is dangerous to the traveling public or unreasonably interferes with or impedes traffic on the state highway, NCDOT is required to issue notice requiring the person or company operating the affected railroad to appear before the secretary at an appointed time not less than 10 days or more than 20 days from the date of the notice and show cause, if any, why the railroad should not be required to make adjustment to the crossing or close it. After hearing the matter, the secretary will determine whether a crossing is dangerous to public safety or unreasonably interferes with traffic. If a conclusion is reached that a crossing is dangerous, the secretary can order either closure or separation. N.C. Gen. Stat. § 136-20 (1998).

North Dakota

Declaring that it is in the interest of public safety to eliminate unnecessary railroad grade crossings whenever reasonable access can be safely provided at another crossing, the North Dakota Code places authority with the Public Service Commission to vacate, establish, or relocate crossings, or to separate the grades, if no agreement can be reached by the public officials having the necessary authority and the railroad. Either party to the dispute can file a petition

with the commission, thereby submitting the matter for determination.

The commission, after receiving the petition, is required to give reasonable notice, conduct a hearing, and then issue its order. N.D. Cent. Code § 24-09-10 (Michie 1998).

Ohio

Statutory authority for the alteration or elimination of highway-rail crossings lies with local governments.

Both the legislative authorities of municipal corporations and the boards of county commissioners are vested with the authority to institute proceedings necessary for the abolition of grade crossings.

Both entities are given authority to meet with the affected railroad corporation to devise a plan for altering, abolishing, and changing the approaches to or the location of the railroad, public way, or the grades so as to avoid an at-grade crossing.

The board of county commissioners is granted the same powers as are conferred upon municipal corporations to alter or require to be altered any railroad crossing for that part of a state, county, or township road which lies within the limits of a municipal corporation.

When a grade crossing exists on a county line road, the respective boards of county commissioners are allowed to join in all the proceedings necessary for grade crossing elimination.

When it does become necessary, on the part of a municipal corporation or county, to join with a railroad company, the legislative authority of the municipal corporation by a two-thirds vote of all the members, or the board of county commissioners by a unanimous vote, can declare a necessity and intent to abolish a grade crossing. The resolutions of both entities may contain the manner in which the eliminations are to be made, the method of constructing any new crossings, by whom the construction is to be done, and how the costs are to be apportioned.

Any time a resolution is passed by either entity, it must be published. Notice of its passage must be given to the affected parties and the owners of the property adjacent to the proposed improvement. Ohio Rev. Code Ann. §§ 4957.01-4957.02-4957.09 (Baldwin 1999).

Oklahoma

The Oklahoma Corporation Commission has statutory authority over all public highway-rail crossings. This authority is inclusive of the right to order elimination and, where practicable, a separation of grade. Okla. Stat. tit. 17, § 84 (1998).

Oregon

The Oregon Department of Transportation has statutory authority to eliminate highway-rail grade crossings.

The department, either upon its own motion or upon an application by a railroad, or the public authority in interest, may find, subsequent to a hearing, that elimination is required in the interest of public safety, necessity, convenience, and general welfare. Or. Rev. Stat. § 824.206 (1998).

Pennsylvania

The Pennsylvania Public Utility Commission has exclusive authority to eliminate highway-rail grade crossings. After due notice and proper hearing to all parties in interest, the commission may order any crossing relocated, altered, suspended, protected, or abolished.

Upon a finding of immediate danger to the safety and welfare of the public, the commission may order an immediate alteration, improvement, or suspension. Any order for suspension must include the following for protection of the motoring public:

1. Removal or covering of crossing warning devices.
2.
 - a) Paving over the tracks.
 - b) Removing the tracks and paving over the area formerly occupied by the tracks.
 - c) Barricading the crossing.

Within a township, borough, or city, the Court of Quarter Sessions of the county may close a crossing upon petition of the railroad company and declare as a public highway any over grade or under grade substitution that is to then be maintained by the proper authorities. Pa. CONS. STAT. § 2702 (1999). Also see 32 Pa. Code § 33.31.

Rhode Island

In the exercise of the police power of the state for the safety of its inhabitants, the state legislature vests

in the Public Utilities Commission the authority to eliminate highway-rail grade crossings. The statute further states that the commission shall have this authority even if, by its order, it effectively deprives a municipality of control of its streets. R.I. Gen. Laws §§ 39-8-1.1 -8-3 (1999).

South Carolina

The Public Service Commission of South Carolina has general authority over highway-rail crossings. The statute provides that the Public Service Commission shall regulate and control by special order in each case the manner in which any street, street railway, or other railroad track may cross any railroad track and the manner of constructing culverts under any railroad so as to effect proper drainage of adjacent territory. S.C. Code Ann. § 58-17-1450 (1998).

South Dakota

The South Dakota Department of Transportation (SDDOT) has the statutory authority for determining the necessity of eliminating grade crossings.

SDDOT can order that any existing or planned crossing be relocated, altered, or abolished upon its own motion or upon complaint, and after a hearing and notice to all interested parties, including the owners of adjacent property and the affected railroad company. S.D. Codified Laws Ann. §§ 31-27-1,27-2 (1999).

Where a new right of way is necessary for the building of a subway or overhead crossing on a state or county highway, the governing body having jurisdiction over the highway may determine when it is necessary to eliminate the dangerous crossing. S.D. Codified Laws Ann. §§ 31-27-12-17 (1999).

Tennessee

The Department of Transportation, through the discretion of the commissioner or the commissioner's designee, has the authority to eliminate grade crossings whenever the crossing elimination is necessary for the protection of persons traveling on the highway or railroad.

The affected railroad company has the right to appeal to the Public Service Commission but only with regard to the period of time required to comply. The Public Service Commission has the authority to stay the order of the commissioner for the actual construction for any length of time not exceeding two years. Tenn. Code Ann. §§ 65-11-107-108-109 (1999).

Texas

The Railroad Commission of Texas has statutory authority for closure of existing grade crossings. Tex. Rev. Civ. Stat. Ann. art. 6502 (West 1999).

There also exists within the Texas Revised Civil Statutes a provision for grade-crossing elimination within every incorporated city or town (including home rule cities) having a population of more than 100,000 inhabitants. Tex. Rev. Civ. Stat. Ann. art. 1105c (West 1999).

Utah

The Utah Department of Transportation has exclusive authority to order the closure of highway-rail grade crossings. Utah Code Ann. § 54-4-15 (1999).

Vermont

The Vermont Transportation Board has statutory authority to determine what alterations, changes, or removals, if any, shall be made and by whom. Vt. Stat. Ann. title 5 §§ 3783-84-85-88 (1999).

Virginia

The Commonwealth Transportation Board has statutory authority to order the elimination of a grade crossing or the consolidation of multiple grade crossings. Va. Code Ann. § 56-365.1 (Michie 1999).

Washington

The Washington State Utilities and Transportation Commission has authority to order closure of existing crossings. Wash. Rev. Code §§ 81.53.030-060 (1999).

West Virginia

The road commissioner may require any railroad company owning, controlling, or operating a railroad in the state to eliminate at-grade highway-rail crossings on existing highways, relocated highways, and extensions of existing highways by separating the grades or by relocating an existing highway. The commissioner may determine the location, design, and grade for any project or structure for the elimination or avoidance of at-grade highway-rail crossings and may determine whether a new, relocated, or extended highway shall pass over or under the railroad right of way or tracks. W.Va. Code § 17-4-10 (1998).

Wisconsin

The Office of the Commissioner of Railroads within the Wisconsin Department of Highways has the authority to abolish highway-rail crossings. Wis. Stat. § 195.29(1)(4)(5) (1999).

Wyoming

The Transportation Commission of Wyoming has the authority to close or establish at-grade crossings on public highways as specified and those over the track(s) of any railroad corporation or street railway corporation in the state.

Upon application to the commission from the authorized agents of the city, counties, or other government entities or the affected railroads, or upon its own motion when public interest indicates action should be taken, the commission must consider the need for closure based on evidence presented, availed, or adduced. The commission must establish a priority rating from the applications or evidence, assigning priority first to the most hazardous railroad crossing location, giving proper weight to increased rail traffic and to the volume of traffic over the crossing with due consideration being given for school buses and dangerous commodities. If the commission determines a need for grade crossing warning devices, it will determine the type of crossing warning devices required, including whether the crossing is to be made at grade or with a grade-separation structure. Wyo. Stat. § 37-10-102 (a)-(b) (1999).

Preemption Calculation Procedures, Example From State Of Texas

APPENDIX





INSTRUCTIONS

for the
Texas Department of Transportation
GUIDE FOR DETERMINING TIME REQUIREMENTS FOR
TRAFFIC SIGNAL PREEMPTION AT HIGHWAY-RAIL GRADE CROSSINGS

USING THESE INSTRUCTIONS

The purpose of these instructions is to assist TxDOT personnel in completing the 2003 Guide For Determining Time Requirements For Traffic Signal Preemption At Highway-Rail Grade Crossings, also known as the Preemption Worksheet. The main purpose of the Preemption Worksheet is to determine if additional time (advance preemption) is required for the traffic signal to move stationary vehicles out of the crossing before the arrival of the train.

If you have any questions about completing the Preemption Worksheet, please contact the Mr. David Valdez in the Traffic Operations Division at telephone 512-416-2642 or email DVALDEZ@dot.state.tx.us. For any feedback on the Draft version of the Worksheet or Instructions, please contact Mr. Roelof Engelbrecht from the Texas Transportation Institute at 979-862-3559 or roelof@tamu.edu.

SITE DESCRIPTIVE INFORMATION:

Enter the location for the highway-rail grade crossing including the (nearest) **City**, the **County** in which the crossing is located, and the Texas Department of Transportation (TxDOT) **District** name. When entering the District name, do not use the dated district numbering schema; use the actual district name.

Next, enter the **Date** the analysis was performed, your (the analyst's) name next to "**Completed by**," and the status of the **District Approval** for this crossing.

To complete the reference schematic for this site, place a **North Arrow** in the provided circle to correctly orient the crossing and roadway. Record the name of the **Parallel Street** and the **Crossing Street** in the spaces provided, and remember to include any "street sign"/local name for the streets as well as any state/US/Interstate designation (i.e., "FM 1826," "SH 71," "US 290," "Interstate 35 [frontage]"). You may wish to note other details on the intersection/crossing diagram as well, including the number of lanes and/or turn bays on the intersection approach crossing the tracks and any adjacent land use.

Enter the **Railroad** name, **Railroad Contact** person's name, and **Phone** number for the responsible railroad company and its equipment maintenance and operations contractor (if any). Finally, record the unique 7-character **Crossing DOT#** (6 numeric plus one alphanumeric characters) for the crossing.

Note that this guide for determining (warning) time requirements for traffic signal preemption requires you to input many controller unit timing/phasing values. To preserve the accuracy of these values, record all values to the next highest tenth of a second (i.e., record 5.42 seconds as 5.5 seconds).

SECTION 1: RIGHT-OF-WAY TRANSFER TIME CALCULATION

Preempt Verification and Response Time

Line 1. The **preempt delay time** is the amount of time, in seconds, that the traffic signal controller is programmed to wait from the initial receipt of a preempt call until the call is "verified" and considered a viable request for transfer into preemption mode. Preempt delay time is a value entered into the controller unit for purposes of preempt call validation, and may not be available on all manufacturer's controllers.

Line 2. Unlike preempt delay time (Line 1), which is a value entered into the controller, **controller response time to preempt** is the time that elapses while the controller unit electronically registers the preempt call (i.e., it is the controller's equipment response time for the preempt call). The controller manufacturer should be consulted to find the correct value (in seconds) for use here. For future reference, you may wish to record the controller type in the **Remarks** section to the right of the controller response time to preempt value. However, note that the manufacturer's given response time may be unique for a controller unit's model and software generation; other models and/or software generations may have different response times.

Line 3. The sum of Line 1 and Line 2 is the **preempt verification and response time**, in seconds. It represents the number of seconds between the receipt at the controller unit of a preempt call issued by the railroad's grade crossing warning equipment and the time the controller software actually begins to respond to the preempt call (i.e., by transitioning into preemption mode).

Worst-Case Conflicting Vehicle Time

Line 4. Worst-case conflicting vehicle phase number is the number of the controller unit phase which conflicts with the phase(s) used to clear the tracks—the track clearance phase(s)—that has the longest sum of minimum green (if provided), other (additional) green time (if provided), yellow change interval, and red clearance interval durations that may need to be serviced during the transition into preemption. Note that all of these time elements are for vehicular phases only; pedestrian phase times will be assessed in the next part of the analysis. The worst-case vehicle phase can be any phase that conflicts with the track clearance phase(s); it is not restricted to only the phases serving traffic parallel to the tracks.

Line 5. Minimum green time during right-of-way transfer is the number of seconds that the worst-case vehicle phase (see Line 4 discussion) must display a green indication before the controller unit will terminate the phase through its yellow change and red clearance intervals and transition to the track clearance green interval. The minimum green time during right-of-way transfer may be set to zero to allow as rapid a transition as possible to the track clearance green interval. However, local policies will govern the amount of minimum green time provided during the transition into preemption.

Line 6. If any additional green time is preserved beyond the preempt minimum green time for the worst-case vehicle phase (line 4), it should be entered here as **Other green time during right-of-way transfer**. Given the time-critical nature of the transition to the track clearance green interval during preempted operation, this value is usually zero except in unusual circumstances. One situation where other green time may be present is when a trailing green overlap is used on the worst-case vehicle phase, and the controller unit is set up to time out the trailing green overlap on entry into preemption.

Line 7. Yellow change time is the required yellow change interval time for the worst-case vehicle phase (line 4) given prevailing operating conditions. Yellow change time for the phase under preemption is usually the same value, in seconds, programmed for the phase under normal operating circumstances. Section 4D.13 of the *Texas Manual on Uniform Traffic Control Devices (MUTCD)* states that the normal yellow change interval shall not be shortened or omitted during the transition into preemption control. Guidance on setting the yellow change interval can be found in the Institute of Transportation Engineer's *Determining Vehicle Signal Change and Clearance Intervals*.

Line 8. Red clearance time is the required red clearance interval for the worst-case vehicle phase (line 4) given prevailing operating conditions. Red clearance time for the phase under preemption is usually the same value, in seconds, programmed for the phase under normal operating circumstances. Section 4D.13 of the *Texas MUTCD* states that the normal red clearance interval shall not be shortened or omitted during the transition into preemption control. Guidance on setting the red clearance interval can be found in the Institute of Transportation Engineer's *Determining Vehicle Signal Change and Clearance Intervals*.

Line 9. Worst-case conflicting vehicle time is the sum of lines 5 through 8. It will be compared with the worst-case conflicting pedestrian time to determine whether vehicle or pedestrian phase times are the most critical in their impact on warning time requirements during the transition to the track clearance green interval.

Worst-case Conflicting Pedestrian Time

Line 10. Worst-case pedestrian phase number is the pedestrian phase number (referenced as the vehicle phase number that the pedestrian phase is associated with) that has the longest sum of walk time, pedestrian clearance (i.e., flashing don't walk) times, and associated vehicle clearance times that have to be provided during the transition into preemption. The worst-case pedestrian phase is not restricted to pedestrian phases running concurrently with vehicle phases that serve traffic parallel to the tracks. The vehicle phase associated with the worst-case pedestrian phase may even be one of the track clearance phases if the pedestrian phase is not serviced concurrently with the associated track clearance phase.

Line 11. Minimum walk time during right-of-way transfer (seconds) is the minimum pedestrian walk time for the worst-case pedestrian phase (line 10). The *Texas MUTCD* permits the shortening (i.e. truncation) or complete omission of the pedestrian walk interval. A zero value allows for the most rapid transition to the track clearance green interval. However, the minimum pedestrian walk time is typically set based on local policies, which may or may not allow truncation and/or omission.

Line 12. Pedestrian clearance time during right-of-way transfer (seconds) is the clearance (i.e., flashing don't walk) time for the worst-case pedestrian phase. The *Texas MUTCD* permits the shortening (i.e. truncation) or complete omission of the pedestrian clearance interval. A zero value allows for the most rapid transition to the track clearance green interval. However, the pedestrian clearance time is typically set based on local policies, which may or may not allow truncation and/or omission.

Line 13. Enter a **Yellow change time** if the pedestrian clearance interval does not time simultaneously with the yellow change interval of the vehicular phase associated with your worst-case pedestrian phase; enter zero if does. Local policies will determine if this is allowed. Simultaneous timing of the pedestrian clearance interval and the yellow change interval (i.e. a zero value on line 13) allows for the most rapid transition to the track clearance green interval. If a non-zero value is entered, make sure to enter the yellow change time of the vehicular phase associated with your worst-case pedestrian phase. This value may not be the same value you enter on Line 7, since the worst-case pedestrian phase may not be the same as the worst-case vehicular phase.

Line 14. Enter a **Red clearance time** if the pedestrian clearance interval does not time simultaneously with the red clearance interval of the vehicular phase associated with your worst-case pedestrian phase; enter zero if does. Local policies will determine if this is allowed. Also, note that not all traffic signal controllers allow simultaneous timing of the pedestrian clearance interval and the red clearance interval. Simultaneous timing of the pedestrian clearance interval and the red clearance interval (i.e. a zero value on line 14) allows for the most rapid transition to the track clearance green interval. If a non-zero value is entered, make sure to enter the red clearance time of the vehicular phase associated with your worst-case pedestrian phase. This value may not be the same value you enter on Line 8, since the worst-case pedestrian phase may not be the same as the worst-case vehicular phase.

Line 15. Add lines 11 through 14 to calculate your **Worst-case conflicting pedestrian time**. This value will be compared to the worst-case conflicting vehicle time to determine whether vehicle or pedestrian phase times are the most critical in their impact on warning time requirements during the transition to the track clearance green interval.

Worst-case Conflicting Vehicle or Pedestrian Time

Line 16. Record the **Worst-case conflicting vehicle or pedestrian time** (in seconds) by comparing lines 9 and 15 and writing the larger of the two as the entry for line 16.

Line 17. Calculate the **Right-of-way transfer time** by adding lines 3 and 16. The right-of-way transfer time is the maximum amount of time needed for the worst case condition, prior to display of the track clearance green interval.

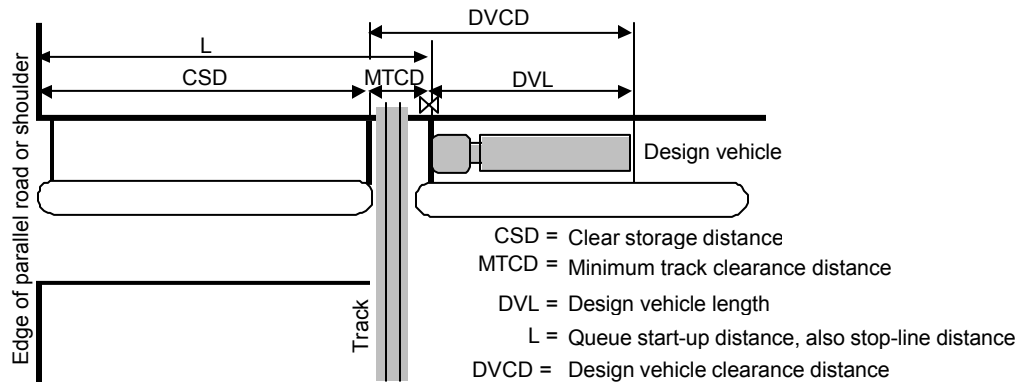

Figure 1 Queue clearance distances.

SECTION 2: QUEUE CLEARANCE TIME CALCULATION

Line 18. Record the **Clear storage distance** (CSD in Figure 1), in feet, as the shortest distance along the crossing street between the edge of the grade crossing nearest the signalized intersection—identified by a line parallel to the rail 6 feet (2 m) from the rail nearest to the intersection—and the edge of the street or shoulder of street that parallels the tracks. If the normal stopping point on the crossing street is significant different from the edge or shoulder of parallel street, measure the distance to the normal stopping point. For angled (i.e., non-perpendicular) railroad crossings, always measure the distance along the inside (centerline) edge of the leftmost lane or the distance along the outside (shoulder) edge of the rightmost lane, as appropriate, to determine the shortest clear storage distance and record that value.

Line 19. Minimum track clearance distance (MTCD in Figure 1), in feet, is the length along the highway at one or more railroad tracks, measured from the railroad crossing stop line, warning device, or 12 feet (4 m) perpendicular to the track centerline—whichever is further away from the tracks, to 6 feet (2 m) beyond the tracks measured perpendicular to the far rail. For angled (i.e., non-perpendicular) railroad crossings, always measure the distance along the inside (centerline) edge of the leftmost lane or the distance along the outside (shoulder) edge of the rightmost lane, as appropriate, to determine the longest minimum track clearance distance and record that value.

Line 20. Design vehicle length (DVL in Figure 1), in feet, is the length of the design vehicle, the longest vehicle permitted by road authority statute on the subject roadway. In the **Remarks** section to the right of the data entry box for Line 20, note the design vehicle type for ease of reference. Some design vehicles from the *AASHTO Green Book (A Policy on Geometric Design of Highways and Streets)* are given in Table 1. Note that Texas legal size and weight limits for non-permit vehicles allow a maximum semitrailer length of 59 feet, resulting in a design vehicle length of 79.5 feet when combined with a conventional long-haul tractor.

Table 1. AASHTO Design vehicle lengths and heights.

Design Vehicle Type	Symbol	Length (ft)
Passenger Car	P	19
Single Unit Truck	SU	30
Large School Bus	S-BUS 40	40
Intermediate Semi-Trailer	WB-50	55

Line 21. Queue start-up distance (L in Figure 1), in feet, is the maximum length over which a queue of vehicles stopped for a red signal indication at an intersection downstream of the crossing must get in motion so that the design vehicle can move out of the railroad crossing prior to the train's arrival. Queue start-up distance is the sum of the clear storage distance (Line 18) and minimum track clearance distance (Line 19).

Line 22. Time required for the design vehicle to start moving (seconds) is the time elapsed between the start of the track clearance green interval and the time the design vehicle, which is located at the edge of the railroad crossing on the opposite side from the signalized intersection, begins to move. This elapsed time is based on a "shock wave" speed of 20 feet per second and a 2 second start-up time (the additional time for the first driver to recognize the signal is green and move his/her foot from the brake to the accelerator). The time required for the design vehicle to start moving is calculated, in seconds, as 2 plus the queue start-up distance, L (Line 21) divided by the wave speed of 20 feet per second. The time required for the design vehicle to start moving is a conservative value taking into account the worst-case vehicle mix in the queue in front of the design vehicle as well as a limited level of driver inattentiveness. This value may be overridden by local observation, but care must be taken to identify the worst-case (longest) time required for the design vehicle to start moving.

Line 23. Design vehicle clearance distance (DVCD in Figure 1) is the length, in feet, which the design vehicle must travel in order to enter and completely pass through the railroad crossing's minimum track clearance distance (MTCD). It is the sum of the minimum track clearance distance (Line 19) and the design vehicle's length (Line 20).

Line 24. The Time for design vehicle to accelerate through the design vehicle clearance distance (DVCD) is the amount of time required for the design vehicle to accelerate from a stop and travel the complete design vehicle clearance distance. This time value, in seconds, can be found through local observation or by using Figure 2. If local observation is used, take care to identify the worst-case (longest) time required for the design vehicle to accelerate through the DVCD. If Figure 2 is used to estimate the time for the design vehicle to accelerate through the DVCD, locate the DVCD from Line 23 on the horizontal axis of Figure 2 and then draw a line straight up until that line intersects the acceleration time performance curve for your design vehicle. Then, draw a horizontal line from this point to the left until it intersects the vertical axis, and record the appropriate acceleration time. Round up to the next higher tenth of a second. For example, with a DVCD of 80 feet and a WB-50 semi-trailer design vehicle on a level surface, the time required for the design vehicle to accelerate through the DVCD will be 12.2 seconds.

If your design vehicle is a WB-50 semi-trailer, large school bus (S-BUS 40), or single unit (SU) vehicle, you may need to apply a correction factor to estimate the effect of grade on the acceleration of the vehicle. Determine the average grade over a distance equal to the design vehicle clearance distance (DVCD), centered around the minimum track clearance distance (MTCD). If the grade is 1% uphill (+1%) or greater, multiply the acceleration time obtained from Figure 2 with the factor obtained from Table 2 and round up to the next higher tenth of a second to get an estimate of the acceleration time on the grade. For example, with a DVCD of 80 feet and a WB-50 semi-trailer design vehicle on a 4% uphill, the (interpolated) factor from Table 2 is 1.30. Therefore, the estimated time required for the design vehicle to accelerate through the DVCD will be $12.2 \times 1.30 = 15.86$ seconds, or 15.9 seconds rounded up to the next higher tenth of a second.

If you selected a design vehicle different from those listed in Figure 2 and Table 2, you may still be able to use Figure 2 and Table 2 if you can match your design vehicle to the weight, weight-to-power ratio, and power application characteristics of the design vehicles in Figure 2 and Table 2. The WB-50 curve and grade factors are based on an 80,000 lb vehicle with a weight-to-power ratio of 400 lb/hp accelerating at 85% of its maximum power on level grades and at 100% of its maximum power on uphill grades, and may therefore be representative of any heavy tractor-trailer combination with the same characteristics. The school bus curve and grade factors are based on a 27,000 lb vehicle with a weight-to-power ratio of 180 lb/hp accelerating at 70% of its maximum power on level grades and at 85% of its maximum power on uphill grades. The SU curve and grade factors are based on a 34,000 lb vehicle with a weight-to-power ratio of 200 lb/hp accelerating at 75% of its maximum power on level grades and at 90% of its maximum power on uphill grades.

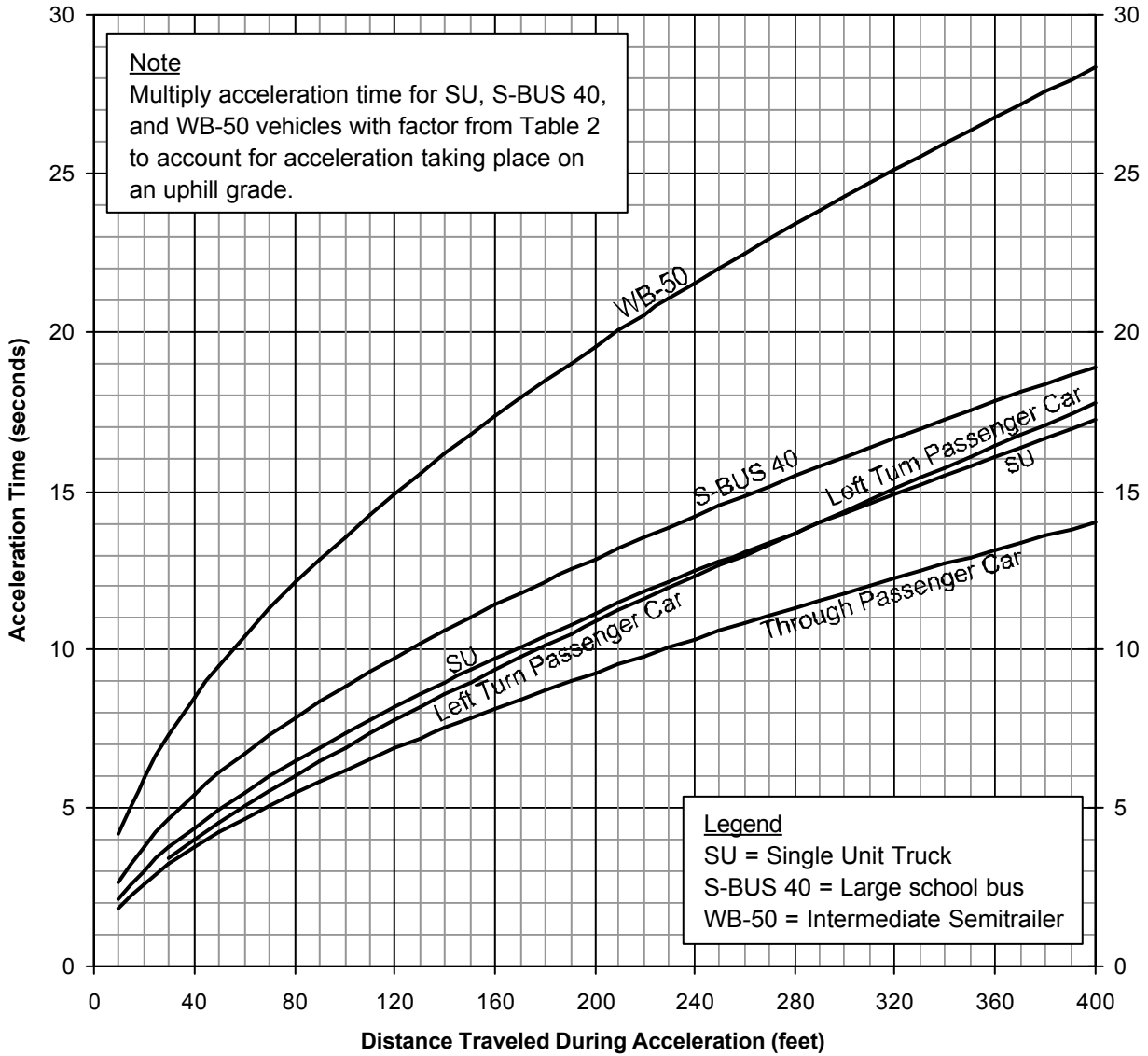

Figure 2 Acceleration time over a fixed distance on a level surface.

Table 2. Factors to account for slower acceleration on uphill grades. Multiply the appropriate factor (depending on the design vehicle, grade, and acceleration distance) with the acceleration time in Figure 2 to obtain the estimated acceleration time on the grade.

Acceleration Distance (ft)	Design Vehicle and Percentage Uphill Grade														
	Single Unit Truck (SU)				Large School Bus (S-BUS 40)					Intermediate Tractor-Trailer (WB-50)					
	0-2%	4%	6%	8%	0-1%	2%	4%	6%	8%	0%	2%	4%	6%	8%	
25	1.00	1.06	1.13	1.19	1.00	1.01	1.10	1.19	1.28	1.00	1.09	1.27	1.42	1.55	
50	1.00	1.09	1.17	1.25	1.00	1.01	1.12	1.21	1.30	1.00	1.10	1.28	1.44	1.58	
75	1.00	1.10	1.19	1.29	1.00	1.02	1.13	1.23	1.33	1.00	1.11	1.30	1.47	1.61	
100	1.00	1.11	1.21	1.32	1.00	1.02	1.14	1.25	1.35	1.00	1.11	1.31	1.48	1.64	
125	1.00	1.12	1.23	1.34	1.00	1.03	1.15	1.26	1.37	1.00	1.12	1.32	1.50	1.66	
150	1.00	1.12	1.24	1.37	1.00	1.03	1.16	1.28	1.40	1.00	1.12	1.33	1.52	1.68	
175	1.00	1.13	1.25	1.38	1.00	1.03	1.17	1.29	1.42	1.00	1.12	1.34	1.53	1.70	
200	1.00	1.13	1.26	1.40	1.00	1.04	1.17	1.30	1.43	1.00	1.13	1.35	1.54	1.72	
225	1.00	1.14	1.27	1.42	1.00	1.04	1.18	1.32	1.45	1.00	1.13	1.35	1.56	1.74	
250	1.00	1.14	1.28	1.43	1.00	1.04	1.19	1.33	1.47	1.00	1.13	1.36	1.57	1.76	
275	1.00	1.14	1.29	1.44	1.00	1.05	1.20	1.34	1.49	1.00	1.14	1.37	1.58	1.77	
300	1.00	1.14	1.30	1.46	1.00	1.05	1.20	1.35	1.50	1.00	1.14	1.37	1.59	1.79	
325	1.00	1.15	1.30	1.47	1.00	1.05	1.21	1.36	1.52	1.00	1.14	1.38	1.60	1.81	
350	1.00	1.15	1.31	1.48	1.00	1.05	1.22	1.37	1.54	1.00	1.15	1.39	1.61	1.82	
375	1.00	1.15	1.31	1.49	1.00	1.06	1.22	1.38	1.55	1.00	1.15	1.39	1.62	1.84	
400	1.00	1.15	1.32	1.50	1.00	1.06	1.23	1.40	1.57	1.00	1.15	1.40	1.63	1.85	

For design vehicle clearance distances greater than 400 feet, use Equation 1 to estimate the time for the design vehicle to accelerate through the design vehicle clearance distance or any other distance:

$$T = e^{\left[a - b \sqrt{c + \frac{2}{b} \ln \left(\frac{d}{X} \right)} \right]} \quad (1)$$

where

- T = time to accelerate through distance X , in seconds;
- X = distance over which acceleration takes place, in feet;
- \ln = natural logarithm function;
- e = 2.17828, the base of natural logarithms; and
- a , b , c , and d = calibration parameters from Table 3.

Note: To interpolate between grades, do not interpolate the parameters in Table 3. The correct way to interpolate is to calculate the acceleration time T using Equation 1 for the two nearest grades and then interpolate between the two acceleration times.

Line 25. Queue clearance time is the total amount of time required (after the signal has turned green for the approach crossing the tracks) to begin moving a queue of vehicles through the queue start-up distance (L , Line 21) and then move the design vehicle from a stopped position at the far side of the crossing completely through the minimum track clearance distance (MTCD, Line 19). This value is the sum of the time required for design vehicle to start moving (Line 22) and the time for design vehicle to accelerate through the design vehicle clearance distance (Line 24).

Table 3. Parameters to estimate vehicle acceleration times over distances greater than 400 feet using Equation 1.

Design Vehicle	Grade	<i>a</i>	<i>b</i>	<i>c</i>	<i>d</i>
Through Passenger Car	Level	7.75	3.252	5.679	2.153
Left Turning Passenger Car	Level	10.29	5.832	3.114	5.090
Single Unit Truck (SU)	Level to 2%	8.16	3.624	5.070	2.018
	4%	10.39	4.865	4.560	1.739
	6%	9.52	4.542	4.393	1.700
	8%	9.38	4.597	4.165	1.668
Large School Bus (S-BUS 40)	Level to 1%	10.02	4.108	5.95	0.885
	2%	11.51	5.254	4.801	1.300
	4%	10.79	5.042	4.577	1.266
	6%	10.61	5.101	4.329	1.253
Intermediate Semi-Trailer (WB-50)	8%	11.84	6.198	3.652	1.554
	Level	17.75	7.984	4.940	0.481
	2%	10.26	4.026	6.500	0.249
	4%	9.39	3.635	6.670	0.193
	6%	9.38	3.732	6.310	0.188
	8%	10.31	4.515	5.219	0.265

SECTION 3: MAXIMUM PREEMPTION TIME CALCULATION

Line 26. Right-of-way transfer time, in seconds, recorded on Line 17. The right-of-way transfer time is the maximum amount of time needed for the worst case condition, prior to display of the track clearance green interval.

Line 27. Queue clearance time, in seconds, recorded on Line 25. Queue clearance time starts simultaneously with the track clearance green interval (i.e. after right-of-way transfer), and is the time required for the design vehicle stopped just inside the minimum track clearance distance to start up and move completely out of the minimum track clearance distance.

Line 28. Desired minimum separation time is a time “buffer” between the departure of the last vehicle (the design vehicle) from the railroad crossing (as defined by the minimum track clearance distance) and the arrival of the train. Separation time is added for safety reasons and to avoid driver discomfort. If no separation time is provided, a vehicle could potentially leave the crossing at exactly the same time the train arrives, which would certainly lead to severe driver discomfort and potential unsafe behavior. The recommended value of four (4) seconds is based on the minimum recommended value found in the Institute of Transportation Engineer’s *ITE Journal* (in an article by Marshall and Berg in February 1997).

Line 29. Maximum preemption time is the total amount of time required after the preempt is initiated by the railroad warning equipment to complete right-of-way transfer to the track clearance green interval, initiate the track clearance phase(s), move the design vehicle out of the crossing’s minimum track clearance distance, and provide a separation time “buffer” before the train arrives at the crossing. It is the sum of the right-of-way transfer time (Line 26), the queue clearance time (Line 27), and the desired minimum separation time (Line 28).

SECTION 4: SUFFICIENT WARNING TIME CHECK

Line 30. Minimum time (seconds) is the least amount of time active warning devices shall operate prior to the arrival of a train at a highway-rail grade crossing. Section 8D.06 of the *Texas MUTCD* requires that flashing-light signals shall operate for at least 20 seconds before the arrival of any train, except on tracks where all trains operate at less than 32 km/h (20 mph) and where flagging is performed by an employee on the ground.

Line 31. Clearance time (seconds), typically known as CT, is the additional time that may be provided by the railroad to account for longer crossing time at wide (i.e., multi-track crossings) or skewed-angle crossings. You must obtain the clearance time from the railroad responsible for the railroad crossing. In cases where the minimum track clearance distance (Line 19) exceeds 35 feet, the railroads' *AREMA Manual* requires clearance time of one second be provided for each additional 10 feet, or portions thereof, over 35 feet. Additional clearance time may also be provided to account for site-specific needs. Examples of extra clearance time include cases where additional time is provided for simultaneous preemption (where the preemption notification is sent to the signal controller unit simultaneously with the activation of the railroad crossing's active warning devices), instead of providing advance preemption time.

Line 32. Minimum warning time (seconds) is the sum of the minimum time (Line 30) and the clearance time (Line 31). This value is the actual minimum time that active warning devices can be expected to operate at the crossing prior to the arrival of the train under normal, through-train conditions. The term "through-train" refers to the case where trains do not stop or start moving while near or at the crossing. Note that the minimum warning time, does not include buffer time (BT). Buffer time is added by the railroad to ensure that the minimum warning time is always provided despite inherent variations in warning times; however, it is not consistently provided and cannot be relied upon by the traffic engineer for signal preemption and/or warning time calculations.

Line 33. Advance preemption time (seconds), if provided, is the period of time that the notification of an approaching train is forwarded to the highway traffic signal controller unit or assembly prior to activating the railroad active warning devices. Only enter advance preemption time if you can verify from the railroad that advance preemption time is already being provided for your site. If you are determining whether or not you need advance preemption time, enter zero for the advance preemption time in Line 33.

Line 34. Warning time provided by the railroad is the sum of the minimum warning time (Line 32) and the advance preemption time (Line 33), in seconds. This value should be verified with the railroad, and should not include buffer time (BT).

Line 35. Additional warning time required from railroad is the additional time needed (if any), in seconds, that is required to provide safe preemption in the worst case (the maximum preemption time on Line 29), given the warning time provided by the railroad (Line 34). The additional warning time required is calculated by subtracting the warning time provided by the railroad (Line 34) from the maximum preemption time (Line 29). If the result of the subtraction is equal to or less than zero, it means that sufficient warning time is available, and you should enter zero (0) on Line 35. However, keep in mind that highly negative (-10 or less) subtraction results may indicate the potential for operational problems due to insufficient track clearance green time. Section 5 of the worksheet contains a methodology for calculating sufficient track clearance green time.

If the additional warning time is greater than zero (0), it means that the warning time provided by the railroad is insufficient, and additional warning time has to be requested from the railroad to ensure safe operation. The railroad can provide additional warning time either by providing additional clearance time (CT) (Line 30), or by providing or increasing advance preemption time (Line 33).

As an alternative, it may be possible to reduce the maximum preemption time (Line 29). To reduce the maximum preemption time, you can reduce either the preempt delay time (Line 1), if this is possible; reduce preempt minimum green time (Line 5) or other green time (Line 6), as long as you do not violate local policies for signal timing; or, reduce yellow change time (Line 7) or red clearance time (Line 8) as long as adequate and appropriate yellow change and red clearance intervals are provided as per the *Texas MUTCD* Section 4D.10 and applicable guidelines such as the Institute of Transportation Engineers' *Determining Vehicle Signal Change and Clearance Intervals*.

If pedestrian rather than vehicular phasing controls warning time requirements for preemption, it may be possible to reduce the minimum walk time (Line 11) and/or pedestrian clearance time (Line 12) as long as you do not violate local policies for signal timing. You can also let the pedestrian clearance time (flashing don't walk) time simultaneous with vehicular yellow change and red clearance and so reduce the values on Line 13 (yellow change time) and Line 14 (red clearance time) to zero (0). If local policies do

not currently allow simultaneous clearance for pedestrian and vehicular phasing, you may want to consider allowing this type of operation to reduce your worst-case conflicting pedestrian time.

Once you have made all of the possible adjustments to the warning time, recompute the totals in Lines 3, 9, 15, 16, 17, 26, 29, and 35. If Line 35 remains greater than zero, then you will have to request additional warning time from the railroad, as described above, to ensure safe preemption of the adjacent signalized intersection.

SECTION 5: TRACK CLEARANCE GREEN TIME CALCULATION (OPTIONAL)

Note: This section is optional and is used to calculate the duration of the track clearance green interval. If this worksheet is only used to determine if additional warning time has to be requested from the railroad, this section need not be completed.

The objective of the section is to calculate the duration of the track clearance green interval to ensure safe and efficient operations at the crossing and adjacent traffic signal.

The Preempt Trap Check section (lines 36 to 44) focuses on safety by calculating the minimum duration of the track clearance green interval to ensure that the track clearance green does not terminate before the gates block access to the crossing. If the gates do not block access to the crossing before the expiration of the track clearance green, it is possible that vehicles can continue to cross the tracks and possibly stop on the tracks. However, the track clearance green interval has already expired and there will be no further opportunity to clear. This potentially hazardous condition is called the "preempt trap" and is described in more detail in TxDOT Project Bulletin 1752-9: The Preempt Trap: How to Make Sure You Do Not Have One.

The Clearing of Clear Storage Distance section (lines 45 to 50) focuses on efficiency by calculating duration of the track clearance green interval that is needed to clear the clear storage distance (CSD in Figure 1), or a specific portion thereof.

Preempt Trap Check

Line 36. Advance preemption time provided is the duration (in seconds) the preempt sequence is active in the highway traffic signal controller before the activation of the railroad active warning devices. If Line 35 is zero (i.e. no additional warning time is required from the railroad), the value on Line 33 can be used. In other cases, use the actual value of the advance preemption time (APT) provided by the railroad. If no APT is provided, enter zero on Line 36.

Line 37. Multiplier for maximum APT due to train handling is a value that relates the maximum duration of the advance preemption time (APT) to the minimum value guaranteed by the railroad. Although the railroad guarantees a minimum duration for the APT, it is probable that in most cases the actual duration of the APT will be longer than the guaranteed duration. This variability in APT occurs due to "train handling", which a term that describes the acceleration and deceleration of trains on their approach to the crossing. If a train accelerates or decelerates while approaching to the crossing, the railroad warning system cannot estimate the arrival time of the train at the crossing accurately, resulting in variation in the actual duration of APT provided. This variation needs to be taken into account to ensure safe operation.

To make sure that the preempt trap does not occur we need to determine the maximum value of the APT so that a sufficiently long track clearance green interval can be provided to ensure that the gates block access to the crossing before the track clearance green ends. The maximum APT can be estimated by multiplying the advance preemption time provided (and guaranteed) by the railroad (Line 36) with the multiplier for maximum APT due to train handling. This value is only significant if the value for APT on Line 36 is non-zero. If APT is zero, continue to line 38.

In the case where APT is provided, the difference between the minimum and maximum values of APT is termed excess APT. Excess APT usually occurs when the train decelerates on the approach to the crossing, or where train handling affects the accuracy of the estimated time of train arrival at the crossing so that the preempt sequence is activated earlier than expected. The amount of excess APT is increased by the following conditions:

- Increased variation in train speeds, since more trains will be speeding up and slowing down;
- Lower train speeds, since a fixed deceleration rate has a greater effect on travel time at low speeds than at higher speeds; and
- Longer warning times, because more time is available for the train to decelerate on the approach to the crossing.

The multiplier for maximum APT can be determined from field measurements as the largest advance preemption time observed (or the 95th percentile, if enough observations are available) divided by the value on Line 36. If no field observations are available, the multiplier for maximum APT can be estimated as 1.60 if warning time variability is high or 1.25 if warning time variability is low. High warning time variability can typically be expected in the vicinity of switching yards, branch lines, or anywhere low-speed switching maneuvers takes place. According to Section 16.30.10 of the *AREMA Signal Manual* the railroad can provide a “timer for constant time between APT and CWT.” The effect of such a “not to exceed” timer is to eliminate excess APT, and if provided, the multiplier on Line 37 can be set to 1.0.

Line 38. Maximum APT is largest value (in seconds) of the advance preemption time that can typically be expected, which corresponds to the earliest possible time the preemption sequence in the traffic signal controller will be activated before the activation of the railroad grade crossing warning system (flashing lights and gates). It is calculated by multiplying the APT provided by the railroad (Line 36) with the multiplier for maximum APT due to train handling (Line 37).

Line 39. Minimum duration for the track clearance green is the minimum duration (in seconds) of the track clearance green interval to ensure that the gates block access to the crossing before the track clearance green expires in the case where no advance preemption time is provided. It is necessary to block access to the crossing before the track clearance green expires to ensure that vehicles do not enter the crossing after the expiration of the track clearance green and so be subject to the preempt trap (described in the introduction to Section 5).

The 15 seconds minimum duration for the track clearance green interval is calculated from Federal regulations and requirements of the *Texas MUTCD*. Section 8D.06 of the *Texas MUTCD* requires that flashing-light signals shall operate for at least 20 seconds before the arrival of any train (with certain exceptions), while Section 8D.04 requires that the gate arm shall reach its horizontal position at least 5 seconds before the arrival of the train. For simultaneous (non-advance) preemption, the preemption sequence starts at the same time as the flashing-light signals, so to ensure that the preempt trap does not occur, a track clearance green interval of at least 15 seconds is required.

Line 40. Gates down after start of preemption is the maximum duration (in seconds) from when the preempt is activated in the highway traffic signal controller until the gates reach a horizontal position. Calculate this value by adding the maximum advance preemption time on Line 38 to the minimum duration for the track clearance green interval on Line 39.

Line 41. Preempt verification and response time, recorded on Line 3, is the number of seconds between the receipt at the controller unit of a preempt call issued by the railroad’s grade crossing warning equipment and the time the controller software actually begins to respond to the preempt call.

Line 42. Best-case conflicting vehicle or pedestrian time (in seconds) is the minimum time from when the preempt starts to time in the controller (i.e. after verification and response) until the track clearance green interval can start timing. In most cases, this value is zero, since the controller may already be in the track clearance phase(s) when the preempt starts timing, and therefore the track clearance green interval can start timing immediately. The best-case conflicting vehicle or pedestrian time may be greater than zero if the track clearance green interval contains phases that are not in normal operation (and conflicts with the normal phases), or where another phase or interval always has to terminate before the track clearance green interval can start timing.

Line 43. Minimum right-of-way transfer time is the minimum amount of time needed for the best case condition, prior to display of the track clearance green interval. Calculate the minimum right-of-way transfer time by adding lines 41 and 42.

Line 44. Calculate the **Minimum track clearance green time** by subtracting Line 43 from Line 40. This yields the minimum time that the track clearance green interval has to be active to avoid the preempt trap.

Clearing of Clear Storage Distance

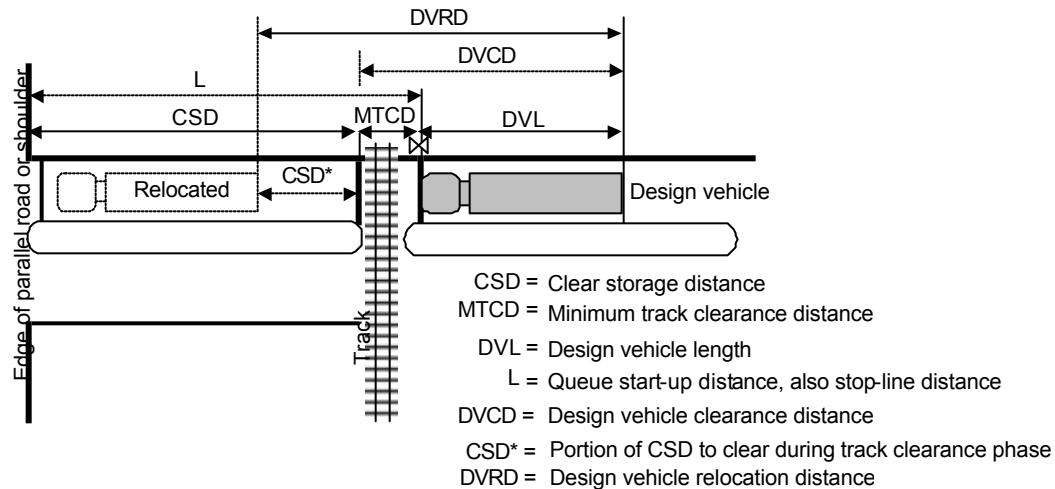

Figure 3 Relocation distances during the track clearance green interval.

Line 45. Time required for design vehicle to start moving, recorded on Line 22, is the number of seconds that elapses between the start of the track clearance green interval and the time the design vehicle, which is located at the edge of the railroad crossing on the opposite side from the signalized intersection, begins to move.

Line 46. Design vehicle clearance distance (DVCD in Figure 3) is the length, in feet, which the design vehicle must travel in order to enter and completely pass through the railroad crossing's minimum track clearance distance (MTCD). This is the same value as recorded on Line 23.

Line 47. Portion of CSD to clear during track clearance, (CSD* in Figure 3) is the portion of the clear storage distance (CSD), in feet, that must be cleared of vehicles before the track clearance green interval ends. For intersections with a CSD greater than approximately 150 feet it is desirable—but not necessary—to clear the full CSD during the track clearance green interval. In other words, it is desirable to set Line 47 to the full value of CSD (Line 18). If the full CSD is not cleared, however, vehicles will be stopped in the CSD during the preempt dwell period, and if not serviced during the preempt dwell period, will be subject to unnecessary delays which may result in unsafe behavior. For CSD values less than 150 feet the full CSD is typically cleared to avoid the driver task of crossing the tracks followed immediately by the decision to stop or go when presented by a yellow signal as the track clearance green interval terminates.

Line 48. Design vehicle relocation distance (DVRD in Figure 3) is the distance, in feet, that the design vehicle must accelerate through during the track clearance green interval. It is the sum of the design vehicle clearance distance (Line 46) and the portion of CSD to clear during the track clearance green interval (Line 47).

Line 49. The **Time required for design vehicle to accelerate through DVRD** is the amount of time required for the design vehicle to accelerate from a stop and travel the complete design vehicle relocation distance (DVRD). This time value, in seconds, can be found by locating your design vehicle relocation distance from Line 48 on the horizontal axis of Figure 2 and then drawing a line straight up until that line intersects the acceleration time performance curve for your design vehicle. For a WB-50 semi-trailer, large school bus (S-BUS 40), or single unit (SU) vehicle, multiply the acceleration time with a correction factor obtained from Table 2 to estimate the effect of grade on the acceleration of the vehicle. Use the average grade over the design vehicle relocation distance. For design vehicle relocation distances greater than 400 feet, use Equation 1 with the appropriate parameters listed in Table 3.

Line 50. Time to clear portion of clear storage distance, in seconds, is the total amount of time required (after the signal has turned green for the approach crossing the tracks) to begin moving a queue of vehicles through the queue start-up distance (L in Figure 3) and then move the design vehicle from a stopped position at the far side of the crossing completely through the portion of clear storage distance that must be cleared (CSD* in Figure 3). This value is the sum of the time required for design vehicle to start moving (Line 45) and the time for the design vehicle to accelerate through the design vehicle relocation distance, DVRD (Line 49).

Line 51. The Track clearance green interval is the time required, in seconds, for the track clearance green interval to avoid the occurrence of the preempt trap and to provide enough time for the design vehicle to clear the portion of the clear storage distance specified on Line 47. The track clearance green interval time is the maximum of the minimum track clearance green time (Line 44) and the time required to clear a portion of clear storage distance (Line 50).

SECTION 6: VEHICLE-GATE INTERACTION CHECK (OPTIONAL)

Note: This section is optional and is used to calculate the required advance preemption time to avoid the automatic gates descending on a stationary or slow moving design vehicle as it moves through the minimum track clearance distance (MTCD). If this worksheet is only used to determine if additional warning time has to be requested from the railroad to ensure that vehicles have enough time to clear the crossing before the arrival of the train, this section need not be completed.

Line 52. Right-of-way transfer time, in seconds, recorded on Line 17, is the maximum amount of time needed for the worst case condition, prior to display of the track clearance green interval.

Line 53. Time required for design vehicle to start moving, recorded on Line 22, is the time (in seconds) elapsed between the start of the track clearance green interval and the time the design vehicle, which is located at the edge of the railroad crossing on the opposite side from the signalized intersection, begins to move.

Line 54. Time required for design vehicle to accelerate through the design vehicle length, DVL, is the time required for the design vehicle to accelerate through its own length. The design vehicle length is recorded on Line 20. This time value, in seconds, can be read from Figure 2 and Table 2 or looked up in Table 4 for standard design vehicles. For a WB-50 semi-trailer, large school bus, or single unit (SU) truck use the average grade over the design vehicle length at the far side of the crossing.

Line 55. Time required for design vehicle to clear the descending gates, in seconds, is the sum of the right-of-way transfer time on Line 52, the time required for design vehicle to start moving on Line 53, and the time required for design vehicle to accelerate through the design vehicle length on Line 54.

Line 56. Duration of flashing lights before gate descent start, in seconds, is the time the railroad warning lights flash before the gates start to descend. This value typically ranges from 3 to 5 seconds and must be obtained from the railroad. The value obtained from the railroad may be verified using field observation.

Table 4. Time required for the design vehicle to accelerate through the design vehicle length.

Design Vehicle	Design Vehicle Length (feet)	Grade	Acceleration Time (seconds)
Through Passenger Car	19	Level	2.6
Left Turning Passenger Car	19	Level	2.7
Single Unit Truck (SU)	30	Level to 2%	3.8
		4%	4.0
		6%	4.3
		8%	4.6
Large School Bus (S-BUS 40)	40	Level to 1%	5.5
		2%	5.5
		4%	6.1
		6%	6.6
Intermediate Semi-Trailer (WB-50)	55	Level	10.0
		2%	11.0
		4%	12.8
		6%	14.4
		8%	15.8

Line 55. Time required for design vehicle to clear the descending gates, in seconds, is the sum of the right-of-way transfer time on Line 52, the time required for design vehicle to start moving on Line 53, and the time required for design vehicle to accelerate through the design vehicle length on Line 54.

Line 56. Duration of flashing lights before gate descent start, in seconds, is the time the railroad warning lights flash before the gates start to descend. This value typically ranges from 3 to 5 seconds and must be obtained from the railroad. The value obtained from the railroad may be verified using field observation.

Line 57. Full gate descent time, in seconds, is the time it takes for the gates to descend to a horizontal position after they start their descent. This value must be obtained from the railroad and may be verified using field observation. In the case where multiple gates descend at different speeds, use the descent time of the gate that reaches the horizontal position first.

Line 58. The Proportion of non-interaction gate descent time is the decimal proportion of the full gate descent time on Line 57 during which the gate will not interact with (i.e. not hit) the design vehicle if it is located under the gate. This value depends on the design vehicle height, h , and the distance from the center of the gate mechanism to the nearest side of the design vehicle, d , as shown in Figure 4. Figure 5 can be used to determine the proportion of non-interaction gate descent time. Select the distance from the center of the gate mechanism to the nearest side of the design vehicle, d , on the vertical axis of Figure 5, draw a horizontal line until you reach the curve that represents the design vehicle, and then draw a vertical line down to the horizontal axis and read off the value of the proportion of non-interaction gate descent time.

Line 59. Non-interaction gate descent time is time (in seconds) during gate descent that the gate will not interact with (i.e. not hit) the design vehicle if it is located under the gate. In other words, it is the time that expires after the gate starts to descend until it hits the design vehicle if it is located under the gate. This value is calculated by multiplying the full gate descent time on Line 57 with the proportion of non-interaction gate descent time on Line 58.

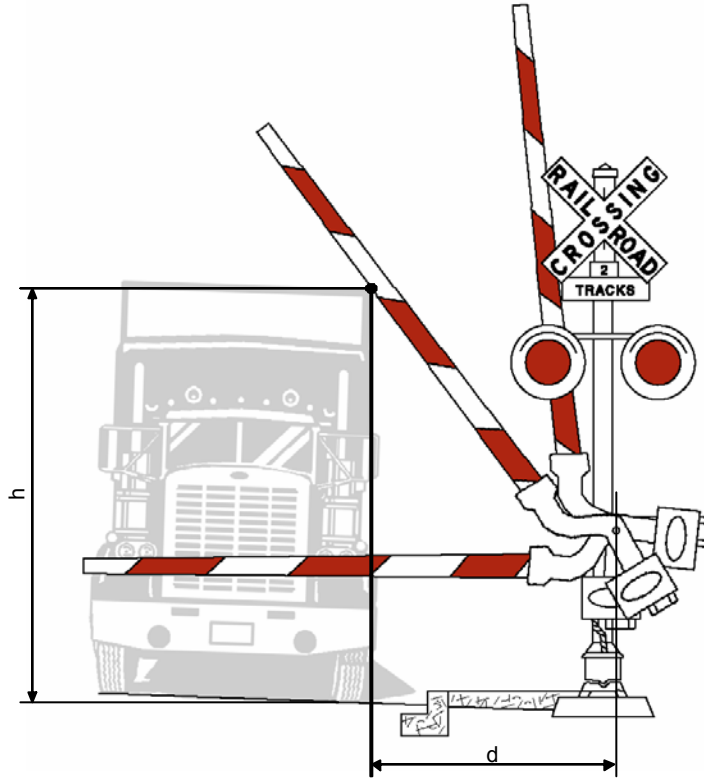

Figure 4 Gate interaction with the design vehicle.

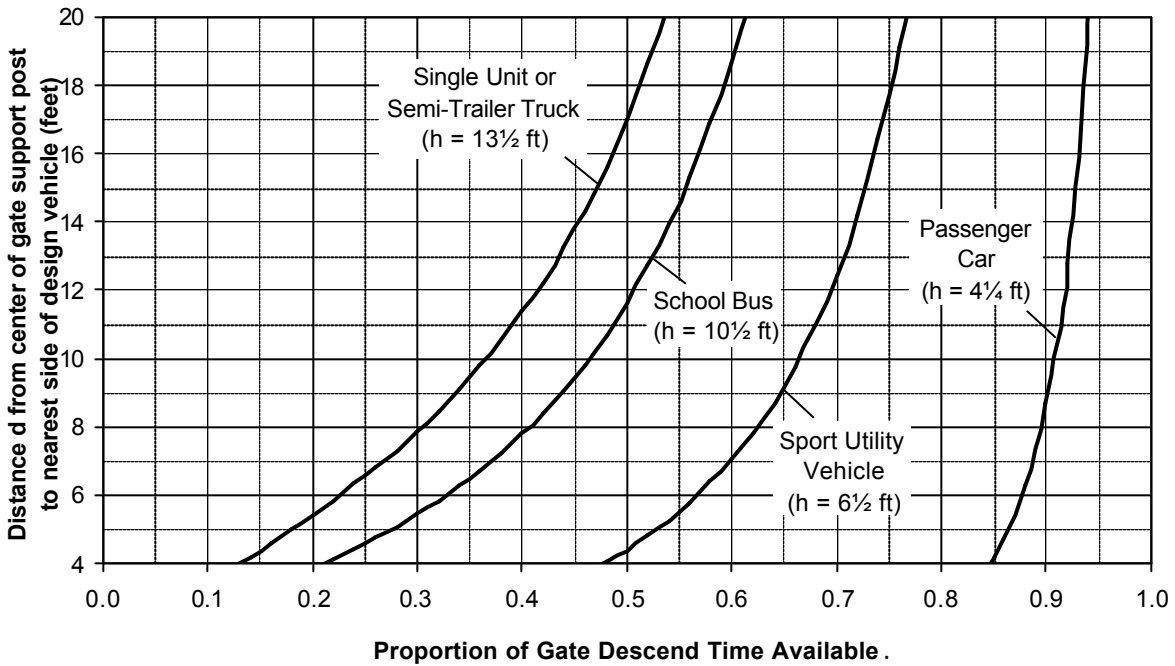

Figure 5 Proportion of gate descent time available as a function of the design vehicle height and the distance from the center of the gate mechanism to the nearest side of the design vehicle.

Line 60. Time available for design vehicle to clear descending gate, in seconds, is the time, after the railroad warning lights start to flash, that is available for the design vehicle to clear the descending gate before the gate hits the vehicle. It is the sum of the duration of the flashing lights before gate descent start (Line 56) and the non-interaction gate descent time (Line 59).

Line 61. Advance preemption time required to avoid design vehicle-gate interaction, in seconds, is calculated by subtracting the time available for the design vehicle to clear descending gate (Line 60) from the time required for the design vehicle to clear descending gate (Line 55). The result is the amount of advance preemption time that is required to avoid the gates descending on a stationary or slow-moving design vehicle. If the result of the subtraction is equal to or less than zero, it means that sufficient time is available, and you should enter zero (0) on Line 61. If the result is greater than the amount of advance preemption time provided by the railroad, as given on Line 36, there is a possibility that the gates could descend on a stationary or slow-moving design vehicle. To avoid this situation, additional advance preemption time should be requested from the railroad.

It should be kept in mind that on its own, gates descending on a vehicle is not a critical safety failure, because enough time still exists to clear the crossing before the arrival of the train, if the advance preemption time on Line 36 is provided. Therefore, local policies may vary on whether additional advance preemption time (over and above that on Line 36) should be requested solely for the purpose of prohibiting gates descending on vehicles.

If additional advance preemption time is provided to avoid design vehicle-gate interaction, Line 33 of this Worksheet has to be updated, and Lines 34 and 35 recomputed. Section 5 also needs to be recomputed to calculate the track clearance green time.

REFERENCES

The following references were used in the development of the *2003 Guide For Determining Time Requirements For Traffic Signal Preemption At Highway-Rail Grade Crossings* and these accompanying Instructions.

Texas Department of Transportation. *Texas Manual on Uniform Traffic Control Devices (MUTCD)*. 2003. On the Internet at <http://www.dot.state.tx.us/TRF/mutcd.htm>. Link valid May 2003.

Institute of Transportation Engineers (ITE). *Determining Vehicle Signal Change and Clearance Intervals*. An Informational Report prepared by ITE Technical Council Task Force 4TF-1, August 1994.

American Association of State Highway & Transportation Officials (AASHTO). *A Policy on Geometric Design of Highways and Streets*. (Green Book). 2001.

Marshall, P.S. and W.D. Berg. *Design Guidelines for Railroad Preemption at Signalized Intersections*. In ITE Journal Volume 67, Number 2, February 1997, pp. 20-25.

American Railway Engineering and Maintenance-of-Way Association (AREMA). *Manual of Recommended Practices-Signals*. 2000.

Engelbrecht, R.J., S. Sunkari, T. Urbanik, and K. Balke. *The Preempt Trap: How to Make Sure You do Not Have One*. Texas Department of Transportation Project Bulletin 1752-9, October, 2000. On the Internet at <http://tti.tamu.edu/product/catalog/reports/1752-9.pdf>. Link valid May 2003.



Texas Department of Transportation
GUIDE FOR DETERMINING TIME REQUIREMENTS FOR
TRAFFIC SIGNAL PREEMPTION AT HIGHWAY-RAIL GRADE CROSSINGS

City _____
 County _____
 District _____

Date _____
 Completed by _____
 District Approval _____



Show North Arrow

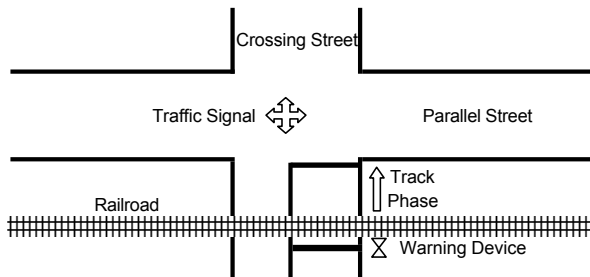

Parallel Street Name _____
 Crossing Street Name _____

Railroad _____
 Crossing DOT# _____

Railroad Contact _____
 Phone _____

SECTION 1: RIGHT-OF-WAY TRANSFER TIME CALCULATION

Preempt verification and response time

- 1. Preempt delay time (seconds) 1.
- 2. Controller response time to preempt (seconds) 2.
- 3. Preempt verification and response time (seconds): add lines 1 and 2 3.

Remarks

 Controller type: _____

Worst-case conflicting vehicle time

- 4. Worst-case conflicting vehicle phase number 4.
- 5. Minimum green time during right-of-way transfer (seconds) 5.
- 6. Other green time during right-of-way transfer (seconds) 6.
- 7. Yellow change time (seconds) 7.
- 8. Red clearance time (seconds) 8.
- 9. Worst-case conflicting vehicle time (seconds): add lines 5 through 8 9.

Remarks

Worst-case conflicting pedestrian time

- 10. Worst-case conflicting pedestrian phase number 10.
- 11. Minimum walk time during right-of-way transfer (seconds) 11.
- 12. Pedestrian clearance time during right-of-way transfer (seconds) 12.
- 13. Vehicle yellow change time, if not included on line 12 (seconds) 13.
- 14. Vehicle red clearance time, if not included on line 12 (seconds) 14.
- 15. Worst-case conflicting pedestrian time (seconds): add lines 11 through 14 15.

Remarks

Worst-case conflicting vehicle or pedestrian time

- 16. Worst-case conflicting vehicle or pedestrian time (seconds): maximum of lines 9 and 15 16.
- 17. Right-of-way transfer time (seconds): add lines 3 and 16 17.

SECTION 2: QUEUE CLEARANCE TIME CALCULATION

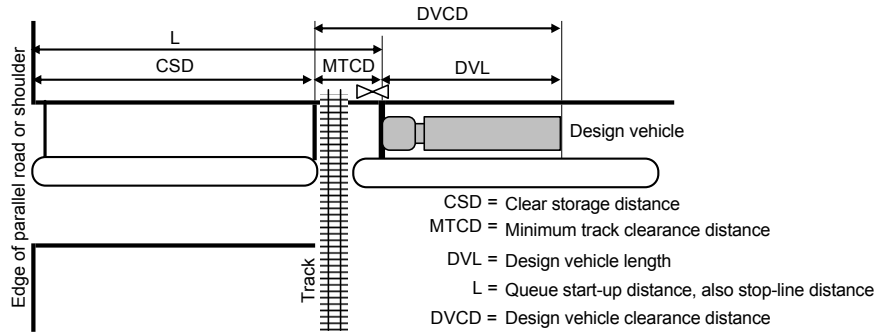

18. Clear storage distance (CSD, feet)	18.	<input type="text"/>	Remarks _____	
19. Minimum track clearance distance (MTCD, feet)	19.	<input type="text"/>		
20. Design vehicle length (DVL, feet)	20.	<input type="text"/>		Design vehicle type: _____
21. Queue start-up distance, L (feet): add lines 18 and 19	21.	<input type="text" value="0"/>	Remarks _____	
22. Time required for design vehicle to start moving (seconds): calculate as $2+(L\div 20)$	22.	<input type="text" value="0.0"/>		
23. Design vehicle clearance distance, DVCD (feet): add lines 19 and 20	23.	<input type="text" value="0"/>		
24. Time for design vehicle to accelerate through the DVCD (seconds)	24.	<input type="text"/>		Read from Figure 2 in Instructions.
25. Queue clearance time (seconds): add lines 22 and 24	25.	<input type="text" value="0.0"/>		

SECTION 3: MAXIMUM PREEMPTION TIME CALCULATION

26. Right-of-way transfer time (seconds): line 17	26.	<input type="text" value="0.0"/>	Remarks _____
27. Queue clearance time (seconds): line 25	27.	<input type="text" value="0.0"/>	
28. Desired minimum separation time (seconds)	28.	<input type="text" value="4.0"/>	
29. Maximum preemption time (seconds): add lines 26 through 28	29.	<input type="text" value="4.0"/>	

SECTION 4: SUFFICIENT WARNING TIME CHECK

30. Required minimum time, MT (seconds): per regulations	30.	<input type="text" value="20.0"/>	Remarks _____	
31. Clearance time, CT (seconds): get from railroad	31.	<input type="text"/>		
32. Minimum warning time, MWT (seconds): add lines 30 and 31	32.	<input type="text" value="20.0"/>		Excludes buffer time (BT)
33. Advance preemption time, APT, if provided (seconds): get from railroad ..	33.	<input type="text"/>		
34. Warning time provided by the railroad (seconds): add lines 32 and 33	34.	<input type="text" value="20.0"/>		
35. Additional warning time required from railroad (seconds): subtract line 34 from line 29, round up to nearest full second, enter 0 if less than 0	35.	<input type="text" value="0"/>		

If the additional warning time required (line 35) is greater than zero, additional warning time has to be requested from the railroad. Alternatively, the maximum preemption time (line 29) may be decreased after performing an engineering study to investigate the possibility of reducing the values on lines 1, 5, 6, 7, 8, 11, 12, 13 and 14.

Remarks: _____

SECTION 5: TRACK CLEARANCE GREEN TIME CALCULATION (OPTIONAL)

Preempt Trap Check

36. Advance preemption time (APT) provided (seconds):	36.	<input type="text"/>	Line 33 only valid if line 35 is zero.
37. Multiplier for maximum APT due to train handling	37.	<input type="text"/>	See Instructions for details.
38. Maximum APT (seconds): multiply line 36 and 37	38.	<input type="text" value="0.0"/>	Remarks
39. Minimum duration for the track clearance green interval (seconds)	39.	<input type="text" value="15.0"/>	<u>For zero advance preemption time</u>
40. Gates down after start of preemption (seconds): add lines 38 and 39	40.	<input type="text" value="15.0"/>	
41. Preempt verification and response time (seconds): line 3	41.	<input type="text" value="0.0"/>	Remarks
42. Best-case conflicting vehicle or pedestrian time (seconds): usually 0.....	42.	<input type="text"/>	_____
43. Minimum right-of-way transfer time (seconds): add lines 41 and 42	43.	<input type="text" value="0.0"/>	
44. Minimum track clearance green time (seconds): subtract line 43 from line 40	44.	<input type="text" value="15.0"/>	

Clearing of Clear Storage Distance

45. Time required for design vehicle to start moving (seconds), line 22	45.	<input type="text" value="0.0"/>	
46. Design vehicle clearance distance (DVCD, feet), line 23	46.	<input type="text" value="0"/>	Remarks
47. Portion of CSD to clear during track clearance phase (feet) ...	47.	<input type="text"/>	<u>CSD* in Figure 3 in Instructions.</u>
48. Design vehicle relocation distance (DVRD, feet): add lines 46 and 47	48.	<input type="text" value="0"/>	
49. Time required for design vehicle to accelerate through DVRD (seconds)	49.	<input type="text"/>	Read from Figure 2 in Instructions.
50. Time to clear portion of clear storage distance (seconds): add lines 45 and 49	50.	<input type="text" value="0.0"/>	
51. Track clearance green interval (seconds): maximum of lines 44 and 50, round up to nearest full second	51.	<input type="text" value="15"/>	

SECTION 6: VEHICLE-GATE INTERACTION CHECK (OPTIONAL)

52. Right-of-way transfer time (seconds): line 17	52.	<input type="text" value="0.0"/>	
53. Time required for design vehicle to start moving (seconds), line 22	53.	<input type="text" value="0.0"/>	
54. Time required for design vehicle to accelerate through DVL (on line 20, seconds)	54.	<input type="text"/>	Read from Table 3 in Instructions.
55. Time required for design vehicle to clear descending gate (seconds): add lines 52 though 54	55.	<input type="text" value="0.0"/>	Remarks
56. Duration of flashing lights before gate descent start (seconds): get from railroad	56.	<input type="text"/>	_____
57. Full gate descent time (seconds): get from railroad	57.	<input type="text"/>	Remarks
58. Proportion of non-interaction gate descent time	58.	<input type="text"/>	Read from Figure 5 in Instructions.
59. Non-interaction gate descent time (seconds): multiply lines 57 and 58	59.	<input type="text" value="0.0"/>	
60. Time available for design vehicle to clear descending gate (seconds): add lines 56 and 59	60.	<input type="text" value="0.0"/>	
61. Advance preemption time (APT) required to avoid design vehicle-gate interaction (seconds): subtract line 60 from line 55, round up to nearest full second, enter 0 if less than 0	61.	<input type="text" value="0"/>	

Policy On Private Crossings, West Virginia Example

May 2006

TO: Division Directors
District Engineers

FROM: Marvin Murphy

SUBJECT: Adding or Improving Highway Rail-Grade
Crossings

The Division of Highways is frequently faced with situations where it is necessary or desirable to add one or more highway-rail at-grade crossings to the State Highway System. The addition of these crossings can take several forms. It is the intent of this memorandum to distinguish between the situations which may arise and to prescribe appropriate actions to be taken in each.

The decision to construct a new highway-rail crossing, or to redesignate an existing private crossing as public, must not be taken lightly. Careful consideration must be given to balancing public convenience; public necessity; potential adverse effects on both highway and railroad operations; and safety.

Adoption or redesignation of a crossing may have significant consequences. There are differences between the responsibilities of the Division of Highways and of the railroad depending on whether a highway-railroad crossing is public or private, and on the crossing's antecedents. For instance, a private crossing agreement ordinarily requires an annual fee for maintenance and insurance; has a cancellation clause; and specifies that the other party to the agreement will be financially responsible for any physical improvements or additional traffic control devices which the railroad may determine to be necessary.

A private crossing:

- Represents a relationship between the railroad company and the party or parties served by the crossing.
- May exist due to various circumstances, such as a deed, agreement, or a prescriptive right.
- Carries no responsibility for the railroad or for the division of highways to install any traffic control devices.
- Does not require the engineer to sound a whistle or bell.
- May be blocked for any period of time necessary to allow trains to be held, to switch, or to pass.
- Needs to be maintained only to the standard required for the user or users to be able to cross.

A public crossing, on the other hand, imposes certain duties on the division of highways and on the railroad:

- The division of highways must install advance warning signs, pavement markings (if appropriate), and any other traffic control devices which may be recommended after an engineering study.
- The division of highways is responsible for the routine maintenance of the crossing approaches beyond the outer ends of the

cross-ties, even though the highway is within the railroad right of way (If the track elevation or the roadway at the crossing is changed, the party making the change is responsible for providing runoffs or other corrective measures).

- The division of highways is responsible for 100 percent of the engineering and construction costs of active traffic control devices (flashing lights, or flashing lights and gates) if they are needed at the crossing.
- Once active traffic control devices have been installed, the railroad assumes ownership of them and is responsible for all continuing power and maintenance costs in perpetuity.
- If active traffic control devices are not present, the railroad must install “. . . Signboards or notices . . . Of the design and construction and . . . Located in the manner required or approved by the state road commission” (West Virginia code, §31-2-9).
- The railroad engineer must sound the whistle when approaching the crossing (West Virginia code, §31-2-8 and 49 cfr §222.21).
- The crossing may not be blocked by a standing train, or by a train engaged in switching, loading, or unloading operations for a period of more than 10 minutes (West Virginia code, §31-2a-2).
- The railroad has an absolute and non-delegable duty to keep and maintain the crossing surface in a reasonably safe condition (West Virginia code, §17-4-8 and §17-16-8).
- Additional liability may accrue to the railroad in case of an accident.

The responsible Division of Highways organization should ascertain the speed, frequency, and nature of train operations at and near the site at which a crossing is proposed for construction or redesignation. Crossings should not be added or redesignated where highway traffic would be impeded by frequent train movements or by stopped or slow-moving trains. Particular locations to be avoided include areas within or in the vicinity of rail yards and terminals; industrial trackage or switching yards; tracks used for meeting or passing trains; areas where “helper” locomotives are used or are added to or removed from trains; and areas where trains are held short of yards, terminals, railroad junctions, or to avoid blocking other public crossings.

Before any highway-railroad crossing is added to the State Highway System, the responsible organization must contact the Railroad and Utilities Section of Engineering Division to confirm the public or private

status of the crossing and to permit the initiation of an appropriate railroad agreement, if required.

The following paragraphs discuss the most common situations:

1. **A public highway-railroad crossing is being added as a result of a construction or reconstruction project by the Division of Highways:** The decision to cross any rail line with a new or improved public crossing at grade should not be taken lightly. The immediate and long-term costs of such a decision can be very high. There will be immediate dollar costs for right of way and construction and for the railroad’s prospective costs for the operation and maintenance costs of the new or upgraded traffic control devices and of the crossing itself. There will be daily road user costs for train delays, and as vehicles slow and speed up in traversing the crossing. There will be larger, periodic road user costs as the crossing must be closed or restricted for railroad track and crossing surface maintenance.

As a condition of approving the installation of a new public crossing, the affected railroad may request that two or more public crossings be closed. The roadway system throughout the immediate area should be reviewed during project development. Quite often, traffic on some number of roadways in relative close proximity to the new crossing can be diverted to it or to other points of access without sacrificing convenience. These common points of access can then be upgraded to improve traffic operations and to reduce the number of major intersections or other potential points of conflict.

2. **A public highway-railroad crossing is being added under or in cooperation with a project for an industrial access road, school access road, or similar improvement:** Unlike the case described above, such a crossing will not ordinarily carry through traffic. An at-grade highway-rail crossing may be the only feasible method of access to a site due to topography or other constraints; or, in the case of an industrial park, rail service may be necessary to the viability of the park or to one or more tenants.

Many of the circumstances cited above will apply. There will be immediate dollar costs

for right of way and construction and for the railroad's prospective costs for the operation and maintenance costs of the traffic control devices and of the crossing itself. There will be daily road user costs for train delays, and as vehicles slow and speed up in traversing the crossing. There will be larger, periodic road user costs as the crossing must be closed or restricted for railroad track and crossing surface maintenance. As a condition of approving a new public crossing, the affected railroad may request that two or more public crossings be closed as a condition of approving the installation of the new crossing.

3. **A road that crosses a railroad via an existing public highway-railroad crossing is adopted into the State Highway System:** This situation most commonly occurs when an existing public road that has not previously been adopted by the Division of Highways is added to the State Highway System. The addition may be for purposes of maintenance, or may be necessary to permit the upgrading of the crossing and approaches as part of a project or to facilitate a safety improvement. In this instance, many of the responsibilities and burdens listed above have already fallen upon the railroad.
4. **A road that crosses a railroad via an existing private highway-railroad grade crossing is adopted into the State Highway System:** As noted earlier, a private highway-railroad grade crossing represents a relationship between the railroad company and the party or parties served by the crossing.

Before the road and crossing are adopted, it is essential that the type of right of way occupied by the railroad (title in fee, title in fee for rail purposes, or easement) and the antecedents of the crossing (deed, agreement, prescriptive right, etc.) be known. This will permit a more complete assessment of the legal status of the crossing and will assist in negotiating and preparing an appropriate agreement.

When adopting a road into the State Highway System, the railroad company must be accorded the same status as the other property owners. Also, the adoption of the crossing may result in significant financial, operational, and liability burdens on the railroad and on the Division of Highways. The company may resist the adoption of the crossing; may request that they be compensated for the right of way, plus damages and prospective costs; or, in rare cases, may request that the Division of Highways assume the responsibilities and costs included under an existing private crossing agreement.

Railroads have not always been considered in past road redesignations or adoptions. This omission can make our day-to-day dealings with the railroads regarding other mutual concerns more difficult, and may expose the railroad and the Division of Highways to increased liability in case of an accident.

In summary, it is necessary to exercise a high standard of care when considering a railroad crossing for adoption into the State Highway System.

List of Highway-Rail Grade Crossing Studies,

U.S. Department of Transportation,
Federal Railroad Administration
July 2005

APPENDIX

K

Reports with an NTIS order number may be ordered from National Technical Information Service, 5285 Port Royal Road, Springfield, Virginia 22161. Telephone: (703) 605-6000 or 1-800-553-6847. Prices on the last page are effective as of August 2004 and are subject to change thereafter. There is a \$5 handling charge per order or a \$25 charge per document for rush orders. Document prices may change depending on the document. For other reports, a more comprehensive listing may be found in Bibliographies 57 and 58, available from the Transportation Research Board, Washington, DC 20418.

Reports that indicate they are available from the Federal Railroad Administration (FRA) Safety Website can be found at safetydata.fra.dot.gov/officeofsafety/. Click on the “Forms and Publications” tab.

Additional crossing safety issues, information, rulemaking, references, and reports can be found on FRA’s Website at www.fra.dot.gov. Click on “Safety” and “Publications” or “Safety” and then “Highway-Rail Grade Crossing and Trespassing Prevention Division.”

Published FRA Reports	NTIS order no.	Price code
(See last page for prices.)		
1. A Program Definition Study for Rail-Highway Grade Crossing Improvement Prepared by Alan M. Voorhees and Associates, Inc. Report FRA-RP-70-2, October 1969	PB 190401	A08
2. The Visibility and Audibility of Trains Approaching Rail-Highway Grade Crossings Prepared by Systems Consultants, Inc. Report FRA-RP-71-1, May 1971	PB 202668	A08
3. Technological Innovation in Grade Crossing Protective Systems Prepared by TSC for FRA Report DOT-TSC-71-3, June 1971	PB 201624	A05
4. Report to Congress: Railroad-Highway Safety Part I: A Comprehensive Statement of the Problem Part II: Recommendations for Resolving the Problem Prepared jointly by the staffs of FRA and FHWA November 1971 and August 1972	PB 206792 PB 213115	A07 A06
5. Human Factors Countermeasures to Improve Highway-Railway Intersection Safety Prepared by Bio Technology, Inc. for FRA and NHTSA Report DOT-HS-800888, July 1973, 235 pp.	PB 223416	A11
6. Enhancement of Train Visibility Prepared by TSC for FRA Report FRA-ORD&D-74-15, September 1973	PB 223899	A05
7. Grade Crossing Protection in High-Speed, High-Density, Passenger-Service Rail Corridors Prepared by TSC for FRA Report FRA-ORD&D-74-14, September 1973	PB 223738	A03
8. Proceedings, 1974 National Conference on Railroad-Highway Crossing Safety Sponsored by U.S. Department of Transportation, U.S. Air Force Academy, August 19–22, 1974	PB 245231	A06
9. State Grade Crossing Programs: A Case Study Prepared for FRA/TSC by CONSAD Research Corp. Report FRA-ORD&D-75-8, September 1974	PB 244175	A04
10. Feasibility Study of In-Vehicle Warning Systems Prepared by Tracor-Jitco for NHTSA/FRA Report DOT-HS-256-3-752, May 1975	PB 242462	A07
11. Field Evaluation of Locomotive Conspicuity Lights Prepared by TSC for FRA Report FRA-ORD&D-75-54, May 1975	PB 244532	A04

12. Guidelines for Enhancement of Visual Conspicuity of Trains at Grade Crossings Prepared by TSC for FRA Report FRA-ORD&D-75-71, May 1975	PB 244551	A04
13. A Communication-Link Approach to Actuation of Grade Crossing Motorist Warning Systems Prepared by TSC for FRA Report FRA-ORD&D-75-80, July 1975	PB 244584	A06
14. A Methodology for Determination of Grade Crossing Resource Allocation Guidelines Prepared by TSC for FRA Report FRA-ORD&D-76-04, August 1975	PB 259005	A04
15. Locomotive to Automobile Baseline Crash Tests Prepared by Ultra Systems for FRA Report FRA-ORD&D-76-03, August 1975	PB 250564	A07
16. Lightning and Its Effects on Railroad Signal Circuits Prepared by University of Lowell for FRA/TSC Report FRA-ORD&D-76-129, December 1975	PB 250621	A06
17. Standby Power for Railroad-Highway Grade Crossing Warning Systems Prepared by University of Lowell for FRA/TSC Report FRA-ORD&D 76-286, September 1976	PB 263592	A03
18. Improvement of the Effectiveness of Motorist Warnings at Railroad-Highway Grade Crossings Prepared by TSC for FRA Report FRA/ORD-77-07, February 1977	PB 266784	A05
19. Potential Means at Cost Reduction in Grade Crossing Automatic Gate Systems Prepared by MB Associates et. al for TSC/FRA Reports FRA/ORD-77-06.I and 77/06.II, February 1977	PB 265724 PB 265725	A05 A04
20. Summary Statistics of the National Railroad-Highway Crossing Inventory for Public At-Grade Crossings Prepared by TSC for FRA Report OOPD-77-8, June 1977	PB 271334	A08
21. Proceedings, 1977 National Conference on Railroad-Highway Crossing Safety Sponsored by U.S. Department of Transportation, University of Utah, August 23-25, 1977	PB 293071	A07
22. Innovative Concepts and Technology for Railroad-Highway Grade Crossing Motorist-Warning Systems Prepared by Cincinnati Electronics et. al for TSC/FRA Report FRA/ORD-77/37.I and 77/37.II, September 1977	PB 273354 PB 273355	A10 A05

23. Potential Means of Cost Reduction in Grade Crossing Motorist-Warning Control Equipment Prepared by Storch Engineers et. al for TSC/FRA Reports FRA/ORD-77/45.I and 77/45.II, December 1977	PB 277946 PB 277947	A09 A03
24. Analysis of NPRM Strobe Lights on Locomotives Prepared by IOCS, Inc. for FRA Report FRA/OPPD-79-4, May 1978	PB 293483	A04
25. A Study of State Programs for Rail-Highway Grade Crossing Improvements Prepared by TSC for FRA Report FRA-OPPD-78-7, June 1978	PB 279774	A08
26. Summary Statistics of the National Crossing Inventory for Public At-Grade Crossings, Second Edition Prepared by TSC for FRA Report FRA-OPPD-78-20, September 1978	PB 293070	A08
27. Legal Effects of Use of Innovative Equipment at Railroad-Highway Grade Crossings on Railroad's Accident Liability Prepared by TSC for FRA Report FRA-RRS-80-01, October 1979	PB 80-137888	A04
28. Rail-Highway Crossing Accident/Incident and Inventory Bulletin (No. 1 Calendar Year 1978) Prepared by Office of Safety, FRA, October 1979	Available from FRA	
29. Rail-Highway Crossing Hazard Prediction Research Results Prepared by TSC for FRA Report FRA-RRS-80-02, March 1980	PB 80-170749	A11
30. Identification and Evaluation of Off-Track Detection Systems for Grade Crossing Applications Prepared by GARD, Inc. Report FRA/ORD-80-32, April 1980	PB 80-186430	A06
31. Operational Testing of Locomotive-Mounted Strobe Lights Prepared by TSC for FRA Report DOT/TSC-FRA/ORD 80-48, June 1980	PB 80-224348	A03
32. The Effectiveness of Flashing Lights and Flashing Lights with Gates in Reducing Accident Frequency at Public Rail-Highway Crossings, 1975-1978 Prepared by Input Output Computer Services, Inc. for TSC/FRA/FHWA Report FRA-RRS-80-005, April 1980	PB 81-133886	A03

33. Rail-Highway Crossing Warning Device Life Cycle Cost Analysis Prepared by Input Output Computer Services, Inc. for TSC/FRA/FHWA Report FRA-RRS-80-003, September 1980	PB 81-133894	A05
34. Rail-Highway Crossing Accident/Incident Bulletin (No. 2 Calendar Year 1979) Prepared by Office of Safety, FRA, September 1980	Available from FRA	
35. Grade Crossing Accident Injury Minimization Study Prepared by Aerospace Design Company, Inc. Report FRA/ORD-80-87, December 1980	PB 81-155236	A09
36. Proceedings, 1980 National Rail-Highway Crossing Safety Conference Sponsored by U.S. Department of Transportation, University of Tennessee, June 17-19, 1980	PB 81-196982	A06
37. Investigation of Anomalous Rail-Highway Crossings Paper Presentation, 60th Annual Meeting of TRB Prepared by Office of Safety, FRA, January 1981	Available from FRA	
38. Rail-Highway Crossing Resource Allocation Model Prepared by TSC for FRA/FHWA Report FRA-RRS-81-001, April 1981	PB 81-212540	A05
39. Constant Warning Time Concept Development for Motorist Warning at Grade Crossings Prepared by Systems Technology Laboratory, Inc. Report FRA/ORD-81/07, May 1981	PB 81-205684	A09
40. Rail-Highway Crossing Accident/Incident and Inventory Bulletin (No. 3 Calendar Year 1980) Prepared by Office of Safety, FRA, June 1981	Available from FRA	
41. Operation Lifesaver National Symposium, August 27-29, 1981, Chicago, Illinois Prepared by Office of Safety, FRA, and National Safety Council, August 1981	PB 83-117234	A03
42. Rail-Highway Crossing Accident/Incident and Inventory Bulletin (No. 4 Calendar Year 1981) Prepared by Office of Safety, FRA, June 1982	Available from FRA See Item 56	
43. Summary of the Department of Transportation Rail-Highway Crossing Accident Prediction Formulas and Resource Allocation Model Prepared by Office of Safety, FRA, June 1982	PB 83-119057	A03
44. Freight Car Reflectorization Prepared by TSC for FRA Report FRA-RRS-83-1, December 1982	PB 84-131283	A06

<p>45. Rail-Highway Crossing Resource Allocation Procedure, User's Guide Prepared by TSC for FHWA and FRA Report FHWA-IP-82-7, December 1982</p>	<p>No longer available See FRA Item 57</p>	
<p>46. Compilation of State Laws and Regulations On Matters Affecting Rail-Highway Crossings Prepared by KSU for AAR, FRA and FHWA Report FHWA-TS-83-203, April 1983</p>	<p>No longer available See Item 108</p>	
<p>47. Rail-Highway Crossing Accident/Incident and Inventory Bulletin (No. 5 Calendar Year 1982) Prepared by Office of Safety, FRA, June 1983</p>	<p>Available from FRA</p>	
<p>48. Rail-Highway Crossing Accident/Incident and Inventory Bulletin (No. 6 Calendar Year 1983) Prepared by Office of Safety, FRA, June 1984</p>	<p>Available from FRA</p>	
<p>49. Accident Severity Prediction Formula for Rail-Highway Crossings Prepared by TSC for FRA and FHWA Report FHWA-RD-83/092, July 1984</p>	<p>PB 85-107167</p>	<p>A03</p>
<p>50. Rail-Highway Crossing Safety Report Prepared by FRA, July 1985</p>	<p>Available from FRA</p>	
<p>51. Rail-Highway Crossing Accident/Incident and Inventory Bulletin (No. 7 Calendar Year 1984) Prepared by Office of Safety, FRA, June 1985</p>	<p>Available from FRA</p>	
<p>52. Effectiveness of Motorist Warning Devices at Rail-Highway Crossings Prepared by FHWA and FRA Report DOT/TSC-FHWA-85-1, April 1985 Final Report</p>	<p>PB 882259901</p>	<p>A05</p>
<p>53. Rail-Highway Crossing Accident/Incident and Inventory Bulletin (No. 8 Calendar Year 1985) Prepared by Office of Safety, FRA, June 1986</p>	<p>Available from FRA</p>	
<p>54. Rail-Highway Crossing Resource Allocation Procedure, User's Guide, Second Edition Prepared by TSC for FRA and FHWA Report FHWA-IP-86-11, July 1986</p>	<p>No longer available See FRA Item 57</p>	
<p>55. Rail-Highway Crossing Accident/Incident and Inventory Bulletin (No. 9 Calendar Year 1986) Prepared by Office of Safety, FRA, June 1987</p>	<p>Available from FRA</p>	
<p>56. Summary of the DOT Rail-Highway Crossing Resource Allocation Procedure, Revised Prepared by TSC for FRA Report DOT/TSC-FRA-86-2, June 1987</p>	<p>PB 88-226287 FRA Safety Website</p>	<p>A03</p>

<p>57. Rail-Highway Crossing Resource Allocation Procedure, User's Guide, Third Edition Prepared by TSC for FRA Report DOT/TSC-FRA-87-1, August 1987</p>	<p>PB 88-225206/AS FRA Safety Website</p>	<p>A06</p>
<p>58. Rail-Highway Crossing Accident/Incident and Inventory Bulletin (No. 10 Calendar Year 1987) Prepared by Office of Safety, FRA, August 1988</p>	<p>Available from FRA</p>	
<p>59. Updated Compilation of States' Laws and Regulations Affecting Driver Behavior At Rail-Highway Crossings Prepared by COMSIS Corp., for FRA, FHWA Project DTFH61-88-Z-00145, February 1989</p>	<p>No longer available See FRA Item 108</p>	
<p>60. Rail-Highway Crossing Accident/Incident and Inventory Bulletin (No. 11 Calendar Year 1988) Prepared by Office of Safety, FRA, June 1989</p>	<p>Available from FRA</p>	
<p>61. An Evaluation of the TEXAS 1-800 Program Prepared by TTI and Richards and Associates for FRA, June 1989</p>	<p>Available from FRA</p>	
<p>62. Florida's Train Whistle Ban Prepared by Office of Safety, FRA, July 1990</p>	<p>Available from FRA</p>	
<p>63. Rail-Highway Crossing Accident/Incident and Inventory Bulletin (No. 12 Calendar Year 1989) Prepared by Office of Safety, FRA, June 1990</p>	<p>Available from FRA</p>	
<p>64. Rail-Highway Crossing Accident/Incident and Inventory Bulletin (No. 13 Calendar Year 1990) Prepared by Office of Safety, FRA, July 1991</p>	<p>Available from FRA</p>	
<p>65. Rail-Highway Crossing Accident/Incident and Inventory Bulletin (No. 14 Calendar Year 1991) Prepared by Office of Safety, FRA, July 1992</p>	<p>Available from FRA</p>	
<p>66. Florida's Train Whistle Ban, Second Edition Prepared by Office of Safety, FRA, September 1992</p>	<p>Available from FRA</p>	
<p>67. Trespasser Bulletin Volume I, Calendar Year 1991 Prepared by Office of Safety, FRA RRS-23, March 1993</p>	<p>Available from FRA</p>	
<p>68. Highway-Rail Crossing Accident/Incident and Inventory Bulletin (No. 15 Calendar Year 1992) Prepared by Office of Safety, FRA, August 1993</p>	<p>Available from FRA</p>	
<p>69. Trespasser Bulletin, Volume II, Calendar Year 1992 Prepared by Office of Safety, FRA RRS-23, November 1993</p>	<p>Available from FRA</p>	

<p>70. The Safety of Highway-Railroad Grade Crossings: Study of Acoustic Characteristics of Railroad Horn Systems Prepared by the FRA Office of Research and Development DOT/FRA/ORD - 93/25 and DOT-VNTSC-FRA-93-1, July 1993</p>	<p>Not available</p>
<p>71. Highway-Rail Crossing Safety Demonstrations – Final Report (9/30/92) Prepared by the FRA Office of Safety RRS-23, September 1993</p>	<p>Available from FRA</p>
<p>72. Rail-Highway Crossing Safety Action Plan Support Proposals Prepared by FRA, June 1994</p>	<p>Available from FRA</p>
<p>73. Rail-Highway Crossing Safety Action Plan Summary Prepared by FRA, June 1994</p>	<p>Available from FRA</p>
<p>74. Highway-Rail Crossing Accident/Incident and Inventory Bulletin (No. 16 Calendar Year 1993) Prepared by Office of Safety, FRA, July 1994</p>	<p>Available from FRA</p>
<p>75. Highway-Railroad Grade Crossings: A Guide To Crossing Consolidation and Closure Prepared by FRA and FHWA, July 1994</p>	<p>FRA Safety Website</p>
<p>76. Railroad Communications and Train Control: Report to Congress Prepared by Office of Safety, FRA, July 1994</p>	<p>Available from FRA</p>
<p>77. Trespasser Bulletin Volume III, Calendar Year 1993 Prepared by FRA Office of Safety RRS-23, September 1994</p>	<p>Available from FRA</p>
<p>78. The Use of Illumination at RR Grade Crossings to Reduce Collision Risks (Guidelines for Crossing Illumination) Prepared by FRA, Research and Special Programs Administration Report DOT-VNTSC-FRA-294-50, October 14, 1994</p>	<p>Available from FRA</p>
<p>79. Focus Group Study of Consumer Attitudes Toward Highway-Rail Grade Crossings Prepared for FHWA, FRA, FTA, and NHTSA by Global Exchange, Inc., November 1994</p>	<p>Available from FRA</p>
<p>80. Nationwide Study of Train Whistle Bans Prepared by Office of Safety, FRA, April 1995</p>	<p>Available from FRA</p>
<p>81. Highway-Rail Crossing Accident/Incident and Inventory Bulletin (No. 17 Calendar Year 1994) Prepared by Office of Safety, FRA, July 1995</p>	<p>FRA Safety Website</p>

<p>82. Safety of Highway-Railroad Grade Crossings Use of Auxiliary External Alerting Devices to Improve Locomotive Conspicuity Prepared by DOT Special Programs Administration for FRA, Office of Research and Development Report DOT-VNTSC-FRA-95-10, July 1995</p>	<p>Available from FRA Office of Research and Development</p>
<p>83. Highway-Railroad Grade Crossing Safety Research Needs Workshop (Summary of Results) Prepared by FRA, July 1995</p>	<p>Available from FRA</p>
<p>84. Compilation of State Laws and Regulations Affecting Highway-Rail Grade Crossings Prepared by Office of Safety, FRA, August 1995</p>	<p>Not Available See FRA Item 108</p>
<p>85. Florida's Train Whistle Ban Prepared by Office of Safety, FRA, October 1995</p>	<p>Available from FRA</p>
<p>86. Safety of Highway-Railroad Grade Crossings (Research Needs Workshop – Volume I) Prepared by DOT, Research and Special Programs Administration for FRA, Office of Research and Development Report DOT-VNTSC-FRA-95-12.1, January 1996</p>	<p>Available from FRA Office of Research and Development</p>
<p>87. Safety of Highway-Railroad Grade Crossings (Research Needs Workshop –Volume II – Appendices) Prepared by DOT, Research and Special Programs Administration for FRA, Office of Research and Development Report DOT-VNTSC-FRA-95-12.2, January 1996</p>	<p>PB 96183256 A20</p>
<p>88. Highway-Rail Crossing Accident/Incident and Inventory Bulletin (No. 18 Calendar Year 1995) Prepared by FRA Office of Safety RRS-23, September 1996</p>	<p>FRA Safety Website</p>
<p>89. Enhancing Rail Safety Now and Into the 21st Century: The Federal Railroad Administration's Safety Program and Initiatives – A Report to Congress Prepared by FRA, October 1996</p>	<p>Available from FRA</p>
<p>90. Highway-Rail Crossing Inventory Instructions and Procedure Manual Prepared by FRA, December 1996</p>	<p>FRA Safety Website</p>
<p>91. Highway-Rail Crossing Accident/Incident and Inventory Bulletin (No. 19 Calendar Year 1996) Prepared by Office of Safety, FRA, August 1997</p>	<p>FRA Safety Website</p>
<p>92. Model Legislation for Railroad Trespass and Railroad Vandalism Prepared by FRA, April 1998</p>	<p>FRA Safety Website</p>
<p>93. Field Evaluation of a Wayside Horn at a Highway-Railroad Grade Crossing Prepared by Volpe Center for FRA, June 1998</p>	<p>Available from FRA</p>

94. Railroad Safety Statistics/Annual Report 1997 Prepared by FRA, September 1998	FRA Safety Website
95. Railroad Horn Systems Research Final Report Prepared by FRA, January 1999	Available from FRA
96. Freight Car Reflectorization Final Report Prepared by FRA, January 1999	Available from FRA
97. Railroad Safety Statistics Annual Report 1998 Prepared by FRA, August 1999	FRA Safety Website
98. Improving Railroad Safety and Rail Passenger Technology through Targeted Research and Demonstrations Prepared by FRA, 1992–1997, December 1999	Available from FRA
99. Compilation Of State Laws and Regulations Affecting Highway-Rail Crossings, Third Edition by L. Stephen Jennings and Applied System Technologies, January 6, 2000	Not available See Item 108
100. Railroad Safety Statistics Annual Report 1999 Prepared by FRA Office of Safety, August 2000	PB 2002104298 FRA Safety Website
101. Report On High Risk Crossing and Mitigation Efforts by State Office of Safety, FRA and FHWA Report H.R.2084, September 2000	FRA Safety Website
102. Project Plan 1-800 Toll-Free Emergency Notification System for Shortline Railroad Highway-Rail Crossings in the Commonwealth of Pennsylvania, A Joint Partnership; September 20, 2000	FRA Safety Website
103. Railroad Safety Statistics Annual Report 2000 Prepared by Office of Safety, FRA, July 2001	FRA Safety Website
104. Recommended Traffic Control Devices for Railroad-Highway Grade Crossings, TRB Report Prepared by Lerner & Lianeras, Westat and McGee & Stephens, BMI, November 2001	Available from TRB
105. Intelligent Transportation Systems at Highway-Rail Intersections, A Cross-Cutting Study EDL# 13587 Prepared by DOT, December 2001	FHWA-OP-01-149
106. Five-Year Strategic Plan for Railroad Research, Development, and Demonstrations Prepared by FRA Report FRA/RDV-02/02, March 2002	PB 2002108029
107. Railroad Safety Statistics Annual Report 2001 Prepared by Office of Safety, FRA, July 2002	FRA Safety Website

108. Compilation Of State Laws and Regulations Affecting Highway-Rail Crossings, Fourth Edition by L. Stephen Jennings and Applied System Technologies, December 2002	FRA Safety Website
109. Safety of Highway-Railroad Grade Crossings by FRA Office of Research and Development, Office of Safety, February 2003	Available from FRA
110. Railroad Safety Statistics Annual Report 2002 by FRA Office of Safety, July 2003	FRA Safety Website
111. Final Environmental Impact Statement “Interim Final Rule for the Use of Locomotive Horns at Highway-Rail Grade Crossings” FRA, December 5, 2003	Available from FRA Office of Safety
112. FRA Guide for Preparing Accident/ Incident Reports 2003 FRA, Effective May 1, 2003	FRA Safety Website
113. Guidelines for Submitting Accident/ Incident Reports by Alternative Methods FRA	FRA Safety Website
114. Railroad Safety Statistics Annual Report 2003 (Prelim) by FRA Office of Safety, July 2004	FRA Safety Website
115. Secretary’s Action Plan for Highway-Rail Crossing Safety and Trespass Prevention, Office of Safety, FRA, June 7, 2004	FRA Safety Website
116. Evaluation of Alternative Detection Technologies for Trains and Highway Vehicles at Highway Rail Intersection DOT/FRA/ORD-03/04	Available from FRA Office of Research and Development
117. North Carolina DOT Traffic Separation Studies, Volume I – Assessment by Volpe DOT/FRA/ORD-04/15.I, September 2004, 52 pp.	Available from NTIS and FRA Office of Research and Development
118. North Carolina DOT Traffic Separation Studies, Volume II – Findings by Community by Volpe DOT/FRA/ORD-04/15.II, September 2004, 44 pp.	Available from NTIS and FRA Office of Research and Development
119. Rails-with-Trails: Lessons Learned FRA/FHWA/NHTSA/FTA by Volpe FTA-MA-26-0052-04-1, August 2002, 190 pp.	Available from FRA, FTA, NTIS and the FRA Website

120. Preemption of Traffic Signals Near Railroad Crossings
 Available from ITE
 ITE Committee TENC-99-06, August 1, 2004
 Final Draft

Published FHWA Reports

(Federal Highway Administration, Office of Research and Development, Turner-Fairbank Highway Research Center, 6300 Georgetown Pike, McLean, Virginia 22101)

1. Motorists' Requirements for Active Grade Crossing Warning Devices FHWA-RD-77-167	PB 296183	A12
2. Railroad Grade Crossing Passive Signing Study—Final Report FHWA-RD-78-34	PB 286528	A04
3. Safety Features of Stop Signs at Rail-Highway Grade Crossings Vol. 1 Executive Summary FHWA-RD -78-40	PB 295422	A02
Vol. 2 Technical Report FHWA-RD-78-41	PB 295423	A08
4. Experimental Design for Active Grade Crossing Warning Devices FHWA-RD-77-167	PB 80-145089	A04
5. Railroad-Highway Grade Crossing Handbook FHWA-TS-78-214 (See Item 19)	PB 86-127644	A12
6. Rail-Highway Crossing Accident Causation Study Vol. I Executive Summary FHWA/RD-81-082	PB 83-158725	A03
7. Rail-Highway Crossing Accident Causation Study Vol. II Technical Report FHWA/RD-81-083	PB 83-158733	A07
8. Activated Advance Warning for Railroad Crossings FHWA/RD-80-003	PB 83-161869	A09
9. Report to Congress. Railroad-Highway Safety Part I: A Comprehensive Statement of the Problem Part II: Recommendations for Resolving the Problem Prepared jointly by the staffs of FRA and FHWA November 1971 and August 1972	PB 206792 PB 213115	A07 A06

10. The Effectiveness of Automatic Protection in Reducing Accident Frequency and Severity at Public Grade Crossings in California Prepared by the California Public Utilities Commission Transportation Division, June 1974 Reprinted for FHWA, August 1975	Available from FHWA	
11. The Effectiveness of Flashing Lights and Flashing Lights with Gates in Reducing Accident Frequency at Public Rail-Highway Crossings, 1975–1978 Prepared by Input Output Computer Services, Inc. for TSC/FRA/FHWA Report FRA-RRS-80-005, April 1980	PB 81-133886	A03
12. Rail-Highway Crossing Warning Device Life Cycle Cost Analysis Prepared by Input Output Computer Services, Inc. for TSC/FRA/FHWA Report FRA-RRS-80-003, September 1980	PB 81-133894	A05
13. Rail-Highway Crossing Resource Allocation Model Prepared by TSC for FRA/FHWA Report FRA-RRS-81-001, April 1981	PB 81-212540	A05
14. Proceedings, 1982 Railroad-Highway Safety National Conference, Kansas City, Missouri, August 31–September 2, 1982	PB 83-163501	A10
15. Rail-Highway Crossing Resource Allocation Procedure User's Guide Prepared by TSC for FHWA and FRA Report FHWA-IP-82-7, December 1982	Not available See FRA Item 57	
16. Compilation of State Laws and Regulations On Matters Affecting Rail-Highway Crossings Prepared by KSU for AAR, FRA and FHWA Report FHWA-TS-83-203, April 1983	Not available See FRA Item 108	
17. Accident Severity Prediction Formula for Rail-Highway Crossings Prepared by TSC for FRA and FHWA Report FHWA-RD-83/092, July 1984	PB 85-107167	A03
18. Proceedings, 1985 National Conference on Highway-Rail Safety, Kansas City, Missouri, July 16-18, 1985	PB 86-148731	A10
19. Constant Warning Time Devices for Railroad-Highway Crossings Prepared by Goodell-Grivas, Inc. Report FHWA/RD-86/156, December 1985	PB 86-209715	A06
20. Consequences of Mandatory Stops at Railroad-Highway Crossings Prepared by Goodell-Grivas, Inc. Report FHWA/RD-86/014, December 1985	PB 86-179579	A09

21. Effectiveness of Motorist Warning Devices at Rail-Highway Crossings Prepared by TSC for FRA and FHWA Report FHWA/RD-85/015, April 1985	PB 88-225990/AS	A05
22. Rail-Highway Crossing Resource Allocation Procedure – User’s Guide – Second Edition Prepared by TSC for FRA and FHWA Report FHWA-IP-86-11, July 1986	No longer available See FRA Item 57	
23. Railroad Crossing Corridor Improvements, A Model Program Based on Field Reviews in Six States Report FHWA-DP-70-1, June 1986	PB 87-119673/AS	A05
24. Railroad-Highway Grade Crossing Handbook, Second Edition FHWA Safety Website Report FHWA-TS-86-215, September 1986	PB 87-137527	A10
25. Evaluation of Methods for Predicting Rail-Highway Crossing Hazards Prepared by Virginia Highway and Transportation Research Council Report FHWA/VA-86/32, March 1986	PB 86-213808	A03
26. Railroad-Highway Grade Crossing Signal Visibility Improvement Program Vol. 1 - Final Report FHWA-RD-86-186, July 1987 Vol. 2 - Hardware User’s Guide FHWA-RD-86-188, July 1987 Vol. 3 - Data and Hardware Details FHWA-RD-86-187	PB 88-130216/AS PB 88-130224/AS PB 88-130232/AS	A05 A05 A05
27. Field Evaluation of Innovative Active Warning Devices for Use at Railroad-Highway Grade Crossings Prepared by University of Tennessee for FHWA, Publication FHWA-RD-88-135, August 1988	PB 89-163141	A13
28. Updated Compilation of States’ Laws and Regulations Affecting Driver Behavior at Rail-Highway Crossings Prepared by COMSIS Corp., for FRA, FHWA Project DTFH61-88-Z-00145, February 1989	Not available See FRA Item 108	
29. Rail-Highway Crossing Study Report of the Secretary of Transportation to the U.S. Congress Publication FHWA-SA-89-001, April 1989	PB 90-125212/AS	A08
30. Driver Behavior at Rail-Highway Crossings Prepared by Comsis Corp. Report FHWA-82-90-008, June 1990	PB 90-241118/ABS	

31. Warning Time Requirements At Railroad-Highway Grade Crossings With Active Traffic Control
 Prepared by University of Tennessee for FHWA
 Report FHWA-SA-91-007, February 1991
 *on paper
 **on microfiche

PB 91-218289/AS
 A06*
 A01**

32. Part VI: Standards and Guides for Traffic Controls for Street and Highway Construction, Maintenance, Utility, and Incident Management Operations
 Part VI of the Manual on Uniform Traffic Control Devices (MUTCD), 2003

Available from FHWA

33. A Preliminary Laboratory Investigation of Passive Railroad Crossing Signs
 Prepared by Office of Safety and Traffic Operations R&D for FHWA
 Report No. FHWA-RD-93-153, December 1993

PB 94-184215

34. Highway-Railroad Grade Crossing: A Guide To Crossing Consolidation and Closure
 Prepared by FRA and FHWA
 FHWA-TS-86-2, July 1994

FRA Safety Website

35. Guidance On Traffic Control Devices at Highway-Rail Grade Crossings
 Technical Working Group,
 U.S. DOT, FHWA, November 2002
safety.fhwa.dot.gov/media/twgreport.htm

FHWA Website
 FRA Safety Website

Published NHTSA Reports

1. Human Factors Countermeasures to Improve Highway-Railway Intersection Safety
 Prepared by Bio Technology Inc. for FRA and NHTSA
 Report DOT-HS-800888, July 1973, 235 pp.

PB 223416
 A11

2. Feasibility Study of In-Vehicle Warning Systems
 Prepared by Tracor-Jitco for NHTSA/FRA
 Report DOT-HS-256-3-752, May 1975

PB 242462
 A07

3. Rail-Highway Crossing Safety: Fatal Crash and Demographic Descriptors
 Report DOT HS 808-196, November 1994

PB 95-188884
 A04

Published OST Reports

1. Accidents That Shouldn't Happen. Available from FRA
 A Report of the Grade Crossing Safety Task Force to Secretary Federico Pena
 Prepared by DOT Task Force, March 1996

2. Implementation Report of the U.S. DOT Available from FRA
 Grade Crossing Safety Task Force
 Prepared by DOT Task Force
 Publication FHWA-SA-97-085,
 HAS-20/7-97-97(1M)E, June 1997

Price code for documents in print:

(For full list and price coding, please refer to www.ntis.gov/pdf/pricode.pdf)

NTIS price schedules for documents in print:

Standard prices	Archival prices	Exception prices
A01* \$ 9.50	\$ 12.00	E01.....\$ 18.50
A02* \$ 14.00	\$ 17.50	E02\$ 23.00
A03 \$ 26.50	\$ 33.50	E03\$ 25.50
A04 \$ 29.50	\$ 37.00	E04\$ 30.00
A05 \$ 31.50	\$ 39.50	E05\$ 33.50
A06 \$ 34.00	\$ 42.50	E06\$ 37.00
A06 \$ 34.00	\$ 42.50	E06\$ 37.00
A07 \$ 38.00	\$ 47.50	E07\$ 41.50
A08 \$ 41.50	\$ 52.00	E08\$ 46.00
A09 \$ 47.50	\$ 59.50	E09\$ 51.00
A10 \$ 51.00	\$ 64.00	E10\$ 55.50
A11 \$ 54.50	\$ 68.50	E11\$ 60.00
A12 \$ 59.00	\$ 74.00	E12\$ 66.00
A13 \$ 62.50	\$ 78.50	E13\$ 70.50

* A01 for standard microfiche is \$14.00; \$17.50 for out-of-print microfiche.

* A02 for standard microfiche is \$20.00; \$25.00 for out-of-print microfiche.

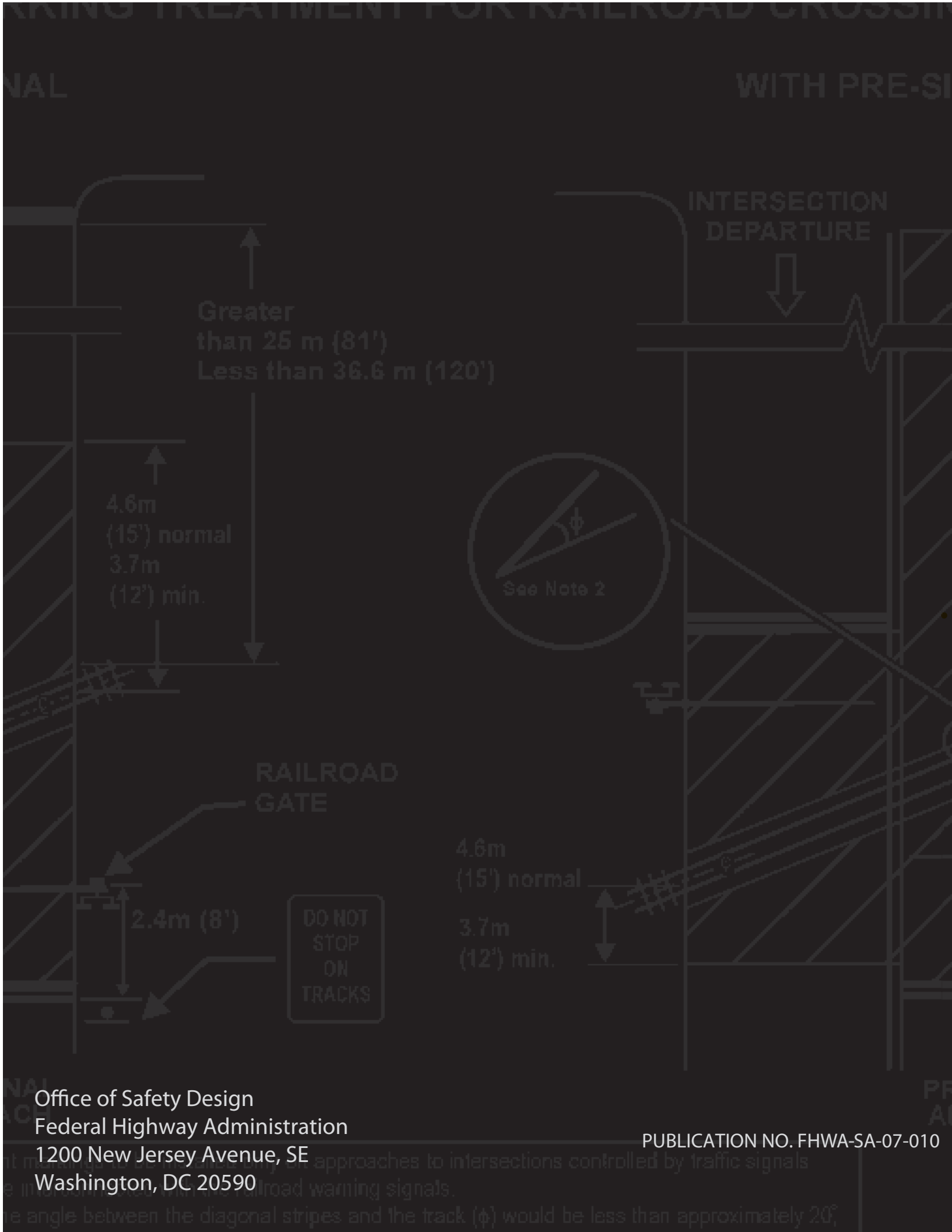

Office of Safety Design
 Federal Highway Administration
 1200 New Jersey Avenue, SE
 Washington, DC 20590

PUBLICATION NO. FHWA-SA-07-010

... approaches to intersections controlled by traffic signals
 ... railroad warning signals.

... the angle between the diagonal stripes and the track (ϕ) would be less than approximately 20°.